

Accurate Physical Layer Modeling for Realistic Wireless Network Simulation

The Need for Validation

Ruben Merz¹ Cigdem Sengul¹ Mustafa Al-Bado²

¹Deutsche Telekom Laboratories, TU Berlin

²FG INET, TU Berlin

Workshop on ns-3 (WNS-3) / March 2nd, 2009

Deutsche Telekom Laboratories
An-Institut der Technischen Universität Berlin



The Tension Between Accuracy and Complexity

Simulator objectives

- Short simulation time
- Accurate simulation results

Wireless network simulator

- Short simulation time = simplified models
- Lack of validation with real environments

We do Need Simulators. Hence Validation

Why do we need simulators

- Testbed: not necessary flexible, easily configurable
- Example: protocol validation before deployment, traces replaying for debugging

The Need for Validation

- Trustworthy wireless simulations: usable and dependable simulator
- Understand what the (valid) assumptions are
- Accuracy/networking point view: what must be modeled precisely, what can be dropped

A Typical 802.11a/b/g Transceiver

Wistron CM9 mini-PCI

<http://www.ipmedia.cz/img.asp?attid=655>

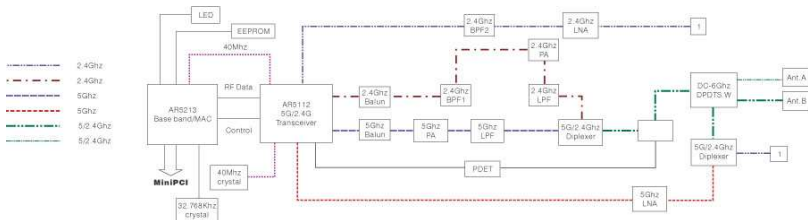

A Typical 802.11a/b/g Transceiver

Wistron CM9 mini-PCI

<http://www.ipmedia.cz/img.asp?attid=655>

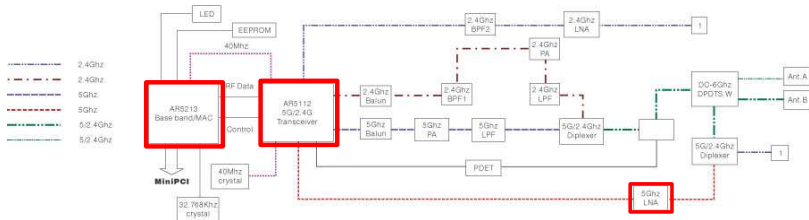

A Typical 802.11a/b/g Transceiver

Wistron CM9 mini-PCI

<http://www.ipmedia.cz/img.asp?attid=655>

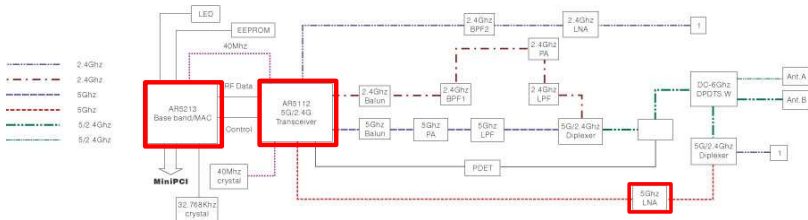

Atheros
5211/5111

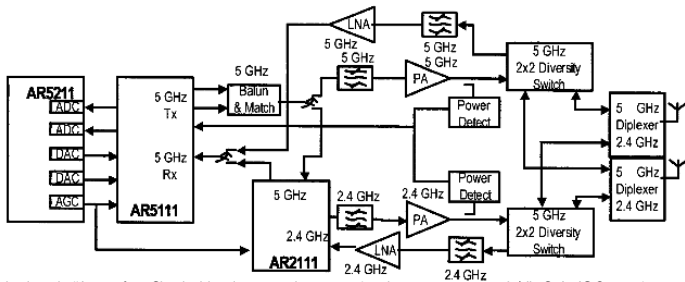

McFarland et al. "A 2.4 & 5 GHz dual band 802.11 wlan supporting data rates to 108 mb/s", GaAs IC Symposium, 2002

A Typical 802.11a/b/g Transceiver

Wistron CM9 mini-PCI

<http://www.ipmedia.cz/img.asp?attid=655>

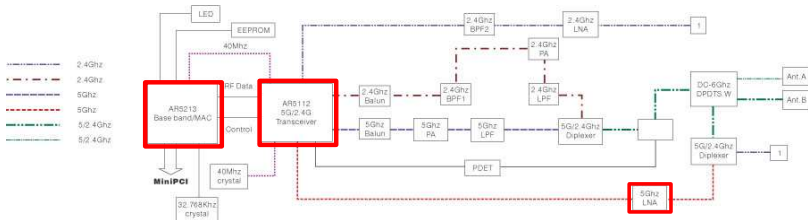

Atheros
5211/5111

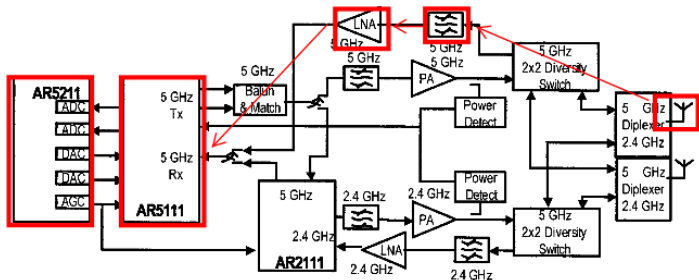

McFarland et al. "A 2.4 & 5 GHz dual band 802.11 wlan supporting data rates to 108 mb/s", GaAs IC Symposium, 2002

A Typical RF Frontend

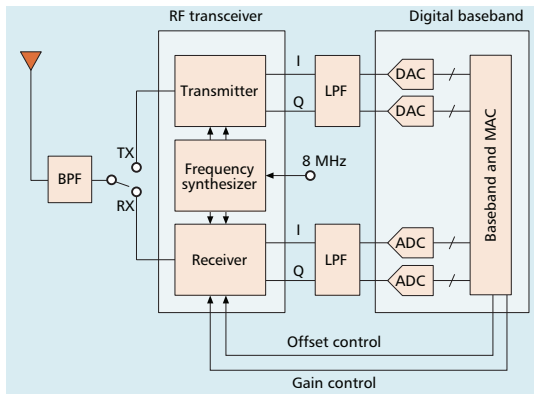

Meng et al. "Design and implementation of an all-CMOS 802.11a wireless LAN chipset", IEEE Communications Magazine, 2003

A Typical RF Frontend

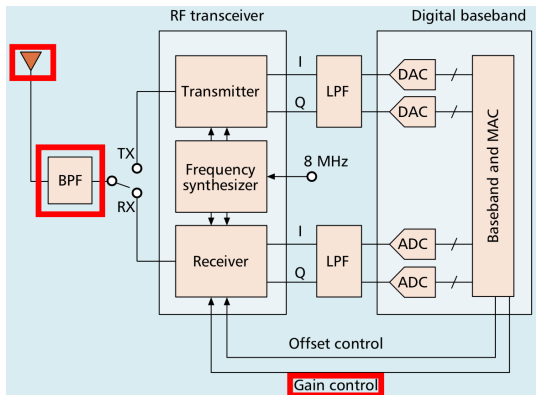

Meng et al. "Design and implementation of an all-CMOS 802.11a wireless LAN chipset", IEEE Communications Magazine, 2003

A Typical Baseband Engine

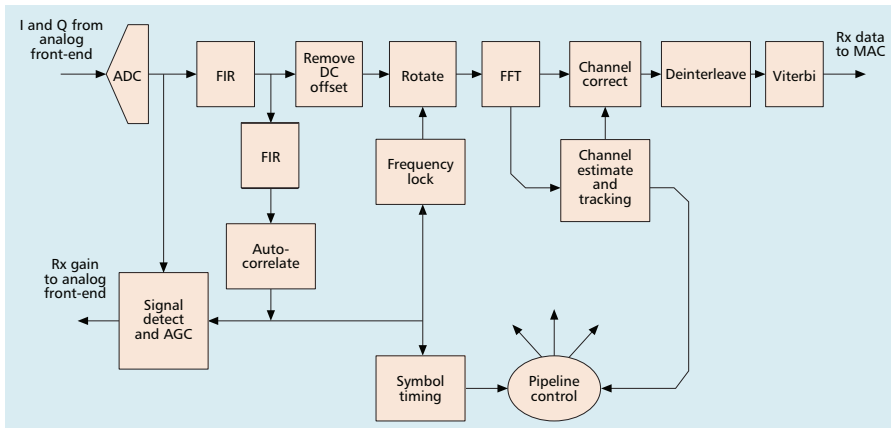

Meng et al. "Design and implementation of an all-CMOS 802.11a wireless LAN chipset", IEEE Communications Magazine, 2003

A Typical Baseband Engine

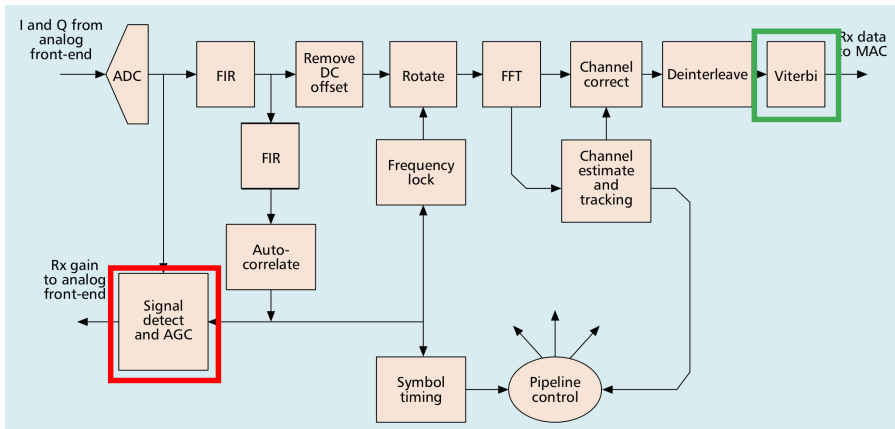

Meng et al. "Design and implementation of an all-CMOS 802.11a wireless LAN chipset", IEEE Communications Magazine, 2003

What do We Have in ns-3.3

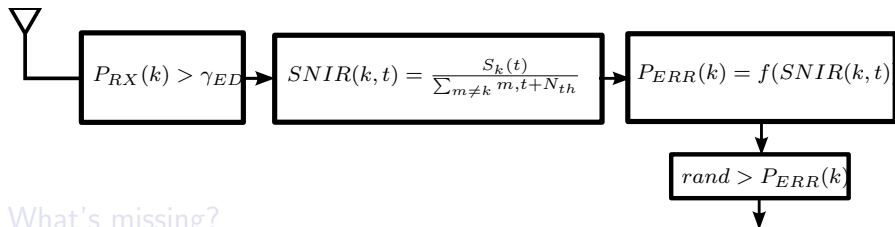

What's missing?

- Hardware specifics: RF frontend, non-standard transmission mode
- Multiple transmission channels
- Antenna modeling / Multiple Antennas
- Propagation
- Packet detection and timing acquisition (synchronization) / Capture

Is the existing model sufficient/accurate? How to model/validate?
What are the features that affects accuracy?

What do We Have in ns-3.3

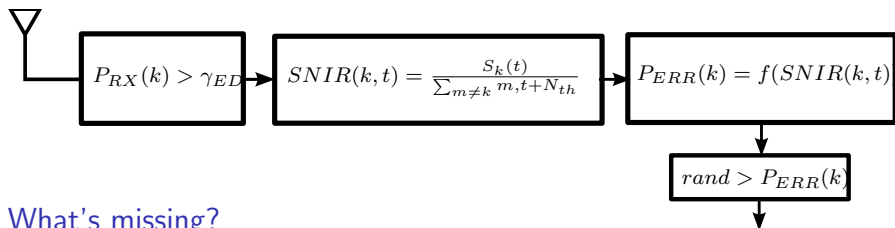

What's missing?

- Hardware specifics: RF frontend, non-standard transmission mode
- Multiple transmission channels
- Antenna modeling / Multiple Antennas
- Propagation
- Packet detection and timing acquisition (synchronization) / Capture

Is the existing model sufficient/accurate? How to model/validate?
What are the features that affects accuracy?

What do We Have in ns-3.3

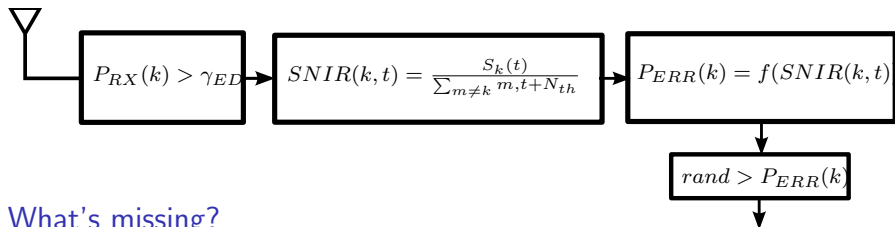

What's missing?

- Hardware specifics: RF frontend, non-standard transmission mode
- Multiple transmission channels
- Antenna modeling / Multiple Antennas
- Propagation
- Packet detection and timing acquisition (synchronization) / Capture

Is the existing model sufficient/accurate? How to model/validate?
What are the features that affects accuracy?

Accuracy Issue 1: Hardware Specifics

■ Power control granularity

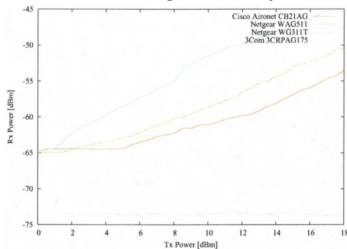

■ Output power spectrum not constant

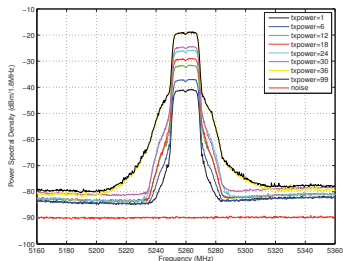

MADWIFI, CM9 mini-PCI

- Parameters dependent on transmission mode: output power, sensitivity
- Proprietary features: antenna diversity

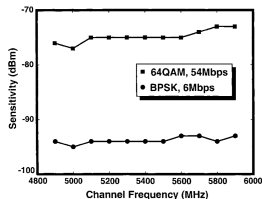

Kowalik et al., "Practical Issues of Power Control in IEEE 802.11 Wireless Devices", 2008

Cheng et al., "Adjacent Channel Interference in Dual-radio 802.11a Nodes and Its Impact on Multi-hop Networking", Globecom 06

Zargari et al., "A Single-Chip Dual-Band Tri-Mode CMOS Transceiver for IEEE 802.11a/b/g Wireless LAN", IEEE Journal of Solid-Circuits, 2004

Accuracy Issue 2: Multiple Transmission Channels

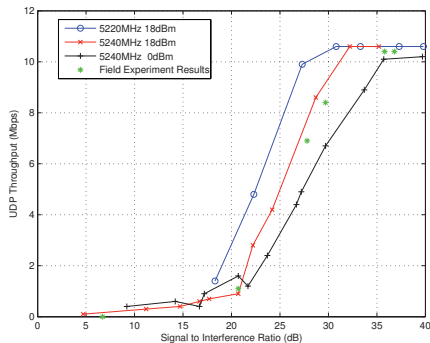
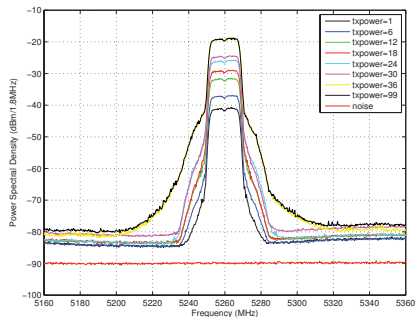

■ Channels are not orthogonal: ACI

Cheng et al., "Adjacent Channel Interference in Dual-radio 802.11a Nodes and Its Impact on Multi-hop Networking", Globecom 06

Accuracy Issue 3: Antenna Pattern, RF Frontend

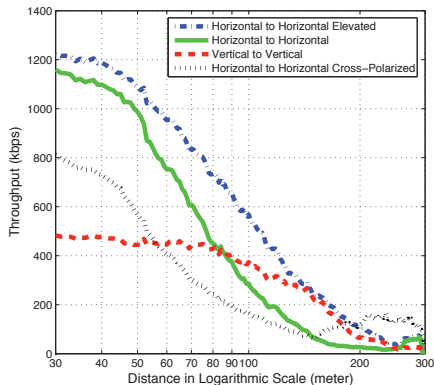
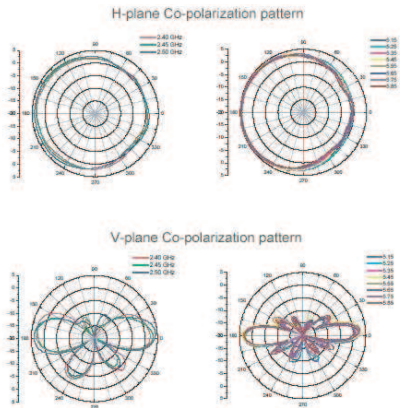

- Antennas: need orientation

Cheng et al., "Performance Measurement of 802.11a Wireless Links from UAV to Ground Nodes with Various Antenna Orientations", ICCCN 06

Accuracy Issue 4: Channel Propagation

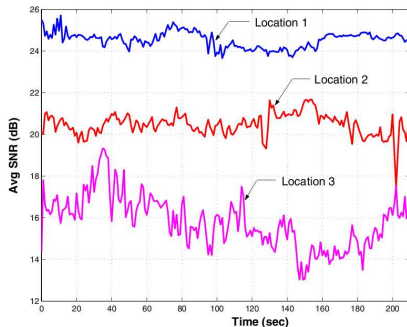
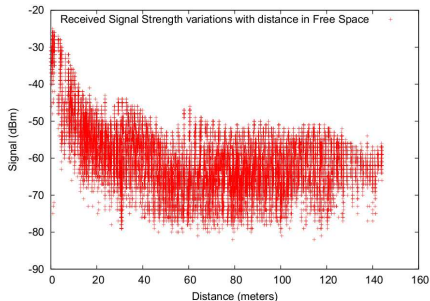

- Propagation is a random process
 - Environment specific: indoor/outdoor
 - Frequency specific
- Channels are not symmetric
- Space and time correlation

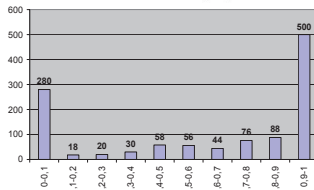

Reddy, Riley, "Measurement-Based Physical Layer Modeling for Wireless Network Simulations", MASCOTS 07
Vyas et al., "Characterization of an IEEE 802.11a Receiver using Measurements in an Indoor Environment", Globecom 06
Kurth et al., "Multi-Channel Link-level Measurements in 802.11 Mesh Networks", 2006

Accuracy Issue 5: Synchronization and Capture, Automatic Gain Control (AGC)

- Sync depends on SNR
- Performance of sync and decoding not equivalent
- With several transmitters: capture effects
- Effect of AGC unknown

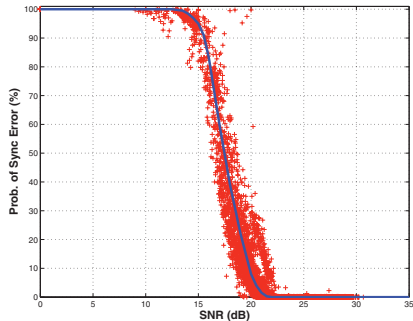

Vyas et al., "Characterization of an IEEE 802.11a Receiver using Measurements in an Indoor Environment", Globecom 06

Accuracy Issue 6: PER Computation

$$\begin{aligned}P_{ERR}(k) &= f(SNIR(k, t)) \\ &= 1 - \prod_l (1 - P_e(k, l))\end{aligned}$$

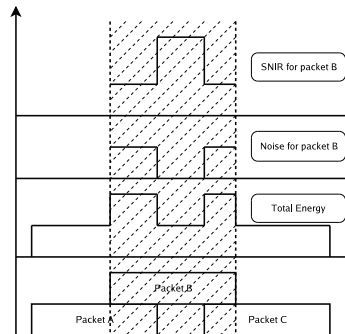

$SNIR(k, t)$ calculation

PER Computation

- Existing Viterbi models: AWGN or Rayleigh channels, upper-bounds, asymptotic performance
- OFDM modulation not modeled
- Validity of computation by block

What About ns-3.3

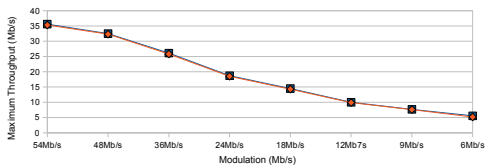

- Indoor LOS, 2 nodes, 15 m
- UDP, saturated

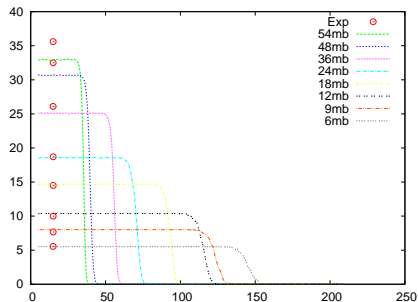

According to http://www.atheros.com/pt/whitepapers/Methodology_Testing_WLAN_Chariot.pdf, should be 30.5 Mbps

Outlook and Summary

Ongoing and Future work

- Channel modeling and validation
 - Ray-tracing?
 - Testbed in simulator
- Packet detection and timing acquisition validation, AGC
- PER calculation validation
 - Detailed, bit-level PHY for 802.11

Large scale validation with network traces

PHY: need modeling and validation

- Exhibit clearly what the underlying assumptions are
- What are the elements of importance for the overall simulation accuracy?