



## **ns-3 Model Library**

*Release ns-3-dev*

**ns-3 project**

Jan 09, 2021



# CONTENTS

<b>1</b>	<b>Organization</b>	<b>3</b>
<b>2</b>	<b>Animation</b>	<b>5</b>
<b>3</b>	<b>Antenna Module</b>	<b>13</b>
<b>4</b>	<b>Ad Hoc On-Demand Distance Vector (AODV)</b>	<b>17</b>
<b>5</b>	<b>3GPP HTTP applications</b>	<b>19</b>
<b>6</b>	<b>Bridge NetDevice</b>	<b>27</b>
<b>7</b>	<b>BRITE Integration</b>	<b>29</b>
<b>8</b>	<b>Buildings Module</b>	<b>33</b>
<b>9</b>	<b>Click Modular Router Integration</b>	<b>47</b>
<b>10</b>	<b>CSMA NetDevice</b>	<b>51</b>
<b>11</b>	<b>DSDV Routing</b>	<b>57</b>
<b>12</b>	<b>DSR Routing</b>	<b>59</b>
<b>13</b>	<b>Emulation Overview</b>	<b>63</b>
<b>14</b>	<b>Energy Framework</b>	<b>67</b>
<b>15</b>	<b>File Descriptor NetDevice</b>	<b>73</b>
<b>16</b>	<b>Flow Monitor</b>	<b>81</b>
<b>17</b>	<b>Internet Models (IP, TCP, Routing, UDP, Internet Applications)</b>	<b>87</b>
<b>18</b>	<b>Low-Rate Wireless Personal Area Network (LR-WPAN)</b>	<b>157</b>
<b>19</b>	<b>LTE Module</b>	<b>165</b>
<b>20</b>	<b>Wi-Fi Mesh Module Documentation</b>	<b>367</b>
<b>21</b>	<b>MPI for Distributed Simulation</b>	<b>371</b>
<b>22</b>	<b>Mobility</b>	<b>377</b>

<b>23 Network Module</b>	<b>385</b>
<b>24 Nix-Vector Routing Documentation</b>	<b>411</b>
<b>25 Optimized Link State Routing (OLSR)</b>	<b>413</b>
<b>26 OpenFlow switch support</b>	<b>417</b>
<b>27 PointToPoint NetDevice</b>	<b>421</b>
<b>28 Propagation</b>	<b>425</b>
<b>29 Spectrum Module</b>	<b>441</b>
<b>30 6LoWPAN: Transmission of IPv6 Packets over IEEE 802.15.4 Networks</b>	<b>453</b>
<b>31 Topology Input Readers</b>	<b>457</b>
<b>32 Traffic Control Layer</b>	<b>459</b>
<b>33 UAN Framework</b>	<b>489</b>
<b>34 WAVE models</b>	<b>501</b>
<b>35 Wi-Fi Module</b>	<b>515</b>
<b>36 Wimax NetDevice</b>	<b>553</b>
<b>Bibliography</b>	<b>563</b>
<b>Index</b>	<b>571</b>

This is the *ns-3 Model Library* documentation. Primary documentation for the ns-3 project is available in five forms:

- [ns-3 Doxygen](#): Documentation of the public APIs of the simulator
- Tutorial, Manual, and Model Library (*this document*) for the [latest release](#) and [development tree](#)
- [ns-3 wiki](#)

This document is written in `reStructuredText` for `Sphinx` and is maintained in the `doc/models` directory of ns-3's source code.



## ORGANIZATION

This manual compiles documentation for *ns-3* models and supporting software that enable users to construct network simulations. It is important to distinguish between **modules** and **models**:

- *ns-3* software is organized into separate *modules* that are each built as a separate software library. Individual *ns-3* programs can link the modules (libraries) they need to conduct their simulation.
- *ns-3 models* are abstract representations of real-world objects, protocols, devices, etc.

An *ns-3* module may consist of more than one model (for instance, the `internet` module contains models for both TCP and UDP). In general, *ns-3* models do not span multiple software modules, however.

This manual provides documentation about the models of *ns-3*. It complements two other sources of documentation concerning models:

- the model APIs are documented, from a programming perspective, using [Doxygen](#). Doxygen for *ns-3* models is available [on the project web server](#).
- the *ns-3* core is documented in the developer's manual. *ns-3* models make use of the facilities of the core, such as attributes, default values, random numbers, test frameworks, etc. Consult the [main web site](#) to find copies of the manual.

Finally, additional documentation about various aspects of *ns-3* may exist on the [project wiki](#).

A sample outline of how to write model library documentation can be found by executing the `create-module.py` program and looking at the template created in the file `new-module/doc/new-module.rst`.

```
$ cd src
$ ./create-module.py new-module
```

The remainder of this document is organized alphabetically by module name.

If you are new to *ns-3*, you might first want to read below about the network module, which contains some fundamental models for the simulator. The packet model, models for different address formats, and abstract base classes for objects such as nodes, net devices, channels, sockets, and applications are discussed there.





## ANIMATION

Animation is an important tool for network simulation. While *ns-3* does not contain a default graphical animation tool, we currently have two ways to provide animation, namely using the PyViz method or the NetAnim method. The PyViz method is described in <http://www.nsnam.org/wiki/PyViz>.

We will describe the NetAnim method briefly here.

### 2.1 NetAnim

NetAnim is a standalone, Qt4-based software executable that uses a trace file generated during an *ns-3* simulation to display the topology and animate the packet flow between nodes.

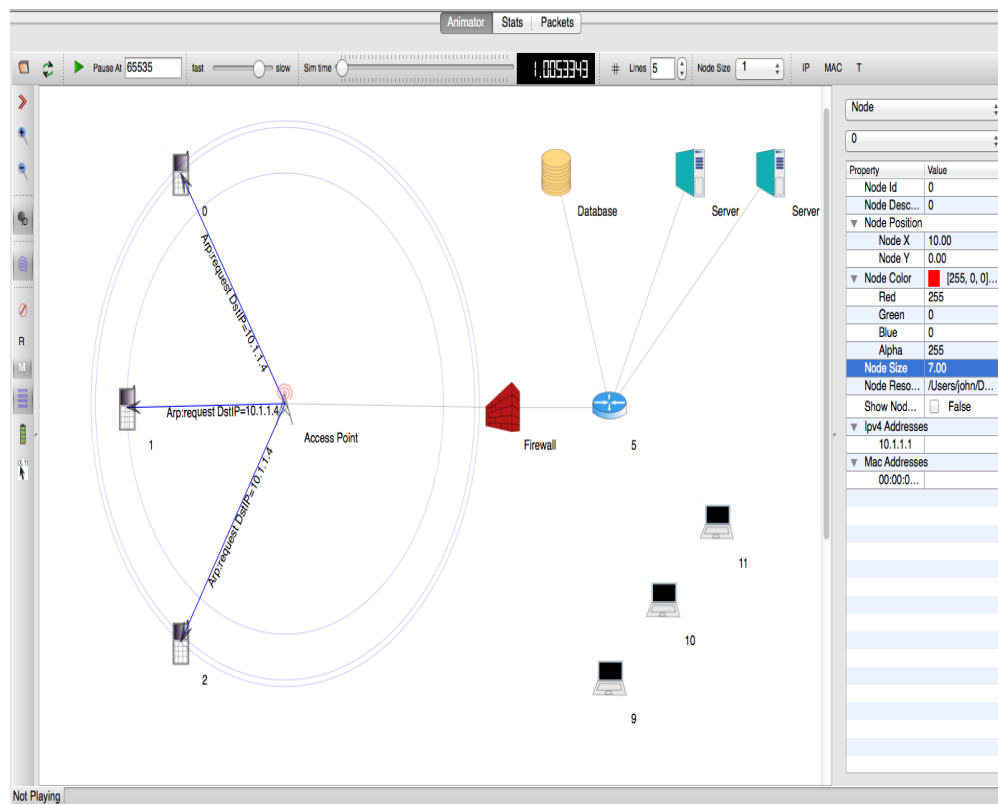

Fig. 1: An example of packet animation on wired-links

In addition, NetAnim also provides useful features such as tables to display meta-data of packets like the image below

	Tx Time	From Node Id	To Node Id	Meta Info
1	0.0301008	1	0	TCP 50000 > 49153 SYN ACK Seq=0 Ack=1 Win=65535
2	0.0711264	1	0	TCP 50000 > 49153 ACK Seq=1 Ack=537 Win=65535
3	0.112581	1	0	TCP 50000 > 49153 ACK Seq=1 Ack=1609 Win=65535
4	0.154035	1	0	TCP 50000 > 49153 ACK Seq=1 Ack=2681 Win=65535
5	0.195027	1	0	TCP 50000 > 49153 ACK Seq=1 Ack=3753 Win=65535
6	0.195952	1	0	TCP 50000 > 49153 ACK Seq=1 Ack=4825 Win=65535
7	0.236482	1	0	TCP 50000 > 49153 ACK Seq=1 Ack=5897 Win=65535
8	0.237406	1	0	TCP 50000 > 49153 ACK Seq=1 Ack=6969 Win=65535
9	0.238331	1	0	TCP 50000 > 49153 ACK Seq=1 Ack=8041 Win=65535
10	0.277936	1	0	TCP 50000 > 49153 ACK Seq=1 Ack=9113 Win=65535
11	0.278861	1	0	TCP 50000 > 49153 ACK Seq=1 Ack=10185 Win=65535
12	0.279786	1	0	TCP 50000 > 49153 ACK Seq=1 Ack=11257 Win=65535
13	0.28071	1	0	TCP 50000 > 49153 ACK Seq=1 Ack=12329 Win=65535
14	0.318928	1	0	TCP 50000 > 49153 ACK Seq=1 Ack=13401 Win=65535
15	0.319853	1	0	TCP 50000 > 49153 ACK Seq=1 Ack=14473 Win=65535
16	0.320778	1	0	TCP 50000 > 49153 ACK Seq=1 Ack=15545 Win=65535
17	0.321702	1	0	TCP 50000 > 49153 ACK Seq=1 Ack=16617 Win=65535
18	0.322627	1	0	TCP 50000 > 49153 ACK Seq=1 Ack=17689 Win=65535
19	0.323552	1	0	TCP 50000 > 49153 ACK Seq=1 Ack=18761 Win=65535
20	0.35992	1	0	TCP 50000 > 49153 ACK Seq=1 Ack=19833 Win=65535
21	0.360845	1	0	TCP 50000 > 49153 ACK Seq=1 Ack=20905 Win=65535
22	0.36177	1	0	TCP 50000 > 49153 ACK Seq=1 Ack=21977 Win=65535
23	0.362694	1	0	TCP 50000 > 49153 ACK Seq=1 Ack=23049 Win=65535

Fig. 2: An example of tables for packet meta-data with protocol filters

A way to visualize the trajectory of a mobile node

A way to display the routing-tables of multiple nodes at various points in time

A way to display counters associated with multiple nodes as a chart or a table

A way to view the timeline of packet transmit and receive events

## 2.1.1 Methodology

The class `ns3::AnimationInterface` is responsible for the creation the trace XML file. `AnimationInterface` uses the tracing infrastructure to track packet flows between nodes. `AnimationInterface` registers itself as a trace hook for tx and rx events before the simulation begins. When a packet is scheduled for transmission or reception, the corresponding tx and rx trace hooks in `AnimationInterface` are called. When the rx hooks are called, `AnimationInterface` will be aware of the two endpoints between which a packet has flowed, and adds this information to the trace file, in XML format along with the corresponding tx and rx timestamps. The XML format will be discussed in a later section. It is important to note that `AnimationInterface` records a packet only if the rx trace hooks are called. Every tx event must be matched by an rx event.

## 2.1.2 Downloading NetAnim

If NetAnim is not already available in the `ns-3` package you downloaded, you can do the following:

Please ensure that you have installed mercurial. The latest version of NetAnim can be downloaded using mercurial with the following command:

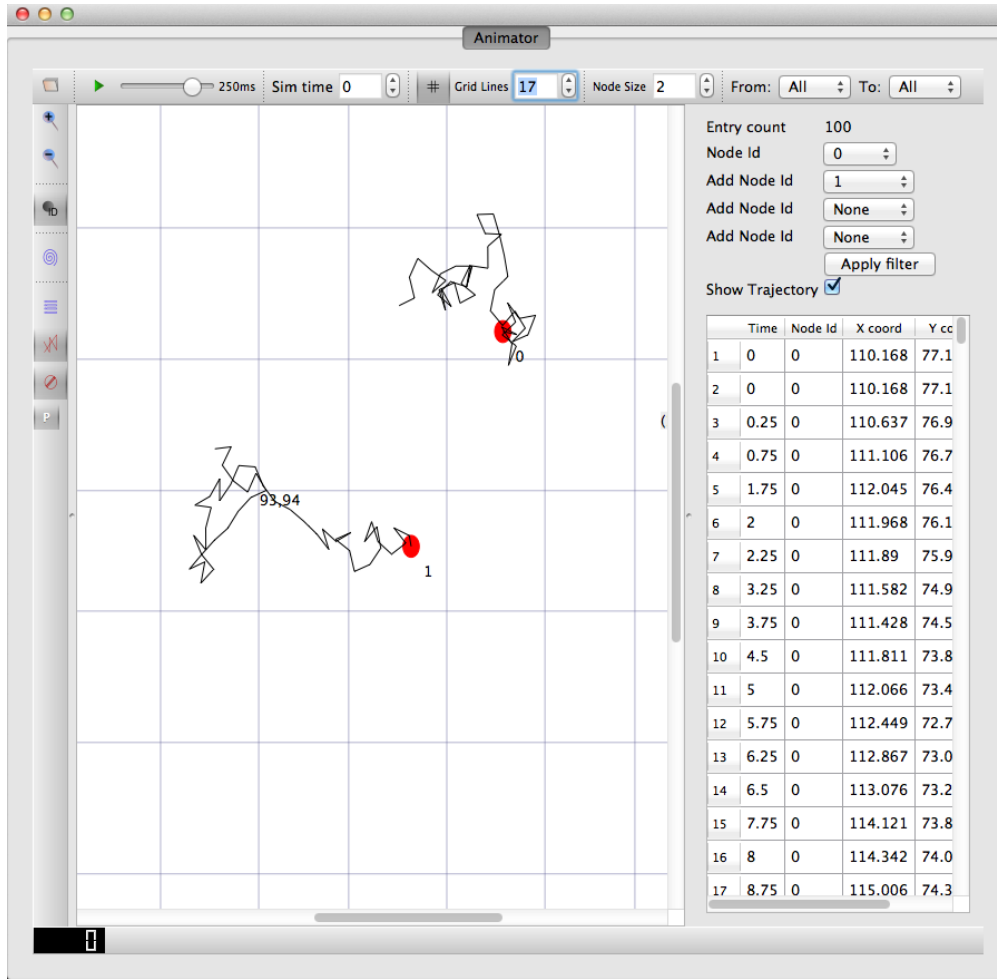
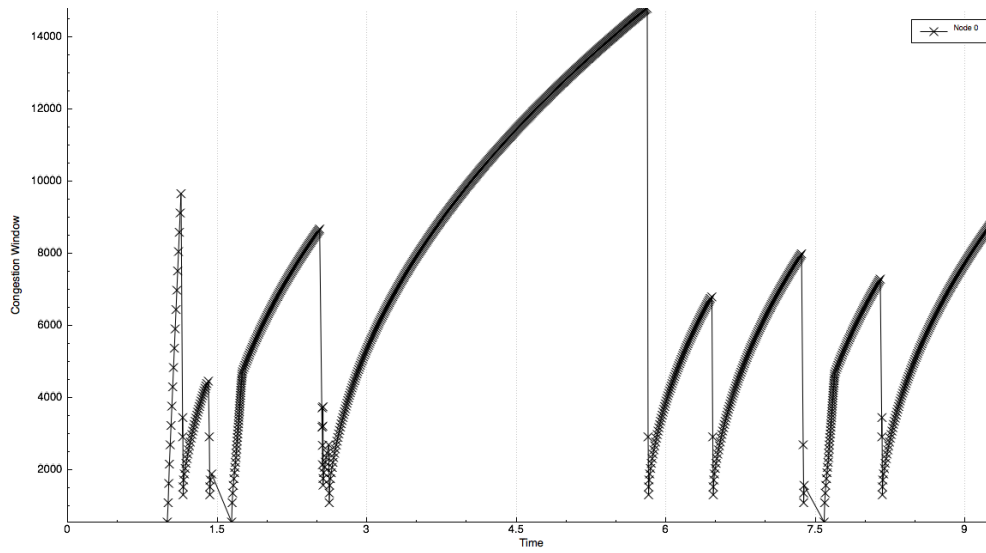

Fig. 3: An example of the trajectory of a mobile node

Node: 0 Time: 0s Ipv4ListRouting table						Node: 1 Time: 0s Ipv4ListRouting table						Node: 2 Time: 0s Ipv4ListRouting table											
Priority: 0 Protocol: ns3-ipv4StaticRouting						Priority: 0 Protocol: ns3-ipv4StaticRouting						Priority: 0 Protocol: ns3-ipv4StaticRouting											
Destination	Gateway	Genmask	Flags	Metric	Ref	Use	iface	Destination	Gateway	Genmask	Flags	Metric	Ref	Use	iface	Destination	Gateway	Genmask	Flags	Metric	Ref	Use	iface
127.0.0.0	0.0.0.0	255.0.0.0	U	0	-	-	0	127.0.0.0	0.0.0.0	255.0.0.0	U	0	-	-	0	127.0.0.0	0.0.0.0	255.0.0.0	U	0	-	-	0
10.1.3.0	0.0.0.0	255.255.255.0	U	0	-	-	1	10.1.3.0	0.0.0.0	255.255.255.0	U	0	-	-	1	10.1.3.0	0.0.0.0	255.255.255.0	U	0	-	-	1
Priority: -10 Protocol: ns3-ipv4GlobalRouting						Priority: -10 Protocol: ns3-ipv4GlobalRouting						Priority: -10 Protocol: ns3-ipv4GlobalRouting											
10.1.1.1	10.1.3.21	255.255.255.255	UH	-	-	-	1	10.1.1.1	10.1.3.21	255.255.255.255	UH	-	-	-	1	10.1.1.1	10.1.3.21	255.255.255.255	UH	-	-	-	1
10.1.1.2	10.1.3.21	255.255.255.255	UH	-	-	-	1	10.1.1.2	10.1.3.21	255.255.255.255	UH	-	-	-	1	10.1.1.2	10.1.3.21	255.255.255.255	UH	-	-	-	1
10.1.3.0	0.0.0.0	255.255.255.0	U	-	-	-	1	10.1.3.0	0.0.0.0	255.255.255.0	U	-	-	-	1	10.1.3.0	0.0.0.0	255.255.255.0	U	-	-	-	1
10.1.2.0	10.1.3.21	255.255.255.0	UG	-	-	-	1	10.1.2.0	10.1.3.21	255.255.255.0	UG	-	-	-	1	10.1.2.0	10.1.3.21	255.255.255.0	UG	-	-	-	1
127.0.0.0	10.1.3.2	255.0.0.0	UG	-	-	-	1	127.0.0.0	10.1.3.1	255.0.0.0	UG	-	-	-	1	127.0.0.0	10.1.3.1	255.0.0.0	UG	-	-	-	1
127.0.0.0	10.1.3.3	255.0.0.0	UG	-	-	-	1	127.0.0.0	10.1.3.3	255.0.0.0	UG	-	-	-	1	127.0.0.0	10.1.3.2	255.0.0.0	UG	-	-	-	1
127.0.0.0	10.1.3.4	255.0.0.0	UG	-	-	-	1	127.0.0.0	10.1.3.4	255.0.0.0	UG	-	-	-	1	127.0.0.0	10.1.3.4	255.0.0.0	UG	-	-	-	1
127.0.0.0	10.1.3.5	255.0.0.0	UG	-	-	-	1	127.0.0.0	10.1.3.5	255.0.0.0	UG	-	-	-	1	127.0.0.0	10.1.3.5	255.0.0.0	UG	-	-	-	1
127.0.0.0	10.1.3.6	255.0.0.0	UG	-	-	-	1	127.0.0.0	10.1.3.6	255.0.0.0	UG	-	-	-	1	127.0.0.0	10.1.3.6	255.0.0.0	UG	-	-	-	1
127.0.0.0	10.1.3.7	255.0.0.0	UG	-	-	-	1	127.0.0.0	10.1.3.7	255.0.0.0	UG	-	-	-	1	127.0.0.0	10.1.3.7	255.0.0.0	UG	-	-	-	1
127.0.0.0	10.1.3.8	255.0.0.0	UG	-	-	-	1	127.0.0.0	10.1.3.8	255.0.0.0	UG	-	-	-	1	127.0.0.0	10.1.3.8	255.0.0.0	UG	-	-	-	1
127.0.0.0	10.1.3.9	255.0.0.0	UG	-	-	-	1	127.0.0.0	10.1.3.9	255.0.0.0	UG	-	-	-	1	127.0.0.0	10.1.3.9	255.0.0.0	UG	-	-	-	1
127.0.0.0	10.1.3.10	255.0.0.0	UG	-	-	-	1	127.0.0.0	10.1.3.10	255.0.0.0	UG	-	-	-	1	127.0.0.0	10.1.3.10	255.0.0.0	UG	-	-	-	1
127.0.0.0	10.1.3.11	255.0.0.0	UG	-	-	-	1	127.0.0.0	10.1.3.11	255.0.0.0	UG	-	-	-	1	127.0.0.0	10.1.3.11	255.0.0.0	UG	-	-	-	1
127.0.0.0	10.1.3.12	255.0.0.0	UG	-	-	-	1	127.0.0.0	10.1.3.12	255.0.0.0	UG	-	-	-	1	127.0.0.0	10.1.3.12	255.0.0.0	UG	-	-	-	1
127.0.0.0	10.1.3.13	255.0.0.0	UG	-	-	-	1	127.0.0.0	10.1.3.13	255.0.0.0	UG	-	-	-	1	127.0.0.0	10.1.3.13	255.0.0.0	UG	-	-	-	1
127.0.0.0	10.1.3.14	255.0.0.0	UG	-	-	-	1	127.0.0.0	10.1.3.14	255.0.0.0	UG	-	-	-	1	127.0.0.0	10.1.3.14	255.0.0.0	UG	-	-	-	1
127.0.0.0	10.1.3.15	255.0.0.0	UG	-	-	-	1	127.0.0.0	10.1.3.15	255.0.0.0	UG	-	-	-	1	127.0.0.0	10.1.3.15	255.0.0.0	UG	-	-	-	1
127.0.0.0	10.1.3.16	255.0.0.0	UG	-	-	-	1	127.0.0.0	10.1.3.16	255.0.0.0	UG	-	-	-	1	127.0.0.0	10.1.3.16	255.0.0.0	UG	-	-	-	1
127.0.0.0	10.1.3.17	255.0.0.0	UG	-	-	-	1	127.0.0.0	10.1.3.17	255.0.0.0	UG	-	-	-	1	127.0.0.0	10.1.3.17	255.0.0.0	UG	-	-	-	1
127.0.0.0	10.1.3.18	255.0.0.0	UG	-	-	-	1	127.0.0.0	10.1.3.18	255.0.0.0	UG	-	-	-	1	127.0.0.0	10.1.3.18	255.0.0.0	UG	-	-	-	1
127.0.0.0	10.1.3.19	255.0.0.0	UG	-	-	-	1	127.0.0.0	10.1.3.19	255.0.0.0	UG	-	-	-	1	127.0.0.0	10.1.3.19	255.0.0.0	UG	-	-	-	1
127.0.0.0	10.1.3.20	255.0.0.0	UG	-	-	-	1	127.0.0.0	10.1.3.20	255.0.0.0	UG	-	-	-	1	127.0.0.0	10.1.3.20	255.0.0.0	UG	-	-	-	1
10.1.1.0	10.1.3.21	255.255.255.0	UG	-	-	-	1	10.1.1.0	10.1.3.21	255.255.255.0	UG	-	-	-	1	10.1.1.0	10.1.3.21	255.255.255.0	UG	-	-	-	1
127.0.0.0	10.1.3.21	255.0.0.0	UG	-	-	-	1	127.0.0.0	10.1.3.21	255.0.0.0	UG	-	-	-	1	127.0.0.0	10.1.3.21	255.0.0.0	UG	-	-	-	1
10.1.1.0	10.1.3.21	255.255.255.0	UG	-	-	-	1	10.1.1.0	10.1.3.21	255.255.255.0	UG	-	-	-	1	10.1.1.0	10.1.3.21	255.255.255.0	UG	-	-	-	1
127.0.0.0	10.1.3.21	255.0.0.0	UG	-	-	-	1	127.0.0.0	10.1.3.21	255.0.0.0	UG	-	-	-	1	127.0.0.0	10.1.3.21	255.0.0.0	UG	-	-	-	1
127.0.0.0	10.1.3.21	255.0.0.0	UG	-	-	-	1	127.0.0.0	10.1.3.21	255.0.0.0	UG	-	-	-	1	127.0.0.0	10.1.3.21	255.0.0.0	UG	-	-	-	1



Counter Tables    Sim Time    Font Size 10    FlowMon file    Double Counter 1

Export Table

	Time	0	1	2	3	4	5	6	7	8	9	10	11
1	0.1	134.532											
2	0.1					101.387							
3	0.2	164.6											
4	0.2					168.151							
5	0.3	154.444											
6	0.3					115.763							
7	0.4	179.264											
8	0.4					126.946							
9	0.5	144.204											
10	0.5					136.543							
11	0.6	116.857											
12	0.6					159.699							
13	0.7	174.138											
14	0.7					138.387							
15	0.8	101.934											
16	0.8					149.555							
17	0.9	195.25											
18	0.9					192.968							
19	1	132.337											
20	1					114.404							
21	1.1	142.992											
22	1.1					190.218							
23	1.2	122.185											

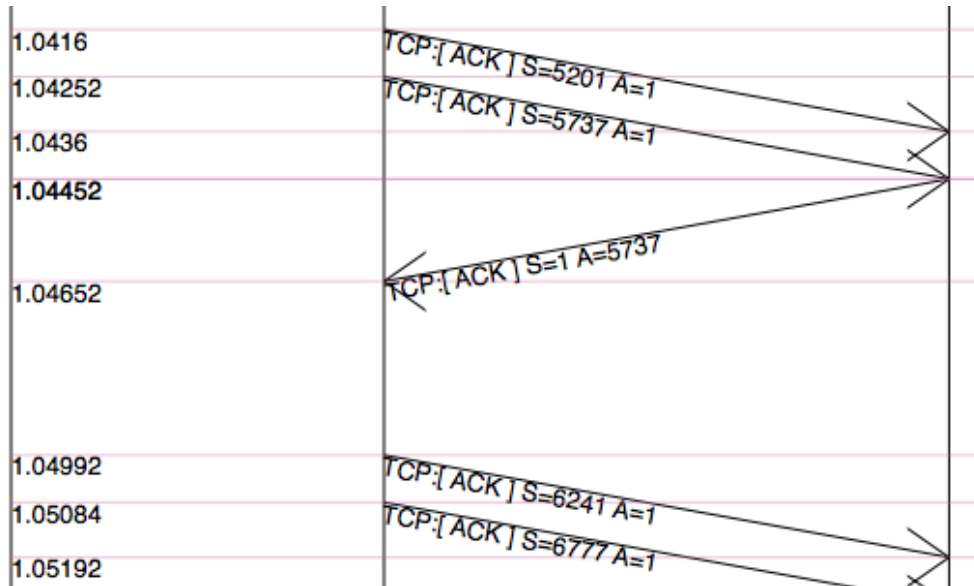

```
$ hg clone http://code.nsnam.org/netanim
```

## 2.1.3 Building NetAnim

### Prerequisites

Qt5 (5.4 and over) is required to build NetAnim. This can be obtained using the following ways:

For Ubuntu Linux distributions:

```
$ apt-get install qt5-default
```

For Red Hat/Fedora based distribution:

```
$ yum install qt5
$ yum install qt5-devel
```

For Mac/OSX, see <http://qt.nokia.com/downloads/>

### Build steps

To build NetAnim use the following commands:

```
$ cd netanim
$ make clean
$ qmake NetAnim.pro
$ make
```

Note: qmake could be “qmake-qt5” in some systems

This should create an executable named “NetAnim” in the same directory:

```
$ ls -l NetAnim
-rwxr-xr-x 1 john john 390395 2012-05-22 08:32 NetAnim
```

## 2.1.4 Usage

Using NetAnim is a two-step process

Step 1:Generate the animation XML trace file during simulation using “ns3::AnimationInterface” in the *ns-3* code base.

Step 2:Load the XML trace file generated in Step 1 with the offline Qt4-based animator named NetAnim.

### Step 1: Generate XML animation trace file

The class “AnimationInterface” under “src/netanim” uses underlying *ns-3* trace sources to construct a timestamped ASCII file in XML format.

Examples are found under src/netanim/examples Example:

```
$ ./waf -d debug configure --enable-examples
$ ./waf --run "dumbbell-animation"
```

The above will create an XML file dumbbell-animation.xml

### Mandatory

1. Ensure that your program’s wscript includes the “netanim” module. An example of such a wscript is at src/netanim/examples/wscript.
2. Include the header [#include “ns3/netanim-module.h”] in your test program
3. Add the statement

```
AnimationInterface anim ("animation.xml"); // where "animation.xml" is any arbitrary_
↳filename
```

[for versions before ns-3.13 you also have to use the line “anim.SetXMLOutput() to set the XML mode and also use anim.StartAnimation();]

### Optional

The following are optional but useful steps:

```
// Step 1
anim.SetMobilityPollInterval (Seconds (1));
```

AnimationInterface records the position of all nodes every 250 ms by default. The statement above sets the periodic interval at which AnimationInterface records the position of all nodes. If the nodes are expected to move very little, it is useful to set a high mobility poll interval to avoid large XML files.

```
// Step 2
anim.SetConstantPosition (Ptr< Node > n, double x, double y);
```

AnimationInterface requires that the position of all nodes be set. In *ns-3* this is done by setting an associated MobilityModel. “SetConstantPosition” is a quick way to set the x-y coordinates of a node which is stationary.

```
// Step 3
anim.SetStartTime (Seconds(150)); and anim.SetStopTime (Seconds(150));
```

AnimationInterface can generate large XML files. The above statements restricts the window between which AnimationInterface does tracing. Restricting the window serves to focus only on relevant portions of the simulation and creating manageably small XML files

```
// Step 4
AnimationInterface anim ("animation.xml", 50000);
```

Using the above constructor ensures that each animation XML trace file has only 50000 packets. For example, if AnimationInterface captures 150000 packets, using the above constructor splits the capture into 3 files

- animation.xml - containing the packet range 1-50000
- animation.xml-1 - containing the packet range 50001-100000
- animation.xml-2 - containing the packet range 100001-150000

```
// Step 5
anim.EnablePacketMetadata (true);
```

With the above statement, AnimationInterface records the meta-data of each packet in the xml trace file. Metadata can be used by NetAnim to provide better statistics and filter, along with providing some brief information about the packet such as TCP sequence number or source & destination IP address during packet animation.

CAUTION: Enabling this feature will result in larger XML trace files. Please do NOT enable this feature when using Wimax links.

```
// Step 6
anim.UpdateNodeDescription (5, "Access-point");
```

With the above statement, AnimationInterface assigns the text “Access-point” to node 5.

```
// Step 7
anim.UpdateNodeSize (6, 1.5, 1.5);
```

With the above statement, AnimationInterface sets the node size to scale by 1.5. NetAnim automatically scales the graphics view to fit the oboundaries of the topology. This means that NetAnim, can abnormally scale a node’s size too high or too low. Using AnimationInterface::UpdateNodeSize allows you to overwrite the default scaling in NetAnim and use your own custom scale.

```
// Step 8
anim.UpdateNodeCounter (89, 7, 3.4);
```

With the above statement, AnimationInterface sets the counter with Id == 89, associated with Node 7 with the value 3.4. The counter with Id 89 is obtained using AnimationInterface::AddNodeCounter. An example usage for this is in src/netanim/examples/resource-counters.cc.

## Step 2: Loading the XML in NetAnim

1. Assuming NetAnim was built, use the command “./NetAnim” to launch NetAnim. Please review the section “Building NetAnim” if NetAnim is not available.
2. When NetAnim is opened, click on the File open button at the top-left corner, select the XML file generated during Step 1.
3. Hit the green play button to begin animation.

Here is a video illustrating this [http://www.youtube.com/watch?v=tz\\_hUuNwFDs](http://www.youtube.com/watch?v=tz_hUuNwFDs)

## 2.1.5 Wiki

For detailed instructions on installing “NetAnim”, F.A.Qs and loading the XML trace file (mentioned earlier) using NetAnim please refer: <http://www.nsnam.org/wiki/NetAnim>



## ANTENNA MODULE

### 3.1 Design documentation

#### 3.1.1 Overview

The Antenna module provides:

1. a new base class (`AntennaModel`) that provides an interface for the modeling of the radiation pattern of an antenna;
2. a set of classes derived from this base class that each models the radiation pattern of different types of antennas;
3. the class `ThreeGppAntennaArrayModel`, which implements the antenna model described in 3GPP TR 38.901

#### 3.1.2 AntennaModel

The `AntennaModel` uses the coordinate system adopted in [Balanis] and depicted in Figure *Coordinate system of the AntennaModel*. This system is obtained by translating the Cartesian coordinate system used by the ns-3 `MobilityModel` into the new origin  $o$  which is the location of the antenna, and then transforming the coordinates of every generic point  $p$  of the space from Cartesian coordinates  $(x, y, z)$  into spherical coordinates  $(r, \theta, \phi)$ . The antenna model neglects the radial component  $r$ , and only considers the angle components  $(\theta, \phi)$ . An antenna radiation pattern is then expressed as a mathematical function  $g(\theta, \phi) \rightarrow \mathcal{R}$  that returns the gain (in dB) for each possible direction of transmission/reception. All angles are expressed in radians.

#### 3.1.3 Single antenna models

In this section we describe the antenna radiation pattern models that are included within the antenna module.

##### IsotropicAntennaModel

This antenna radiation pattern model provides a unitary gain (0 dB) for all direction.

##### CosineAntennaModel

This is the cosine model described in [Chunjian]: the antenna gain is determined as:

$$g(\phi, \theta) = \cos^n \left( \frac{\phi - \phi_0}{2} \right)$$

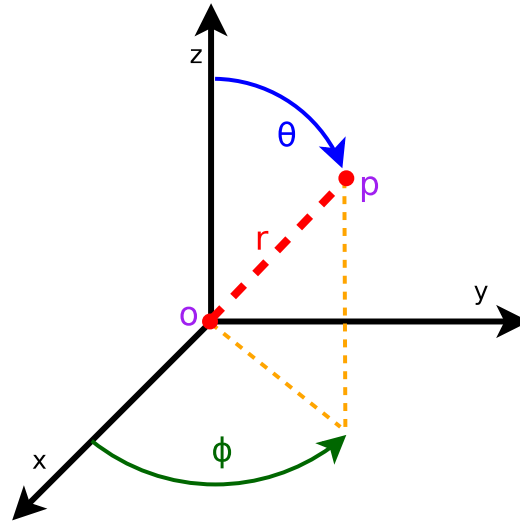

Fig. 1: Coordinate system of the AntennaModel

where  $\phi_0$  is the azimuthal orientation of the antenna (i.e., its direction of maximum gain) and the exponential

$$n = -\frac{3}{20 \log_{10} \left( \cos \frac{\phi_{3dB}}{4} \right)}$$

determines the desired 3dB beamwidth  $\phi_{3dB}$ . Note that this radiation pattern is independent of the inclination angle  $\theta$ .

A major difference between the model of [Chunjian] and the one implemented in the class CosineAntennaModel is that only the element factor (i.e., what described by the above formulas) is considered. In fact, [Chunjian] also considered an additional antenna array factor. The reason why the latter is excluded is that we expect that the average user would desire to specify a given beamwidth exactly, without adding an array factor at a latter stage which would in practice alter the effective beamwidth of the resulting radiation pattern.

### ParabolicAntennaModel

This model is based on the parabolic approximation of the main lobe radiation pattern. It is often used in the context of cellular system to model the radiation pattern of a cell sector, see for instance [R4-092042a] and [Calcev]. The antenna gain in dB is determined as:

$$g_{dB}(\phi, \theta) = -\min \left( 12 \left( \frac{\phi - \phi_0}{\phi_{3dB}} \right)^2, A_{max} \right)$$

where  $\phi_0$  is the azimuthal orientation of the antenna (i.e., its direction of maximum gain),  $\phi_{3dB}$  is its 3 dB beamwidth, and  $A_{max}$  is the maximum attenuation in dB of the antenna. Note that this radiation pattern is independent of the inclination angle  $\theta$ .

### 3.1.4 ThreeGppAntennaArrayModel

The class ThreeGppAntennaArrayModel implements the antenna model described in 3GPP TR 38.901<sup>38901</sup>, which is used by the classes ThreeGppSpectrumPropagationLossModel and ThreeGppChannelModel. Each instance of this class models an isotropic rectangular antenna array composed of a single panel with NxM elements, where N is

<sup>38901</sup> 3GPP. 2018. TR 38.901, Study on channel model for frequencies from 0.5 to 100 GHz, V15.0.0. (2018-06).

the number of rows and  $M$  is the number of columns, configurable through the attributes “NumRows” and “NumColumns”. The radiation pattern of the antenna elements follows the model specified in Sec. 7.3 of 3GPP TR 38.901; only vertical polarization is considered (i.e.,  $\zeta = 0$ ). The directional gain of the antenna elements can be configured through the attribute “ElementGain” (see formula 2.34 in [Mailloux] to choose a proper value). By default, the array is orthogonal to the x-axis, pointing towards the positive direction, but the orientation can be changed through the attributes “BearingAngle”, which adjusts the azimuth angle, and “DowntiltAngle”, which adjusts the elevation angle. The spacing between the horizontal and vertical elements can be configured through the attributes “AntennaHorizontalSpacing” and “AntennaVerticalSpacing”.

**Note:**

- Currently, the model does not support multi-panel antennas, i.e.,  $N_g = M_g = 1$ .
- Currently, the model supports only single polarized (i.e.,  $P = 1$ ) antenna panels with vertical polarization (i.e.,  $\zeta = 0$ )

## 3.2 User Documentation

The antenna modeled can be used with all the wireless technologies and physical layer models that support it. Currently, this includes the physical layer models based on the SpectrumPhy. Please refer to the documentation of each of these models for details.

## 3.3 Testing Documentation

In this section we describe the test suites included with the antenna module that verify its correct functionality.

### 3.3.1 Angles

The unit test suite `angles` verifies that the `Angles` class is constructed properly by correct conversion from 3D Cartesian coordinates according to the available methods (construction from a single vector and from a pair of vectors). For each method, several test cases are provided that compare the values  $(\phi, \theta)$  determined by the constructor to known reference values. The test passes if for each case the values are equal to the reference up to a tolerance of  $10^{-10}$  which accounts for numerical errors.

### 3.3.2 DegreesToRadians

The unit test suite `degrees-radians` verifies that the methods `DegreesToRadians` and `RadiansToDegrees` work properly by comparing with known reference values in a number of test cases. Each test case passes if the comparison is equal up to a tolerance of  $10^{-10}$  which accounts for numerical errors.

### 3.3.3 IsotropicAntennaModel

The unit test suite `isotropic-antenna-model` checks that the `IsotropicAntennaModel` class works properly, i.e., returns always a 0dB gain regardless of the direction.

### 3.3.4 CosineAntennaModel

The unit test suite `cosine-antenna-model` checks that the `CosineAntennaModel` class works properly. Several test cases are provided that check for the antenna gain value calculated at different directions and for different values of the orientation, the reference gain and the beamwidth. The reference gain is calculated by hand. Each test case passes if the reference gain in dB is equal to the value returned by `CosineAntennaModel` within a tolerance of 0.001, which accounts for the approximation done for the calculation of the reference values.

### 3.3.5 ParabolicAntennaModel

The unit test suite `parabolic-antenna-model` checks that the `ParabolicAntennaModel` class works properly. Several test cases are provided that check for the antenna gain value calculated at different directions and for different values of the orientation, the maximum attenuation and the beamwidth. The reference gain is calculated by hand. Each test case passes if the reference gain in dB is equal to the value returned by `ParabolicAntennaModel` within a tolerance of 0.001, which accounts for the approximation done for the calculation of the reference values.

## AD HOC ON-DEMAND DISTANCE VECTOR (AODV)

This model implements the base specification of the Ad Hoc On-Demand Distance Vector (AODV) protocol. The implementation is based on [RFC 3561](#).

The model was written by Elena Buchatskaia and Pavel Boyko of ITTP RAS, and is based on the ns-2 AODV model developed by the CMU/MONARCH group and optimized and tuned by Samir Das and Mahesh Marina, University of Cincinnati, and also on the AODV-UU implementation by Erik Nordström of Uppsala University.

### 4.1 Model Description

The source code for the AODV model lives in the directory *src/aodv*.

#### 4.1.1 Design

Class `ns3::aodv::RoutingProtocol` implements all functionality of service packet exchange and inherits from `ns3::Ipv4RoutingProtocol`. The base class defines two virtual functions for packet routing and forwarding. The first one, `ns3::aodv::RouteOutput`, is used for locally originated packets, and the second one, `ns3::aodv::RouteInput`, is used for forwarding and/or delivering received packets.

Protocol operation depends on many adjustable parameters. Parameters for this functionality are attributes of `ns3::aodv::RoutingProtocol`. Parameter default values are drawn from the RFC and allow the enabling/disabling protocol features, such as broadcasting HELLO messages, broadcasting data packets and so on.

AODV discovers routes on demand. Therefore, the AODV model buffers all packets while a route request packet (RREQ) is disseminated. A packet queue is implemented in `aodv-rqueue.cc`. A smart pointer to the packet, `ns3::Ipv4RoutingProtocol::ErrorCallback`, `ns3::Ipv4RoutingProtocol::UnicastForwardCallback`, and the IP header are stored in this queue. The packet queue implements garbage collection of old packets and a queue size limit.

The routing table implementation supports garbage collection of old entries and state machine, defined in the standard. It is implemented as a STL map container. The key is a destination IP address.

Some elements of protocol operation aren't described in the RFC. These elements generally concern cooperation of different OSI model layers. The model uses the following heuristics:

- This AODV implementation can detect the presence of unidirectional links and avoid them if necessary. If the node the model receives an RREQ for is a neighbor, the cause may be a unidirectional link. This heuristic is taken from AODV-UU implementation and can be disabled.
- Protocol operation strongly depends on broken link detection mechanism. The model implements two such heuristics. First, this implementation support HELLO messages. However HELLO messages are not a good way to perform neighbor sensing in a wireless environment (at least not over 802.11). Therefore, one may experience bad performance when running over wireless. There are several reasons for this: 1) HELLO messages

are broadcasted. In 802.11, broadcasting is often done at a lower bit rate than unicasting, thus HELLO messages can travel further than unicast data. 2) HELLO messages are small, thus less prone to bit errors than data transmissions, and 3) Broadcast transmissions are not guaranteed to be bidirectional, unlike unicast transmissions. Second, we use layer 2 feedback when possible. Link are considered to be broken if frame transmission results in a transmission failure for all retries. This mechanism is meant for active links and works faster than the first method.

The layer 2 feedback implementation relies on the `TxErrHeader` trace source, currently supported in `AdhocWifiMac` only.

### 4.1.2 Scope and Limitations

The model is for IPv4 only. The following optional protocol optimizations are not implemented:

1. Local link repair.
2. RREP, RREQ and HELLO message extensions.

These techniques require direct access to IP header, which contradicts the assertion from the AODV RFC that AODV works over UDP. This model uses UDP for simplicity, hindering the ability to implement certain protocol optimizations. The model doesn't use low layer raw sockets because they are not portable.

### 4.1.3 Future Work

No announced plans.

## 3GPP HTTP APPLICATIONS

### 5.1 Model Description

The model is a part of the applications library. The HTTP model is based on a commonly used 3GPP model in standardization [4].

#### 5.1.1 Design

This traffic generator simulates web browsing traffic using the Hypertext Transfer Protocol (HTTP). It consists of one or more `ThreeGppHttpClient` applications which connect to a `ThreeGppHttpServer` application. The client models a web browser which requests web pages to the server. The server is then responsible to serve the web pages as requested. Please refer to `ThreeGppHttpClientHelper` and `ThreeGppHttpServerHelper` for usage instructions.

Technically speaking, the client transmits *request objects* to demand a service from the server. Depending on the type of request received, the server transmits either:

- a *main object*, i.e., the HTML file of the web page; or
- an *embedded object*, e.g., an image referenced by the HTML file.

The main and embedded object sizes are illustrated in figures *3GPP HTTP main object size histogram* and *3GPP HTTP embedded object size histogram*.

A major portion of the traffic pattern is *reading time*, which does not generate any traffic. Because of this, one may need to simulate a good number of clients and/or sufficiently long simulation duration in order to generate any significant traffic in the system. Reading time is illustrated in *3GPP HTTP reading time histogram*.

#### 3GPP HTTP server description

3GPP HTTP server is a model application which simulates the traffic of a web server. This application works in conjunction with `ThreeGppHttpClient` applications.

The application works by responding to requests. Each request is a small packet of data which contains `ThreeGppHttpHeader`. The value of the *content type* field of the header determines the type of object that the client is requesting. The possible type is either a *main object* or an *embedded object*.

The application is responsible to generate the right type of object and send it back to the client. The size of each object to be sent is randomly determined (see `ThreeGppHttpVariables`). Each object may be sent as multiple packets due to limited socket buffer space.

To assist with the transmission, the application maintains several instances of `ThreeGppHttpServerTxBuffer`. Each instance keeps track of the object type to be served and the number of bytes left to be sent.

The application accepts connection request from clients. Every connection is kept open until the client disconnects.

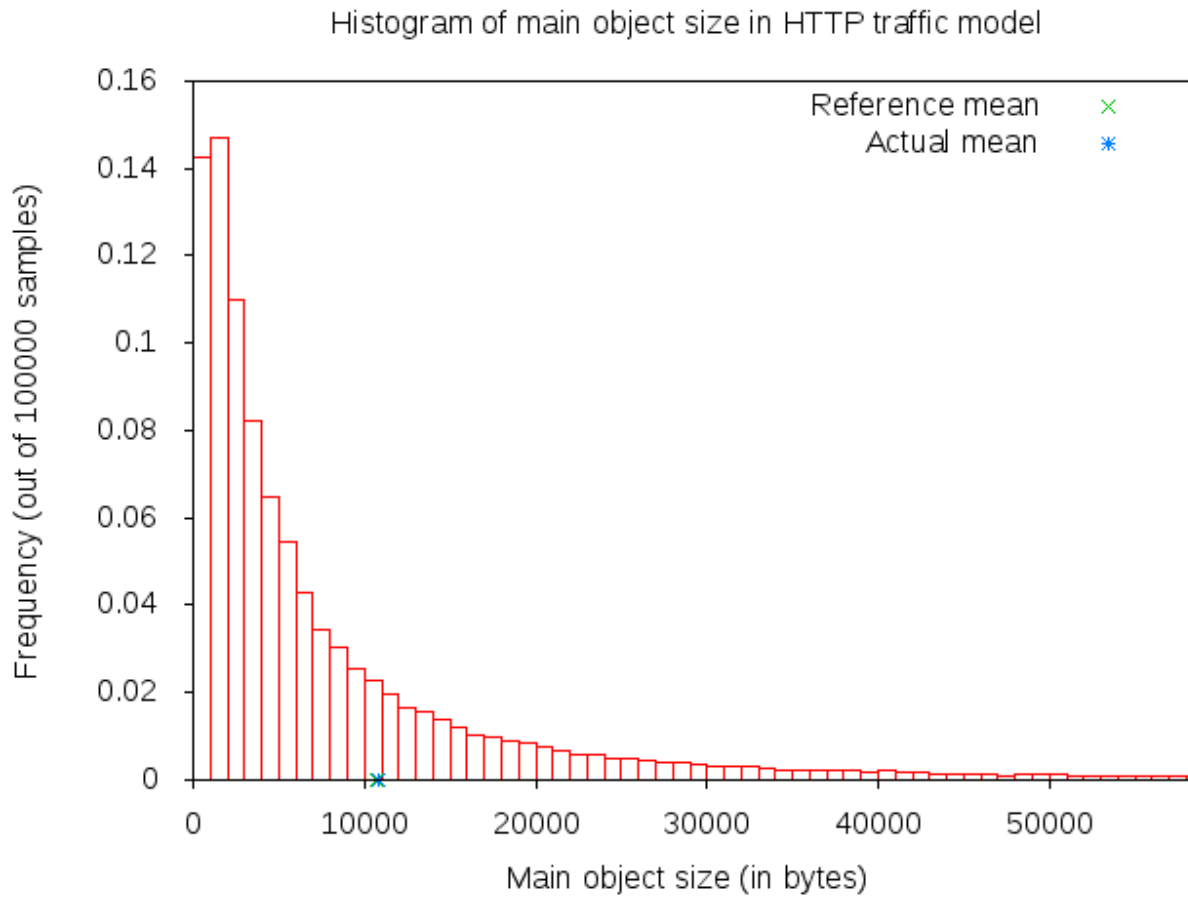

Fig. 1: 3GPP HTTP main object size histogram



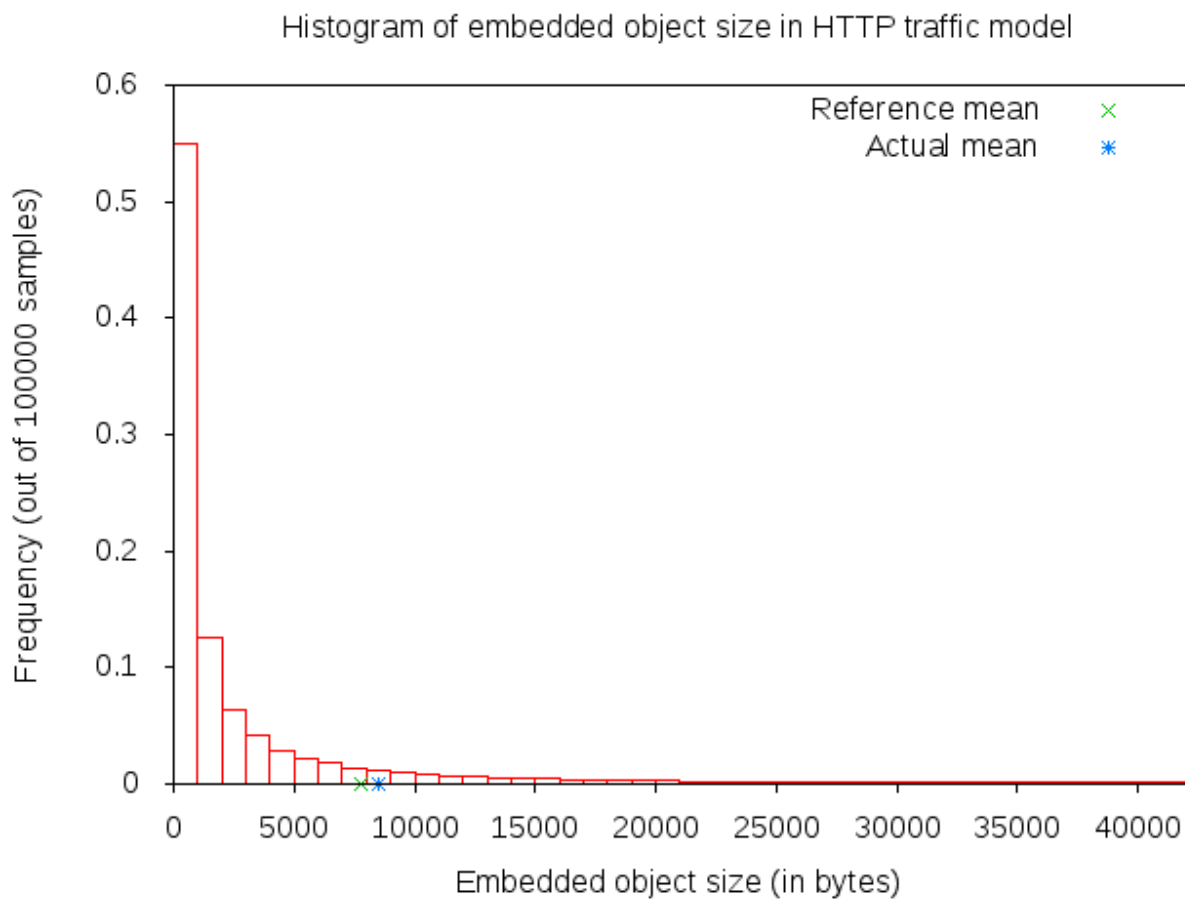

Fig. 2: 3GPP HTTP embedded object size histogram

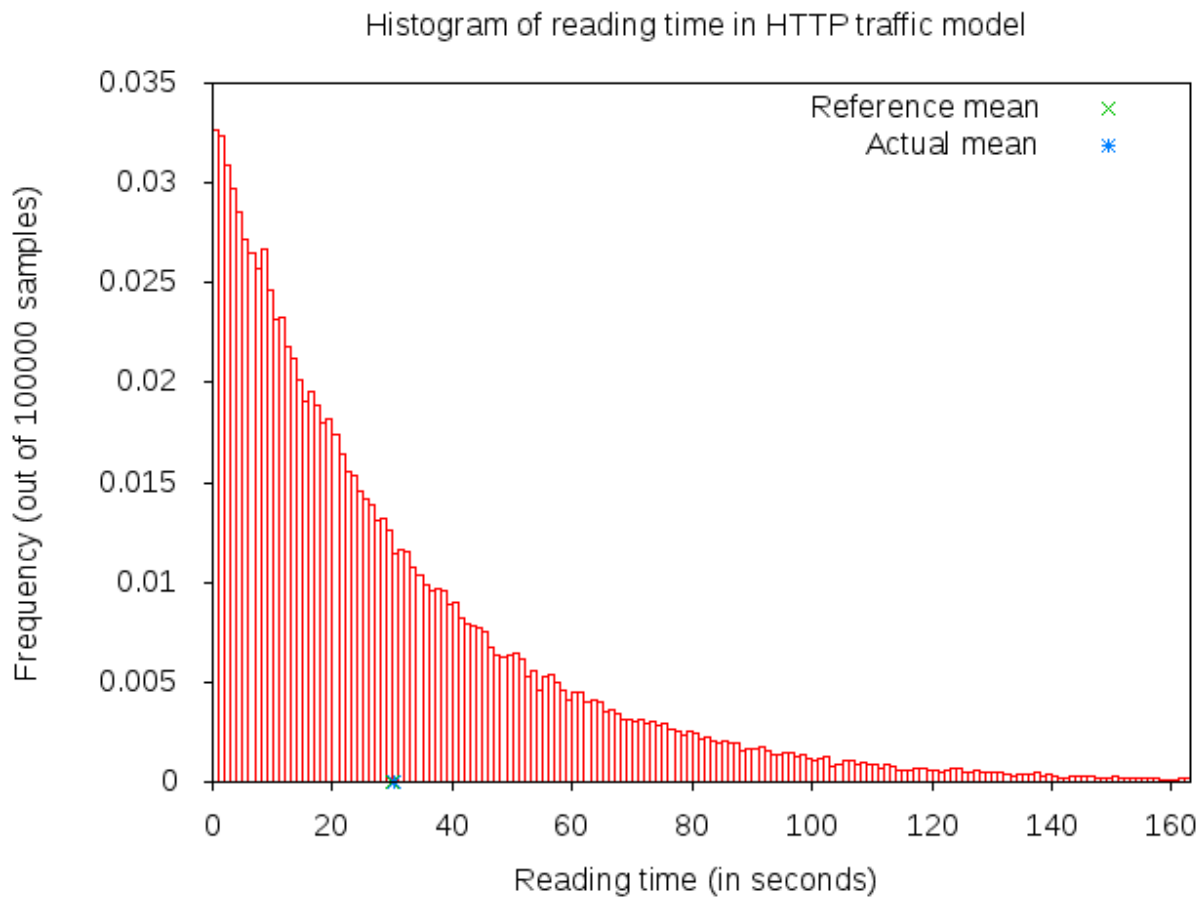

Fig. 3: 3GPP HTTP reading time histogram

Maximum transmission unit (MTU) size is configurable in `ThreeGppHttpServer` or in `ThreeGppHttpVariables`. By default, the low variant is 536 bytes and high variant is 1460 bytes. The default values are set with the intention of having a TCP header (size of which is 40 bytes) added in the packet in such way that lower layers can avoid splitting packets. The change of MTU sizes affects all TCP sockets after the server application has started. It is mainly visible in sizes of packets received by `ThreeGppHttpClient` applications.

### 3GPP HTTP client description

3GPP HTTP client is a model application which simulates the traffic of a web browser. This application works in conjunction with an `ThreeGppHttpServer` application.

In summary, the application works as follows.

1. Upon start, it opens a connection to the destination web server (`ThreeGppHttpServer`).
2. After the connection is established, the application immediately requests a *main object* from the server by sending a request packet.
3. After receiving a main object (which can take some time if it consists of several packets), the application “parses” the main object. Parsing time is illustrated in figure *3GPP HTTP parsing time histogram*.
4. The parsing takes a short time (randomly determined) to determine the number of *embedded objects* (also randomly determined) in the web page. Number of embedded object is illustrated in *3GPP HTTP number of embedded objects histogram*.
  - **If at least one embedded object is determined, the application requests** the first embedded object from the server. The request for the next embedded object follows after the previous embedded object has been completely received.
  - **If there is no more embedded object to request, the application enters** the *reading time*.
5. Reading time is a long delay (again, randomly determined) where the application does not induce any network traffic, thus simulating the user reading the downloaded web page.
6. After the reading time is finished, the process repeats to step #2.

The client models HTTP *persistent connection*, i.e., HTTP 1.1, where the connection to the server is maintained and used for transmitting and receiving all objects.

Each request by default has a constant size of 350 bytes. A `ThreeGppHttpHeader` is attached to each request packet. The header contains information such as the content type requested (either main object or embedded object) and the timestamp when the packet is transmitted (which will be used to compute the delay and RTT of the packet).

### 5.1.2 References

Many aspects of the traffic are randomly determined by `ThreeGppHttpVariables`. A separate instance of this object is used by the HTTP server and client applications. These characteristics are based on a legacy 3GPP specification. The description can be found in the following references:

- [1] 3GPP TR 25.892, “Feasibility Study for Orthogonal Frequency Division Multiplexing (OFDM) for UTRAN enhancement”
- [2] IEEE 802.16m, “Evaluation Methodology Document (EMD)”, IEEE 802.16m-08/004r5, July 2008.
- [3] NGMN Alliance, “NGMN Radio Access Performance Evaluation Methodology”, v1.0, January 2008.
- [4] 3GPP2-TSGC5, “HTTP, FTP and TCP models for 1xEV-DV simulations”, 2001.

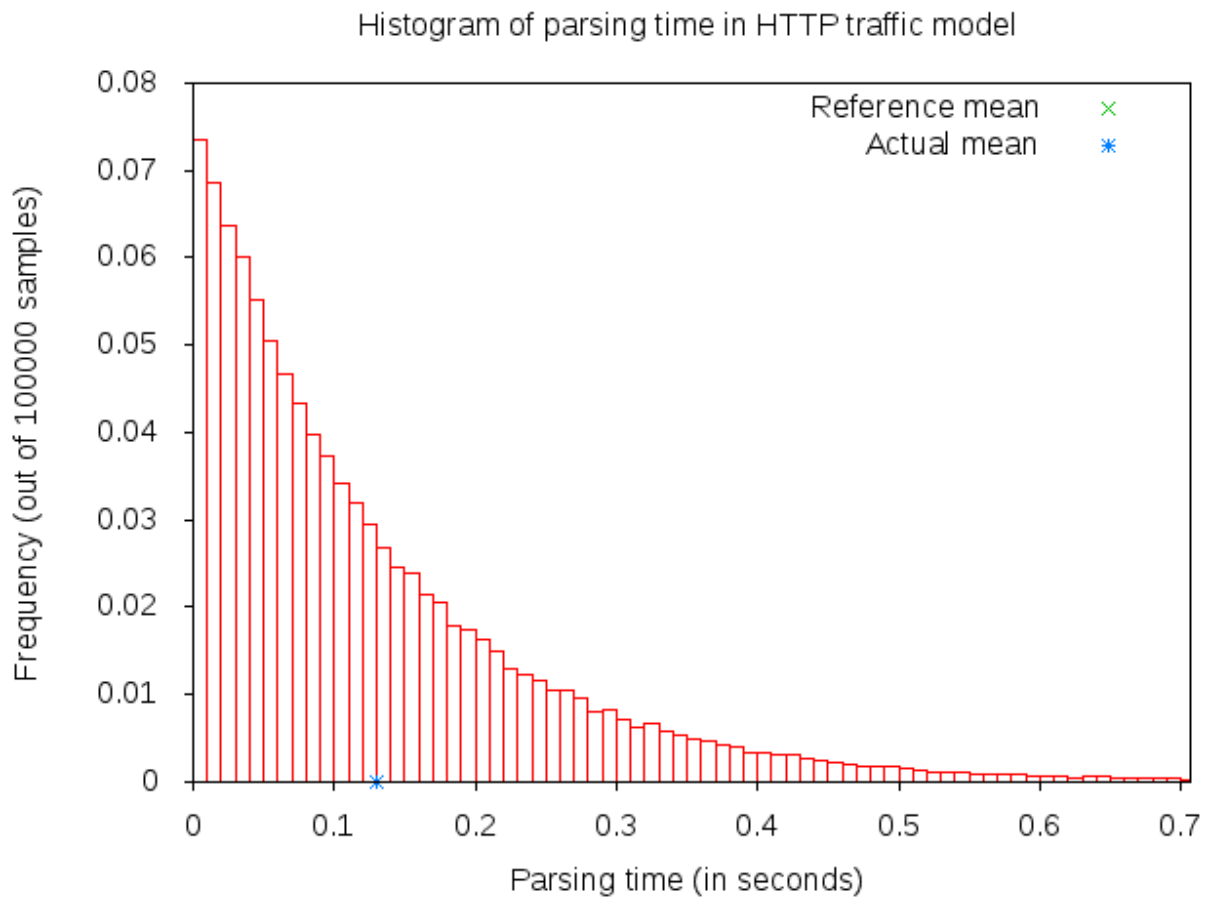

Fig. 4: 3GPP HTTP parsing time histogram

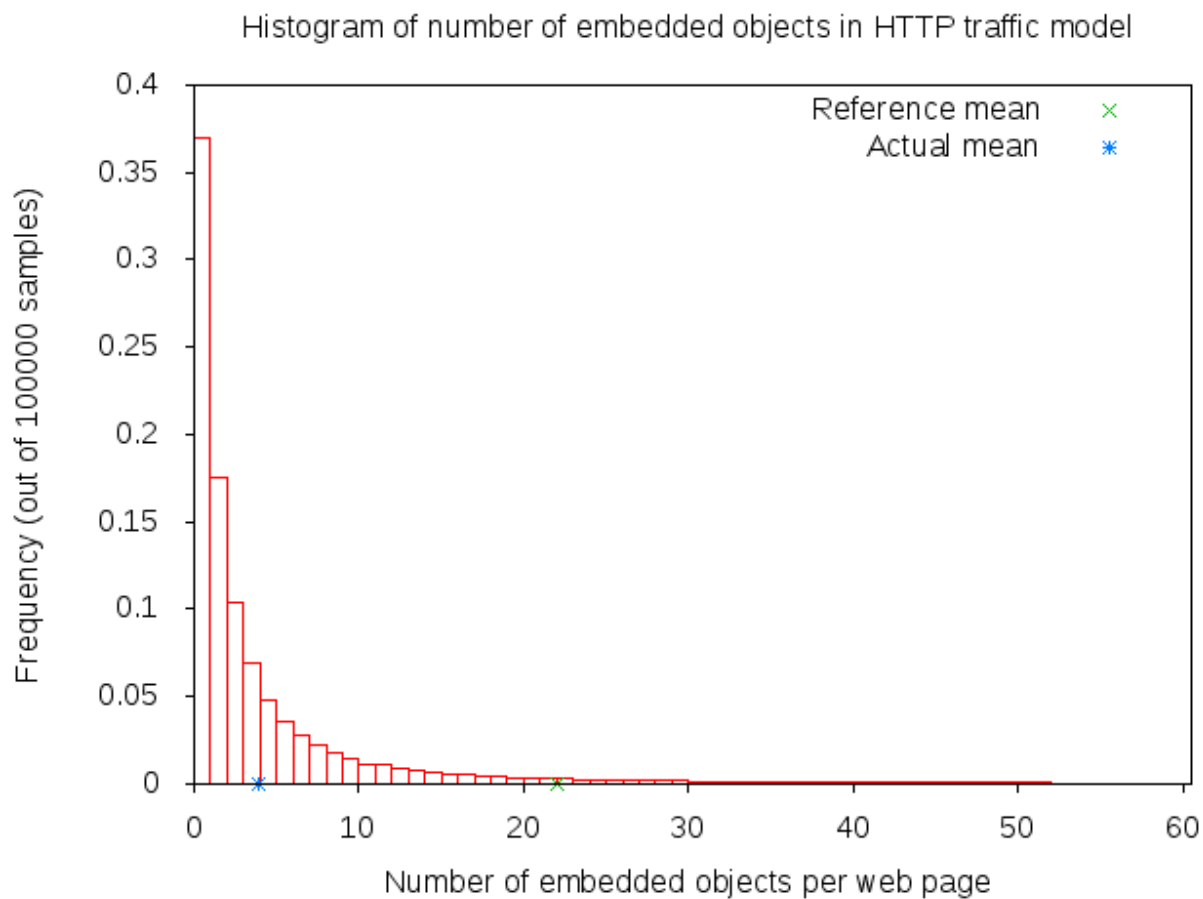

Fig. 5: 3GPP HTTP number of embedded objects histogram

## 5.2 Usage

The `three-gpp-http-example` can be referenced to see basic usage of the HTTP applications. In summary, using the `ThreeGppHttpServerHelper` and `ThreeGppHttpClientHelper` allow the user to easily install `ThreeGppHttpServer` and `ThreeGppHttpClient` applications to nodes. The helper objects can be used to configure attribute values for the client and server objects, but not for the `ThreeGppHttpVariables` object. Configuration of variables is done by modifying attributes of `ThreeGppHttpVariables`, which should be done prior to helpers installing applications to nodes.

The client and server provide a number of ns-3 trace sources such as “Tx”, “Rx”, “RxDelay”, and “StateTransition” on the server side, and a large number on the client side (“ConnectionEstablished”, “ConnectionClosed”, “TxMainObjectRequest”, “TxEmbeddedObjectRequest”, “RxMainObjectPacket”, “RxMainObject”, “RxEmbeddedObjectPacket”, “RxEmbeddedObject”, “Rx”, “RxDelay”, “RxRtt”, “StateTransition”).

### 5.2.1 Building the 3GPP HTTP applications

Building the applications does not require any special steps to be taken. It suffices to enable the applications module.

### 5.2.2 Examples

For an example demonstrating HTTP applications run:

```
$ ./waf --run 'three-gpp-http-example'
```

By default, the example will print out the web page requests of the client and responses of the server and client receiving content packets by using `LOG_INFO` of `ThreeGppHttpServer` and `ThreeGppHttpClient`.

### 5.2.3 Tests

For testing HTTP applications, `three-gpp-http-client-server-test` is provided. Run:

```
$ ./test.py -s three-gpp-http-client-server-test
```

The test consists of simple Internet nodes having HTTP server and client applications installed. Multiple variant scenarios are tested: delay is 3ms, 30ms or 300ms, bit error rate 0 or  $5.0 \cdot 10^{-6}$ , MTU size 536 or 1460 bytes and either IPV4 or IPV6 is used. A simulation with each combination of these parameters is run multiple times to verify functionality with different random variables.

Test cases themselves are rather simple: test verifies that HTTP object packet bytes sent match total bytes received by the client, and that `ThreeGppHttpHeader` matches the expected packet.

## BRIDGE NETDEVICE

*Placeholder chapter*

Some examples of the use of Bridge NetDevice can be found in `examples/csma/` directory.





## BRITE INTEGRATION

This model implements an interface to BRITE, the Boston university Representative Internet Topology generator<sup>1</sup>. BRITE is a standard tool for generating realistic internet topologies. The ns-3 model, described herein, provides a helper class to facilitate generating ns-3 specific topologies using BRITE configuration files. BRITE builds the original graph which is stored as nodes and edges in the ns-3 BriteTopologyHelper class. In the ns-3 integration of BRITE, the generator generates a topology and then provides access to leaf nodes for each AS generated. ns-3 users can then attach custom topologies to these leaf nodes either by creating them manually or using topology generators provided in ns-3.

There are three major types of topologies available in BRITE: Router, AS, and Hierarchical which is a combination of AS and Router. For the purposes of ns-3 simulation, the most useful are likely to be Router and Hierarchical. Router level topologies be generated using either the Waxman model or the Barabasi-Albert model. Each model has different parameters that effect topology creation. For flat router topologies, all nodes are considered to be in the same AS.

BRITE Hierarchical topologies contain two levels. The first is the AS level. This level can be also be created by using either the Waxman model or the Barabasi-Albert model. Then for each node in the AS topology, a router level topology is constructed. These router level topologies can again either use the Waxman model or the Barabasi-Albert model. BRITE interconnects these separate router topologies as specified by the AS level topology. Once the hierarchical topology is constructed, it is flattened into a large router level topology.

Further information can be found in the BRITE user manual: <http://www.cs.bu.edu/brite/publications/usermanual.pdf>

### 7.1 Model Description

The model relies on building an external BRITE library, and then building some ns-3 helpers that call out to the library. The source code for the ns-3 helpers lives in the directory `src/brite/helper`.

#### 7.1.1 Design

To generate the BRITE topology, ns-3 helpers call out to the external BRITE library, and using a standard BRITE configuration file, the BRITE code builds a graph with nodes and edges according to this configuration file. Please see the BRITE documentation or the example configuration files in `src/brite/examples/conf_files` to get a better grasp of BRITE configuration options. The graph built by BRITE is returned to ns-3, and a ns-3 implementation of the graph is built. Leaf nodes for each AS are available for the user to either attach custom topologies or install ns-3 applications directly.

---

<sup>1</sup> Alberto Medina, Anukool Lakhina, Ibrahim Matta, and John Byers. BRITE: An Approach to Universal Topology Generation. In Proceedings of the International Workshop on Modeling, Analysis and Simulation of Computer and Telecommunications Systems- MASCOTS '01, Cincinnati, Ohio, August 2001.

## 7.1.2 References

## 7.2 Usage

The brite-generic-example can be referenced to see basic usage of the BRITE interface. In summary, the BriteTopologyHelper is used as the interface point by passing in a BRITE configuration file. Along with the configuration file a BRITE formatted random seed file can also be passed in. If a seed file is not passed in, the helper will create a seed file using ns-3's UniformRandomVariable. Once the topology has been generated by BRITE, BuildBriteTopology() is called to create the ns-3 representation. Next IP Address can be assigned to the topology using either AssignIpv4Addresses() or AssignIpv6Addresses(). It should be noted that each point-to-point link in the topology will be treated as a new network therefore for IPV4 a /30 subnet should be used to avoid wasting a large amount of the available address space.

Example BRITE configuration files can be found in /src/brite/examples/conf\_files/. ASBarabasi and ASWaxman are examples of AS only topologies. The RTBarabasi and RTWaxman files are examples of router only topologies. Finally the TD\_ASBarabasi\_RTWaxman configuration file is an example of a Hierarchical topology that uses the Barabasi-Albert model for the AS level and the Waxman model for each of the router level topologies. Information on the BRITE parameters used in these files can be found in the BRITE user manual.

### 7.2.1 Building BRITE Integration

The first step is to download and build the ns-3 specific BRITE repository:

```
$ hg clone http://code.nsnam.org/BRITE
$ cd BRITE
$ make
```

This will build BRITE and create a library, libbrite.so, within the BRITE directory.

Once BRITE has been built successfully, we proceed to configure ns-3 with BRITE support. Change to your ns-3 directory:

```
$ ./waf configure --with-brite=/your/path/to/brite/source --enable-examples
```

Make sure it says 'enabled' beside 'BRITE Integration'. If it does not, then something has gone wrong. Either you have forgotten to build BRITE first following the steps above, or ns-3 could not find your BRITE directory.

Next, build ns-3:

```
$ ./waf
```

### 7.2.2 Examples

For an example demonstrating BRITE integration run:

```
$ ./waf --run 'brite-generic-example'
```

By enabling the verbose parameter, the example will print out the node and edge information in a similar format to standard BRITE output. There are many other command-line parameters including confFile, tracing, and nix, described below:

**confFile** A BRITE configuration file. Many different BRITE configuration file examples exist in the src/brite/examples/conf\_files directory, for example, RTBarabasi20.conf and RTWaxman.conf. Please refer to the conf\_files directory for more examples.

**tracing** Enables ascii tracing.

**nix** Enables nix-vector routing. Global routing is used by default.

The generic BRITE example also support visualization using pyviz, assuming python bindings in ns-3 are enabled:

```
$ ./waf --run brite-generic-example --vis
```

Simulations involving BRITE can also be used with MPI. The total number of MPI instances is passed to the BRITE topology helper where a modulo divide is used to assign the nodes for each AS to a MPI instance. An example can be found in src/brite/examples:

```
$ mpirun -np 2 ./waf --run brite-MPI-example
```

Please see the ns-3 MPI documentation for information on setting up MPI with ns-3.



## BUILDINGS MODULE

```
cd .. include:: replace.txt
```

### 8.1 Design documentation

#### 8.1.1 Overview

The Buildings module provides:

1. a new class (`Building`) that models the presence of a building in a simulation scenario;
2. a new class (`MobilityBuildingInfo`) that allows to specify the location, size and characteristics of buildings present in the simulated area, and allows the placement of nodes inside those buildings;
3. a container class with the definition of the most useful pathloss models and the correspondent variables called `BuildingsPropagationLossModel`.
4. a new propagation model (`HybridBuildingsPropagationLossModel`) working with the mobility model just introduced, that allows to model the phenomenon of indoor/outdoor propagation in the presence of buildings.
5. a simplified model working only with Okumura Hata (`OhBuildingsPropagationLossModel`) considering the phenomenon of indoor/outdoor propagation in the presence of buildings.
6. a channel condition model (`BuildingsChannelConditionModel`) which determined the LOS/NLOS channel condition based on the `Building` objects deployed in the scenario.
7. hybrid channel condition models (`ThreeGppV2vUrbanChannelConditionModel` and `ThreeGppV2vHighwayChannelConditionModel`) specifically designed to model vehicular environments (more information can be found in the *documentation of the propagation module*)

The models have been designed with LTE in mind, though their implementation is in fact independent from any LTE-specific code, and can be used with other ns-3 wireless technologies as well (e.g., wifi, wimax).

The `HybridBuildingsPropagationLossModel` pathloss model included is obtained through a combination of several well known pathloss models in order to mimic different environmental scenarios such as urban, suburban and open areas. Moreover, the model considers both outdoor and indoor indoor and outdoor communication has to be included since HeNB might be installed either within building and either outside. In case of indoor communication, the model has to consider also the type of building in outdoor <-> indoor communication according to some general criteria such as the wall penetration losses of the common materials; moreover it includes some general configuration for the internal walls in indoor communications.

The `OhBuildingsPropagationLossModel` pathloss model has been created for simplifying the previous one removing the thresholds for switching from one model to other. For doing this it has been used only one propagation

model from the one available (i.e., the Okumura Hata). The presence of building is still considered in the model; therefore all the considerations of above regarding the building type are still valid. The same consideration can be done for what concern the environmental scenario and frequency since both of them are parameters of the model considered.

### 8.1.2 The Building class

The model includes a specific class called `Building` which contains a ns3 `Box` class for defining the dimension of the building. In order to implements the characteristics of the pathloss models included, the `Building` class supports the following attributes:

- building type:
  - Residential (default value)
  - Office
  - Commercial
- external walls type
  - Wood
  - ConcreteWithWindows (default value)
  - ConcreteWithoutWindows
  - StoneBlocks
- number of floors (default value 1, which means only ground-floor)
- number of rooms in x-axis (default value 1)
- number of rooms in y-axis (default value 1)

The `Building` class is based on the following assumptions:

- a buildings is represented as a rectangular parallelepiped (i.e., a box)
- the walls are parallel to the x, y, and z axis
- a building is divided into a grid of rooms, identified by the following parameters:
  - number of floors
  - number of rooms along the x-axis
  - number of rooms along the y-axis
- the z axis is the vertical axis, i.e., floor numbers increase for increasing z axis values
- the x and y room indices start from 1 and increase along the x and y axis respectively
- all rooms in a building have equal size

### 8.1.3 The MobilityBuildingInfo class

The `MobilityBuildingInfo` class, which inherits from the ns3 class `Object`, is in charge of maintaining information about the position of a node with respect to building. The information managed by `MobilityBuildingInfo` is:

- whether the node is indoor or outdoor
- if indoor:
  - in which building the node is

- in which room the node is positioned (x, y and floor room indices)

The class `MobilityBuildingInfo` is used by `BuildingsPropagationLossModel` class, which inherits from the ns3 class `PropagationLossModel` and manages the pathloss computation of the single components and their composition according to the nodes' positions. Moreover, it implements also the shadowing, that is the loss due to obstacles in the main path (i.e., vegetation, buildings, etc.).

It is to be noted that, `MobilityBuildingInfo` can be used by any other propagation model. However, based on the information at the time of this writing, only the ones defined in the building module are designed for considering the constraints introduced by the buildings.

### 8.1.4 ItuR1238PropagationLossModel

This class implements a building-dependent indoor propagation loss model based on the ITU P.1238 model, which includes losses due to type of building (i.e., residential, office and commercial). The analytical expression is given in the following.

$$L_{total} = 20 \log f + N \log d + L_f(n) - 28[dB]$$

where:

$$N = \begin{cases} 28 & \text{residential} \\ 30 & \text{office} \\ 22 & \text{commercial} \end{cases} : \text{power loss coefficient [dB]}$$

$$L_f = \begin{cases} 4n & \text{residential} \\ 15 + 4(n - 1) & \text{office} \\ 6 + 3(n - 1) & \text{commercial} \end{cases}$$

$n$  : number of floors between base station and mobile ( $n \geq 1$ )

$f$  : frequency [MHz]

$d$  : distance (where  $d > 1$ ) [m]

### 8.1.5 BuildingsPropagationLossModel

The `BuildingsPropagationLossModel` provides an additional set of building-dependent pathloss model elements that are used to implement different pathloss logics. These pathloss model elements are described in the following subsections.

#### External Wall Loss (EWL)

This component models the penetration loss through walls for indoor to outdoor communications and vice-versa. The values are taken from the [cost231] model.

- Wood ~ 4 dB
- Concrete with windows (not metallized) ~ 7 dB
- Concrete without windows ~ 15 dB (spans between 10 and 20 in COST231)
- Stone blocks ~ 12 dB

## Internal Walls Loss (IWL)

This component models the penetration loss occurring in indoor-to-indoor communications within the same building. The total loss is calculated assuming that each single internal wall has a constant penetration loss  $L_{siw}$ , and approximating the number of walls that are penetrated with the manhattan distance (in number of rooms) between the transmitter and the receiver. In detail, let  $x_1, y_1, x_2, y_2$  denote the room number along the  $x$  and  $y$  axis respectively for user 1 and 2; the total loss  $L_{IWL}$  is calculated as

$$L_{IWL} = L_{siw}(|x_1 - x_2| + |y_1 - y_2|)$$

## Height Gain Model (HG)

This component model the gain due to the fact that the transmitting device is on a floor above the ground. In the literature [turkmani] this gain has been evaluated as about 2 dB per floor. This gain can be applied to all the indoor to outdoor communications and vice-versa.

## Shadowing Model

The shadowing is modeled according to a log-normal distribution with variable standard deviation as function of the relative position (indoor or outdoor) of the MobilityModel instances involved. One random value is drawn for each pair of MobilityModels, and stays constant for that pair during the whole simulation. Thus, the model is appropriate for static nodes only.

The model considers that the mean of the shadowing loss in dB is always 0. For the variance, the model considers three possible values of standard deviation, in detail:

- outdoor (`m_shadowingSigmaOutdoor`, default value of 7 dB)  $\rightarrow X_O \sim N(\mu_O, \sigma_O^2)$ .
- indoor (`m_shadowingSigmaIndoor`, default value of 10 dB)  $\rightarrow X_I \sim N(\mu_I, \sigma_I^2)$ .
- external walls penetration (`m_shadowingSigmaExtWalls`, default value 5 dB)  $\rightarrow X_W \sim N(\mu_W, \sigma_W^2)$

The simulator generates a shadowing value per each active link according to nodes' position the first time the link is used for transmitting. In case of transmissions from outdoor nodes to indoor ones, and vice-versa, the standard deviation ( $\sigma_{IO}$ ) has to be calculated as the square root of the sum of the quadratic values of the standard deviation in case of outdoor nodes and the one for the external walls penetration. This is due to the fact that the components producing the shadowing are independent of each other; therefore, the variance of a distribution resulting from the sum of two independent normal ones is the sum of the variances.

$$\begin{aligned} X &\sim N(\mu, \sigma^2) \text{ and } Y \sim N(\nu, \tau^2) \\ Z = X + Y &\sim Z(\mu + \nu, \sigma^2 + \tau^2) \\ \Rightarrow \sigma_{IO} &= \sqrt{\sigma_O^2 + \sigma_W^2} \end{aligned}$$

### 8.1.6 Pathloss logics

In the following we describe the different pathloss logic that are implemented by inheriting from `BuildingsPropagationLossModel`.

#### HybridBuildingsPropagationLossModel

The `HybridBuildingsPropagationLossModel` pathloss model included is obtained through a combination of several well known pathloss models in order to mimic different outdoor and indoor scenarios, as well as indoor-to-



outdoor and outdoor-to-indoor scenarios. In detail, the class `HybridBuildingsPropagationLossModel` integrates the following pathloss models:

- `OkumuraHataPropagationLossModel` (OH) (at frequencies > 2.3 GHz substituted by `Kun2600MhzPropagationLossModel`)
- `ItuR1411LosPropagationLossModel` and `ItuR1411NlosOverRooftopPropagationLossModel` (I1411)
- `ItuR1238PropagationLossModel` (I1238)
- the pathloss elements of the `BuildingsPropagationLossModel` (EWL, HG, IWL)

The following pseudo-code illustrates how the different pathloss model elements described above are integrated in `HybridBuildingsPropagationLossModel`:

```

if (txNode is outdoor)
  then
    if (rxNode is outdoor)
      then
        if (distance > 1 km)
          then
            if (rxNode or txNode is below the rooftop)
              then
                L = I1411
              else
                L = OH
            else
              L = I1411
          else (rxNode is indoor)
            if (distance > 1 km)
              then
                if (rxNode or txNode is below the rooftop)
                  L = I1411 + EWL + HG
                else
                  L = OH + EWL + HG
              else
                L = I1411 + EWL + HG
        else (txNode is indoor)
          if (rxNode is indoor)
            then
              if (same building)
                then
                  L = I1238 + IWL
              else
                L = I1411 + 2*EWL
          else (rxNode is outdoor)
            if (distance > 1 km)
              then
                if (rxNode or txNode is below the rooftop)
                  then
                    L = I1411 + EWL + HG
                  else
                    L = OH + EWL + HG
            else
              L = I1411 + EWL

```

We note that, for the case of communication between two nodes below rooftop level with distance is greater then 1 km, we still consider the I1411 model, since OH is specifically designed for macro cells and therefore for antennas above the roof-top level.

For the ITU-R P.1411 model we consider both the LOS and NLoS versions. In particular, we consider the LoS propagation for distances that are shorter than a tunable threshold (`m_itu1411NlosThreshold`). In case on NLoS propagation, the over the roof-top model is taken in consideration for modeling both macro BS and SC. In case on NLoS several parameters scenario dependent have been included, such as average street width, orientation, etc. The values of such parameters have to be properly set according to the scenario implemented, the model does not calculate natively their values. In case any values is provided, the standard ones are used, apart for the height of the mobile and BS, which instead their integrity is tested directly in the code (i.e., they have to be greater than zero). In the following we give the expressions of the components of the model.

We also note that the use of different propagation models (OH, I1411, I1238 with their variants) in `HybridBuildingsPropagationLossModel` can result in discontinuities of the pathloss with respect to distance. A proper tuning of the attributes (especially the distance threshold attributes) can avoid these discontinuities. However, since the behavior of each model depends on several other parameters (frequency, node height, etc), there is no default value of these thresholds that can avoid the discontinuities in all possible configurations. Hence, an appropriate tuning of these parameters is left to the user.

### OhBuildingsPropagationLossModel

The `OhBuildingsPropagationLossModel` class has been created as a simple means to solve the discontinuity problems of `HybridBuildingsPropagationLossModel` without doing scenario-specific parameter tuning. The solution is to use only one propagation loss model (i.e., Okumura Hata), while retaining the structure of the pathloss logic for the calculation of other path loss components (such as wall penetration losses). The result is a model that is free of discontinuities (except those due to walls), but that is less realistic overall for a generic scenario with buildings and outdoor/indoor users, e.g., because Okumura Hata is not suitable neither for indoor communications nor for outdoor communications below rooftop level.

In detail, the class `OhBuildingsPropagationLossModel` integrates the following pathloss models:

- `OkumuraHataPropagationLossModel` (OH)
- the pathloss elements of the `BuildingsPropagationLossModel` (EWL, HG, IWL)

The following pseudo-code illustrates how the different pathloss model elements described above are integrated in `OhBuildingsPropagationLossModel`:

```
if (txNode is outdoor)
  then
    if (rxNode is outdoor)
      then
        L = OH
      else (rxNode is indoor)
        L = OH + EWL
  else (txNode is indoor)
    if (rxNode is indoor)
      then
        if (same building)
          then
            L = OH + IWL
          else
            L = OH + 2*EWL
      else (rxNode is outdoor)
        L = OH + EWL
```

We note that `OhBuildingsPropagationLossModel` is a significant simplification with respect to `HybridBuildingsPropagationLossModel`, due to the fact that OH is used always. While this gives a less accurate model in some scenarios (especially below rooftop and indoor), it effectively avoids the issue of pathloss discontinuities that affects `HybridBuildingsPropagationLossModel`.

## 8.2 User Documentation

### 8.2.1 How to use buildings in a simulation

In this section we explain the basic usage of the buildings model within a simulation program.

#### Include the headers

Add this at the beginning of your simulation program:

```
#include <ns3/buildings-module.h>
```

#### Create a building

As an example, let's create a residential 10 x 20 x 10 building:

```
double x_min = 0.0;
double x_max = 10.0;
double y_min = 0.0;
double y_max = 20.0;
double z_min = 0.0;
double z_max = 10.0;
Ptr<Building> b = CreateObject <Building> ();
b->SetBoundaries (Box (x_min, x_max, y_min, y_max, z_min, z_max));
b->SetBuildingType (Building::Residential);
b->SetExtWallsType (Building::ConcreteWithWindows);
b->SetNFloors (3);
b->SetNRoomsX (3);
b->SetNRoomsY (2);
```

This building has three floors and an internal 3 x 2 grid of rooms of equal size.

The helper class `GridBuildingAllocator` is also available to easily create a set of buildings with identical characteristics placed on a rectangular grid. Here's an example of how to use it:

```
Ptr<GridBuildingAllocator> gridBuildingAllocator;
gridBuildingAllocator = CreateObject<GridBuildingAllocator> ();
gridBuildingAllocator->SetAttribute ("GridWidth", UintegerValue (3));
gridBuildingAllocator->SetAttribute ("LengthX", DoubleValue (7));
gridBuildingAllocator->SetAttribute ("LengthY", DoubleValue (13));
gridBuildingAllocator->SetAttribute ("DeltaX", DoubleValue (3));
gridBuildingAllocator->SetAttribute ("DeltaY", DoubleValue (3));
gridBuildingAllocator->SetAttribute ("Height", DoubleValue (6));
gridBuildingAllocator->SetBuildingAttribute ("NRoomsX", UintegerValue (2));
gridBuildingAllocator->SetBuildingAttribute ("NRoomsY", UintegerValue (4));
gridBuildingAllocator->SetBuildingAttribute ("NFloors", UintegerValue (2));
gridBuildingAllocator->SetAttribute ("MinX", DoubleValue (0));
gridBuildingAllocator->SetAttribute ("MinY", DoubleValue (0));
gridBuildingAllocator->Create (6);
```

This will create a 3x2 grid of 6 buildings, each 7 x 13 x 6 m with 2 x 4 rooms inside and 2 floors; the buildings are spaced by 3 m on both the x and the y axis.

## Setup nodes and mobility models

Nodes and mobility models are configured as usual, however in order to use them with the buildings model you need an additional call to `BuildingsHelper::Install()`, so as to let the mobility model include the information on their position w.r.t. the buildings. Here is an example:

```
MobilityHelper mobility;
mobility.SetMobilityModel ("ns3::ConstantPositionMobilityModel");
ueNodes.Create (2);
mobility.Install (ueNodes);
BuildingsHelper::Install (ueNodes);
```

It is to be noted that any mobility model can be used. However, the user is advised to make sure that the behavior of the mobility model being used is consistent with the presence of Buildings. For example, using a simple random mobility over the whole simulation area in presence of buildings might easily results in node moving in and out of buildings, regardless of the presence of walls.

## Place some nodes

You can place nodes in your simulation using several methods, which are described in the following.

### Legacy positioning methods

Any legacy ns-3 positioning method can be used to place node in the simulation. The important additional step is to For example, you can place nodes manually like this:

```
Ptr<ConstantPositionMobilityModel> mm0 = enbNodes.Get (0)->GetObject
↳<ConstantPositionMobilityModel> ();
Ptr<ConstantPositionMobilityModel> mm1 = enbNodes.Get (1)->GetObject
↳<ConstantPositionMobilityModel> ();
mm0->SetPosition (Vector (5.0, 5.0, 1.5));
mm1->SetPosition (Vector (30.0, 40.0, 1.5));

MobilityHelper mobility;
mobility.SetMobilityModel ("ns3::ConstantPositionMobilityModel");
ueNodes.Create (2);
mobility.Install (ueNodes);
BuildingsHelper::Install (ueNodes);
mm0->SetPosition (Vector (5.0, 5.0, 1.5));
mm1->SetPosition (Vector (30.0, 40.0, 1.5));
```

Alternatively, you could use any existing `PositionAllocator` class. The coordinates of the node will determine whether it is placed outdoor or indoor and, if indoor, in which building and room it is placed.

### Building-specific positioning methods

The following position allocator classes are available to place node in special positions with respect to buildings:

- `RandomBuildingPositionAllocator`: Allocate each position by randomly choosing a building from the list of all buildings, and then randomly choosing a position inside the building.
- `RandomRoomPositionAllocator`: Allocate each position by randomly choosing a room from the list of rooms in all buildings, and then randomly choosing a position inside the room.

- `SameRoomPositionAllocator`: Walks a given `NodeContainer` sequentially, and for each node allocate a new position randomly in the same room of that node.
- `FixedRoomPositionAllocator`: Generate a random position uniformly distributed in the volume of a chosen room inside a chosen building.

### Making the Mobility Model Consistent for a node

Initially, a mobility model of a node is made consistent when a node is initialized, which eventually triggers a call to the `DoInitialize` method of the `MobilityBuildingInfo` class. In particular, it calls the `MakeMobilityModelConsistent` method, which goes through the lists of all buildings, determine if the node is indoor or outdoor, and if indoor it also determines the building in which the node is located and the corresponding floor number inside the building. Moreover, this method also caches the position of the node, which is used to make the mobility model consistent for a moving node whenever the `IsInside` method of `MobilityBuildingInfo` class is called.

### Building-aware pathloss model

After you placed buildings and nodes in a simulation, you can use a building-aware pathloss model in a simulation exactly in the same way you would use any regular path loss model. How to do this is specific for the wireless module that you are considering (lte, wifi, wimax, etc.), so please refer to the documentation of that model for specific instructions.

### Building-aware channel condition models

The class `BuildingsChannelConditionModel` implements a [channel condition model](#) which determines the LOS/NLOS channel state based on the buildings deployed in the scenario.

The classes `ThreeGppV2vUrbanChannelConditionModel` and `ThreeGppV2vHighwayChannelConditionModel` implement hybrid channel condition models, specifically designed to model vehicular environments. More information can be found in the [documentation of the propagation module](#).

## 8.2.2 Main configurable attributes

The `Building` class has the following configurable parameters:

- building type: Residential, Office and Commercial.
- external walls type: Wood, ConcreteWithWindows, ConcreteWithoutWindows and StoneBlocks.
- building bounds: a `Box` class with the building bounds.
- number of floors.
- number of rooms in x-axis and y-axis (rooms can be placed only in a grid way).

The `BuildingMobilityLossModel` parameter configurable with the ns3 attribute system is represented by the bound (string `Bounds`) of the simulation area by providing a `Box` class with the area bounds. Moreover, by means of its methods the following parameters can be configured:

- the number of floor the node is placed (default 0).
- the position in the rooms grid.

The `BuildingPropagationLossModel` class has the following configurable parameters configurable with the attribute system:

- **Frequency:** reference frequency (default 2160 MHz), note that by setting the frequency the wavelength is set accordingly automatically and viceversa).
- **Lambda:** the wavelength (0.139 meters, considering the above frequency).
- **ShadowSigmaOutdoor:** the standard deviation of the shadowing for outdoor nodes (default 7.0).
- **ShadowSigmaIndoor:** the standard deviation of the shadowing for indoor nodes (default 8.0).
- **ShadowSigmaExtWalls:** the standard deviation of the shadowing due to external walls penetration for outdoor to indoor communications (default 5.0).
- **RoofTopLevel:** the level of the rooftop of the building in meters (default 20 meters).
- **Los2NlosThr:** the value of distance of the switching point between line-of-sight and non-line-of-sight propagation model in meters (default 200 meters).
- **ITU1411DistanceThr:** the value of distance of the switching point between short range (ITU 1211) communications and long range (Okumura Hata) in meters (default 200 meters).
- **MinDistance:** the minimum distance in meters between two nodes for evaluating the pathloss (considered neglectible before this threshold) (default 0.5 meters).
- **Environment:** the environment scenario among Urban, SubUrban and OpenAreas (default Urban).
- **CitySize:** the dimension of the city among Small, Medium, Large (default Large).

In order to use the hybrid mode, the class to be used is the `HybridBuildingMobilityLossModel`, which allows the selection of the proper pathloss model according to the pathloss logic presented in the design chapter. However, this solution has the problem that the pathloss model switching points might present discontinuities due to the different characteristics of the model. This implies that according to the specific scenario, the threshold used for switching have to be properly tuned. The simple `OhBuildingMobilityLossModel` overcome this problem by using only the Okumura Hata model and the wall penetration losses.

## 8.3 Testing Documentation

### 8.3.1 Overview

To test and validate the ns-3 Building Pathloss module, some test suites is provided which are integrated with the ns-3 test framework. To run them, you need to have configured the build of the simulator in this way:

```
$ ./waf configure --enable-tests --enable-modules=buildings
$ ./test.py
```

The above will run not only the test suites belonging to the buildings module, but also those belonging to all the other ns-3 modules on which the buildings module depends. See the ns-3 manual for generic information on the testing framework.

You can get a more detailed report in HTML format in this way:

```
$ ./test.py -w results.html
```

After the above command has run, you can view the detailed result for each test by opening the file `results.html` with a web browser.

You can run each test suite separately using this command:

```
$ ./test.py -s test-suite-name
```

For more details about `test.py` and the ns-3 testing framework, please refer to the ns-3 manual.

## 8.3.2 Description of the test suites

### BuildingsHelper test

The test suite `buildings-helper` checks that the method `BuildingsHelper::MakeAllInstancesConsistent()` works properly, i.e., that the `BuildingsHelper` is successful in locating if nodes are outdoor or indoor, and if indoor that they are located in the correct building, room and floor. Several test cases are provided with different buildings (having different size, position, rooms and floors) and different node positions. The test passes if each every node is located correctly.

### BuildingPositionAllocator test

The test suite `building-position-allocator` feature two test cases that check that respectively `RandomRoomPositionAllocator` and `SameRoomPositionAllocator` work properly. Each test cases involves a single 2x3x2 room building (total 12 rooms) at known coordinates and respectively 24 and 48 nodes. Both tests check that the number of nodes allocated in each room is the expected one and that the position of the nodes is also correct.

### Buildings Pathloss tests

The test suite `buildings-pathloss-model` provides different unit tests that compare the expected results of the buildings pathloss module in specific scenarios with pre calculated values obtained offline with an Octave script (`test/reference/buildings-pathloss.m`). The tests are considered passed if the two values are equal up to a tolerance of 0.1, which is deemed appropriate for the typical usage of pathloss values (which are in dB).

In the following we detailed the scenarios considered, their selection has been done for covering the wide set of possible pathloss logic combinations. The pathloss logic results therefore implicitly tested.

#### Test #1 Okumura Hata

In this test we test the standard Okumura Hata model; therefore both eNB and UE are placed outside at a distance of 2000 m. The frequency used is the E-UTRA band #5, which correspond to 869 MHz (see table 5.5-1 of 36.101). The test includes also the validation of the areas extensions (i.e., urban, suburban and open-areas) and of the city size (small, medium and large).

#### Test #2 COST231 Model

This test is aimed at validating the COST231 model. The test is similar to the Okumura Hata one, except that the frequency used is the EUTRA band #1 (2140 MHz) and that the test can be performed only for large and small cities in urban scenarios due to model limitations.

#### Test #3 2.6 GHz model

This test validates the 2.6 GHz Kun model. The test is similar to Okumura Hata one except that the frequency is the EUTRA band #7 (2620 MHz) and the test can be performed only in urban scenario.

#### **Test #4 ITU1411 LoS model**

This test is aimed at validating the ITU1411 model in case of line of sight within street canyons transmissions. In this case the UE is placed at 100 meters far from the eNB, since the threshold for switching between LoS and NLoS is left to default one (i.e., 200 m.).

#### **Test #5 ITU1411 NLoS model**

This test is aimed at validating the ITU1411 model in case of non line of sight over the rooftop transmissions. In this case the UE is placed at 900 meters far from the eNB, in order to be above the threshold for switching between LoS and NLoS is left to default one (i.e., 200 m.).

#### **Test #6 ITUP1238 model**

This test is aimed at validating the ITUP1238 model in case of indoor transmissions. In this case both the UE and the eNB are placed in a residential building with walls made of concrete with windows. Ue is placed at the second floor and distances 30 meters far from the eNB, which is placed at the first floor.

#### **Test #7 Outdoor -> Indoor with Okumura Hata model**

This test validates the outdoor to indoor transmissions for large distances. In this case the UE is placed in a residential building with wall made of concrete with windows and distances 2000 meters from the outdoor eNB.

#### **Test #8 Outdoor -> Indoor with ITU1411 model**

This test validates the outdoor to indoor transmissions for short distances. In this case the UE is placed in a residential building with walls made of concrete with windows and distances 100 meters from the outdoor eNB.

#### **Test #9 Indoor -> Outdoor with ITU1411 model**

This test validates the outdoor to indoor transmissions for very short distances. In this case the eNB is placed in the second floor of a residential building with walls made of concrete with windows and distances 100 meters from the outdoor UE (i.e., LoS communication). Therefore the height gain has to be included in the pathloss evaluation.

#### **Test #10 Indoor -> Outdoor with ITU1411 model**

This test validates the outdoor to indoor transmissions for short distances. In this case the eNB is placed in the second floor of a residential building with walls made of concrete with windows and distances 500 meters from the outdoor UE (i.e., NLoS communication). Therefore the height gain has to be included in the pathloss evaluation.

#### **Buildings Shadowing Test**

The test suite `buildings-shadowing-test` is a unit test intended to verify the statistical distribution of the shadowing model implemented by `BuildingsPathlossModel`. The shadowing is modeled according to a normal



distribution with mean  $\mu = 0$  and variable standard deviation  $\sigma$ , according to models commonly used in literature. Three test cases are provided, which cover the cases of indoor, outdoor and indoor-to-outdoor communications. Each test case generates 1000 different samples of shadowing for different pairs of `MobilityModel` instances in a given scenario. Shadowing values are obtained by subtracting from the total loss value returned by `HybridBuildingsPathlossModel` the path loss component which is constant and pre-determined for each test case. The test verifies that the sample mean and sample variance of the shadowing values fall within the 99% confidence interval of the sample mean and sample variance. The test also verifies that the shadowing values returned at successive times for the same pair of `MobilityModel` instances is constant.

### **Buildings Channel Condition Model Test**

The `BuildingsChannelConditionModelTestSuite` tests the class `BuildingsChannelConditionModel`. It checks if the channel condition between two nodes is correctly determined when a building is deployed.

## **8.4 References**



## CLICK MODULAR ROUTER INTEGRATION

Click is a software architecture for building configurable routers. By using different combinations of packet processing units called elements, a Click router can be made to perform a specific kind of functionality. This flexibility provides a good platform for testing and experimenting with different protocols.

### 9.1 Model Description

The source code for the Click model lives in the directory `src/click`.

#### 9.1.1 Design

ns-3's design is well suited for an integration with Click due to the following reasons:

- Packets in ns-3 are serialised/deserialised as they move up/down the stack. This allows ns-3 packets to be passed to and from Click as they are.
- This also means that any kind of ns-3 traffic generator and transport should work easily on top of Click.
- By striving to implement click as an `Ipv4RoutingProtocol` instance, we can avoid significant changes to the LL and MAC layer of the ns-3 code.

The design goal was to make the ns-3-click public API simple enough such that the user needs to merely add an `Ipv4ClickRouting` instance to the node, and inform each Click node of the Click configuration file (.click file) that it is to use.

This model implements the interface to the Click Modular Router and provides the `Ipv4ClickRouting` class to allow a node to use Click for external routing. Unlike normal `Ipv4RoutingProtocol` sub types, `Ipv4ClickRouting` doesn't use a `RouteInput()` method, but instead, receives a packet on the appropriate interface and processes it accordingly. Note that you need to have a routing table type element in your Click graph to use Click for external routing. This is needed by the `RouteOutput()` function inherited from `Ipv4RoutingProtocol`. Furthermore, a Click based node uses a different kind of L3 in the form of `Ipv4L3ClickProtocol`, which is a trimmed down version of `Ipv4L3Protocol`. `Ipv4L3ClickProtocol` passes on packets passing through the stack to `Ipv4ClickRouting` for processing.

#### Developing a Simulator API to allow ns-3 to interact with Click

Much of the API is already well defined, which allows Click to probe for information from the simulator (like a Node's ID, an Interface ID and so forth). By retaining most of the methods, it should be possible to write new implementations specific to ns-3 for the same functionality.

Hence, for the Click integration with ns-3, a class named `Ipv4ClickRouting` will handle the interaction with Click. The code for the same can be found in `src/click/model/ipv4-click-routing.{cc,h}`.

## Packet hand off between ns-3 and Click

There are four kinds of packet hand-offs that can occur between ns-3 and Click.

- L4 to L3
- L3 to L4
- L3 to L2
- L2 to L3

To overcome this, we implement `Ipv4L3ClickProtocol`, a stripped down version of `Ipv4L3Protocol`. `Ipv4L3ClickProtocol` passes packets to and from `Ipv4ClickRouting` appropriately to perform routing.

### 9.1.2 Scope and Limitations

- In its current state, the NS-3 Click Integration is limited to use only with L3, leaving NS-3 to handle L2. We are currently working on adding Click MAC support as well. See the usage section to make sure that you design your Click graphs accordingly.
- Furthermore, ns-3-click will work only with userlevel elements. The complete list of elements are available at <http://read.cs.ucla.edu/click/elements>. Elements that have 'all', 'userlevel' or 'ns' mentioned beside them may be used.
- As of now, the ns-3 interface to Click is Ipv4 only. We will be adding Ipv6 support in the future.

### 9.1.3 References

- Eddie Kohler, Robert Morris, Benjie Chen, John Jannotti, and M. Frans Kaashoek. The click modular router. ACM Transactions on Computer Systems 18(3), August 2000, pages 263-297.
- Lalith Suresh P., and Ruben Merz. Ns-3-click: click modular router integration for ns-3. In Proc. of 3rd International ICST Workshop on NS-3 (WNS3), Barcelona, Spain. March, 2011.
- Michael Neufeld, Ashish Jain, and Dirk Grunwald. Nsclick: bridging network simulation and deployment. MSWiM '02: Proceedings of the 5th ACM international workshop on Modeling analysis and simulation of wireless and mobile systems, 2002, Atlanta, Georgia, USA. <http://doi.acm.org/10.1145/570758.570772>

## 9.2 Usage

### 9.2.1 Building Click

The first step is to clone Click from the github repository and build it:

```
$ git clone https://github.com/kohler/click
$ cd click/
$ ./configure --disable-linuxmodule --enable-nsclick --enable-wifi
$ make
```

The `--enable-wifi` flag may be skipped if you don't intend on using Click with Wifi. \* Note: You don't need to do a 'make install'.

Once Click has been built successfully, change into the ns-3 directory and configure ns-3 with Click Integration support:

```
$ ./waf configure --enable-examples --enable-tests --with-nsclick=/path/to/click/
↪source
```

Hint: If you have click installed one directory above ns-3 (such as in the ns-3-allinone directory), and the name of the directory is ‘click’ (or a symbolic link to the directory is named ‘click’), then the `--with-nsclick` specifier is not necessary; the ns-3 build system will successfully find the directory.

If it says ‘enabled’ beside ‘NS-3 Click Integration Support’, then you’re good to go. Note: If running modular ns-3, the minimum set of modules required to run all ns-3-click examples is wifi, csma and config-store.

Next, try running one of the examples:

```
$ ./waf --run nsclick-simple-lan
```

You may then view the resulting .pcap traces, which are named nsclick-simple-lan-0-0.pcap and nsclick-simple-lan-0-1.pcap.

## 9.2.2 Click Graph Instructions

The following should be kept in mind when making your Click graph:

- Only userlevel elements can be used.
- You will need to replace FromDevice and ToDevice elements with FromSimDevice and ToSimDevice elements.
- Packets to the kernel are sent up using ToSimDevice(tap0,IP).
- For any node, the device which sends/receives packets to/from the kernel, is named ‘tap0’. The remaining interfaces should be named eth0, eth1 and so forth (even if you’re using wifi). Please note that the device numbering should begin from 0. In future, this will be made flexible so that users can name devices in their Click file as they wish.
- A routing table element is a mandatory. The OUTports of the routing table element should correspond to the interface number of the device through which the packet will ultimately be sent out. Violating this rule will lead to really weird packet traces. This routing table element’s name should then be passed to the Ipv4ClickRouting protocol object as a simulation parameter. See the Click examples for details.
- The current implementation leaves Click with mainly L3 functionality, with ns-3 handling L2. We will soon begin working to support the use of MAC protocols on Click as well. This means that as of now, Click’s Wifi specific elements cannot be used with ns-3.

## 9.2.3 Debugging Packet Flows from Click

From any point within a Click graph, you may use the Print (<http://read.cs.ucla.edu/click/elements/print>) element and its variants for pretty printing of packet contents. Furthermore, you may generate pcap traces of packets flowing through a Click graph by using the ToDump (<http://read.cs.ucla.edu/click/elements/todump>) element as well. For instance:

```
myarpquerier
-> Print(fromarpquery,64)
-> ToDump(out_arpquery,PER_NODE 1)
-> ethout;
```

and ... will print the contents of packets that flow out of the ArpQuerier, then generate a pcap trace file which will have a suffix ‘out\_arpquery’, for each node using the Click file, before pushing packets onto ‘ethout’.

## 9.2.4 Helper

To have a node run Click, the easiest way would be to use the `ClickInternetStackHelper` class in your simulation script. For instance:

```
ClickInternetStackHelper click;
click.SetClickFile (myNodeContainer, "nsclick-simple-lan.click");
click.SetRoutingTableElement (myNodeContainer, "u/rt");
click.Install (myNodeContainer);
```

The example scripts inside `src/click/examples/` demonstrate the use of Click based nodes in different scenarios. The helper source can be found inside `src/click/helper/click-internet-stack-helper.{h,cc}`

## 9.2.5 Examples

The following examples have been written, which can be found in `src/click/examples/`:

- `nsclick-simple-lan.cc` and `nsclick-raw-wlan.cc`: A Click based node communicating with a normal ns-3 node without Click, using `Csma` and `Wifi` respectively. It also demonstrates the use of `TCP` on top of Click, something which the original `nsclick` implementation for NS-2 couldn't achieve.
- `nsclick-udp-client-server-csma.cc` and `nsclick-udp-client-server-wifi.cc`: A 3 node LAN (`Csma` and `Wifi` respectively) wherein 2 Click based nodes run a UDP client, that sends packets to a third Click based node running a UDP server.
- `nsclick-routing.cc`: One Click based node communicates to another via a third node that acts as an IP router (using the IP router Click configuration). This demonstrates routing using Click.

Scripts are available within `<click-dir>/conf/` that allow you to generate Click files for some common scenarios. The IP Router used in `nsclick-routing.cc` was generated from the `make-ip-conf.pl` file and slightly adapted to work with `ns-3-click`.

## 9.3 Validation

This model has been tested as follows:

- Unit tests have been written to verify the internals of `Ipv4ClickRouting`. This can be found in `src/click/ipv4-click-routing-test.cc`. These tests verify whether the methods inside `Ipv4ClickRouting` which deal with Device name to ID, IP Address from device name and Mac Address from device name bindings work as expected.
- The examples have been used to test Click with actual simulation scenarios. These can be found in `src/click/examples/`. These tests cover the following: the use of different kinds of transports on top of Click, `TCP/UDP`, whether Click nodes can communicate with non-Click based nodes, whether Click nodes can communicate with each other, using Click to route packets using static routing.
- Click has been tested with `Csma`, `Wifi` and `Point-to-Point` devices. Usage instructions are available in the preceding section.

## CSMA NETDEVICE

This is the introduction to CSMA NetDevice chapter, to complement the CSMA model doxygen.

### 10.1 Overview of the CSMA model

The *ns-3* CSMA device models a simple bus network in the spirit of Ethernet. Although it does not model any real physical network you could ever build or buy, it does provide some very useful functionality.

Typically when one thinks of a bus network Ethernet or IEEE 802.3 comes to mind. Ethernet uses CSMA/CD (Carrier Sense Multiple Access with Collision Detection with exponentially increasing backoff to contend for the shared transmission medium. The *ns-3* CSMA device models only a portion of this process, using the nature of the globally available channel to provide instantaneous (faster than light) carrier sense and priority-based collision “avoidance.” Collisions in the sense of Ethernet never happen and so the *ns-3* CSMA device does not model collision detection, nor will any transmission in progress be “jammed.”

#### 10.1.1 CSMA Layer Model

There are a number of conventions in use for describing layered communications architectures in the literature and in textbooks. The most common layering model is the ISO seven layer reference model. In this view the *CsmaNetDevice* and *CsmaChannel* pair occupies the lowest two layers – at the physical (layer one), and data link (layer two) positions. Another important reference model is that specified by RFC 1122, “Requirements for Internet Hosts – Communication Layers.” In this view the *CsmaNetDevice* and *CsmaChannel* pair occupies the lowest layer – the link layer. There is also a seemingly endless litany of alternative descriptions found in textbooks and in the literature. We adopt the naming conventions used in the IEEE 802 standards which speak of LLC, MAC, MII and PHY layering. These acronyms are defined as:

- LLC: Logical Link Control;
- MAC: Media Access Control;
- MII: Media Independent Interface;
- PHY: Physical Layer.

In this case the *LLC* and *MAC* are sublayers of the OSI data link layer and the *MI*I and *PHY* are sublayers of the OSI physical layer.

The “top” of the CSMA device defines the transition from the network layer to the data link layer. This transition is performed by higher layers by calling either *CsmaNetDevice*::Send or *CsmaNetDevice*::SendFrom.

In contrast to the IEEE 802.3 standards, there is no precisely specified PHY in the CSMA model in the sense of wire types, signals or pinouts. The “bottom” interface of the *CsmaNetDevice* can be thought of as as a kind of Media Independent Interface (MII) as seen in the “Fast Ethernet” (IEEE 802.3u) specifications. This MII interface fits into a

corresponding media independent interface on the `CsmaChannel`. You will not find the equivalent of a 10BASE-T or a 1000BASE-LX PHY.

The `CsmaNetDevice` calls the `CsmaChannel` through a media independent interface. There is a method defined to tell the channel when to start “wiggling the wires” using the method `CsmaChannel::TransmitStart`, and a method to tell the channel when the transmission process is done and the channel should begin propagating the last bit across the “wire”: `CsmaChannel::TransmitEnd`.

When the `TransmitEnd` method is executed, the channel will model a single uniform signal propagation delay in the medium and deliver copies of the packet to each of the devices attached to the packet via the `CsmaNetDevice::Receive` method.

There is a “pin” in the device media independent interface corresponding to “COL” (collision). The state of the channel may be sensed by calling `CsmaChannel::GetState`. Each device will look at this “pin” before starting a send and will perform appropriate backoff operations if required.

Properly received packets are forwarded up to higher levels from the `CsmaNetDevice` via a callback mechanism. The callback function is initialized by the higher layer (when the net device is attached) using `CsmaNetDevice::SetReceiveCallback` and is invoked upon “proper” reception of a packet by the net device in order to forward the packet up the protocol stack.

## 10.2 CSMA Channel Model

The class `CsmaChannel` models the actual transmission medium. There is no fixed limit for the number of devices connected to the channel. The `CsmaChannel` models a data rate and a speed-of-light delay which can be accessed via the attributes “DataRate” and “Delay” respectively. The data rate provided to the channel is used to set the data rates used by the transmitter sections of the CSMA devices connected to the channel. There is no way to independently set data rates in the devices. Since the data rate is only used to calculate a delay time, there is no limitation (other than by the data type holding the value) on the speed at which CSMA channels and devices can operate; and no restriction based on any kind of PHY characteristics.

The `CsmaChannel` has three states, `IDLE`, `TRANSMITTING` and `PROPAGATING`. These three states are “seen” instantaneously by all devices on the channel. By this we mean that if one device begins or ends a simulated transmission, all devices on the channel are *immediately* aware of the change in state. There is no time during which one device may see an `IDLE` channel while another device physically further away in the collision domain may have begun transmitting with the associated signals not propagated down the channel to other devices. Thus there is no need for collision detection in the `CsmaChannel` model and it is not implemented in any way.

We do, as the name indicates, have a Carrier Sense aspect to the model. Since the simulator is single threaded, access to the common channel will be serialized by the simulator. This provides a deterministic mechanism for contending for the channel. The channel is allocated (transitioned from state `IDLE` to state `TRANSMITTING`) on a first-come first-served basis. The channel always goes through a three state process:

```
IDLE -> TRANSMITTING -> PROPAGATING -> IDLE
```

The `TRANSMITTING` state models the time during which the source net device is actually wiggling the signals on the wire. The `PROPAGATING` state models the time after the last bit was sent, when the signal is propagating down the wire to the “far end.”

The transition to the `TRANSMITTING` state is driven by a call to `CsmaChannel::TransmitStart` which is called by the net device that transmits the packet. It is the responsibility of that device to end the transmission with a call to `CsmaChannel::TransmitEnd` at the appropriate simulation time that reflects the time elapsed to put all of the packet bits on the wire. When `TransmitEnd` is called, the channel schedules an event corresponding to a single speed-of-light delay. This delay applies to all net devices on the channel identically. You can think of a symmetrical hub in which the packet bits propagate to a central location and then back out equal length cables to the other devices on the channel. The single “speed of light” delay then corresponds to the time it takes for: 1) a signal to propagate from one



CsmaNetDevice through its cable to the hub; plus 2) the time it takes for the hub to forward the packet out a port; plus 3) the time it takes for the signal in question to propagate to the destination net device.

The CsmaChannel models a broadcast medium so the packet is delivered to all of the devices on the channel (including the source) at the end of the propagation time. It is the responsibility of the sending device to determine whether or not it receives a packet broadcast over the channel.

The CsmaChannel provides following Attributes:

- **DataRate:** The bitrate for packet transmission on connected devices;
- **Delay:** The speed of light transmission delay for the channel.

## 10.3 CSMA Net Device Model

The CSMA network device appears somewhat like an Ethernet device. The CsmaNetDevice provides following Attributes:

- **Address:** The Mac48Address of the device;
- **SendEnable:** Enable packet transmission if true;
- **ReceiveEnable:** Enable packet reception if true;
- **EncapsulationMode:** Type of link layer encapsulation to use;
- **RxErrorModel:** The receive error model;
- **TxQueue:** The transmit queue used by the device;
- **InterframeGap:** The optional time to wait between “frames”;
- **Rx:** A trace source for received packets;
- **Drop:** A trace source for dropped packets.

The CsmaNetDevice supports the assignment of a “receive error model.” This is an ErrorModel object that is used to simulate data corruption on the link.

Packets sent over the CsmaNetDevice are always routed through the transmit queue to provide a trace hook for packets sent out over the network. This transmit queue can be set (via attribute) to model different queuing strategies.

Also configurable by attribute is the encapsulation method used by the device. Every packet gets an EthernetHeader that includes the destination and source MAC addresses, and a length/type field. Every packet also gets an Ethernet-Trailer which includes the FCS. Data in the packet may be encapsulated in different ways.

By default, or by setting the “EncapsulationMode” attribute to “Dix”, the encapsulation is according to the DEC, Intel, Xerox standard. This is sometimes called EthernetII framing and is the familiar destination MAC, source MAC, EtherType, Data, CRC format.

If the “EncapsulationMode” attribute is set to “Llc”, the encapsulation is by LLC SNAP. In this case, a SNAP header is added that contains the EtherType (IP or ARP).

The other implemented encapsulation modes are IP\_ARP (set “EncapsulationMode” to “IpArp”) in which the length type of the Ethernet header receives the protocol number of the packet; or ETHERNET\_V1 (set “EncapsulationMode” to “EthernetV1”) in which the length type of the Ethernet header receives the length of the packet. A “Raw” encapsulation mode is defined but not implemented – use of the RAW mode results in an assertion.

Note that all net devices on a channel must be set to the same encapsulation mode for correct results. The encapsulation mode is not sensed at the receiver.

The CsmaNetDevice implements a random exponential backoff algorithm that is executed if the channel is determined to be busy (TRANSMITTING or PPROPAGATING) when the device wants to start propagating. This results in a random

delay of up to `pow(2, retries) - 1` microseconds before a retry is attempted. The default maximum number of retries is 1000.

## 10.4 Using the CsmNetDevice

The CSMA net devices and channels are typically created and configured using the associated `CsmaHelper` object. The various *ns-3* device helpers generally work in a similar way, and their use is seen in many of our example programs.

The conceptual model of interest is that of a bare computer “husk” into which you plug net devices. The bare computers are created using a `NodeContainer` helper. You just ask this helper to create as many computers (we call them `Nodes`) as you need on your network:

```
NodeContainer csmaNodes;  
csmaNodes.Create (nCsmNodes);
```

Once you have your nodes, you need to instantiate a `CsmaHelper` and set any attributes you may want to change.:

```
CsmaHelper csma;  
csma.SetChannelAttribute ("DataRate", StringValue ("100Mbps"));  
csma.SetChannelAttribute ("Delay", TimeValue (NanoSeconds (6560)));  
  
csma.SetDeviceAttribute ("EncapsulationMode", StringValue ("Dix"));  
csma.SetDeviceAttribute ("FrameSize", UIntegerValue (2000));
```

Once the attributes are set, all that remains is to create the devices and install them on the required nodes, and to connect the devices together using a CSMA channel. When we create the net devices, we add them to a container to allow you to use them in the future. This all takes just one line of code.:

```
NetDeviceContainer csmaDevices = csma.Install (csmaNodes);
```

We recommend thinking carefully about changing these Attributes, since it can result in behavior that surprises users. We allow this because we believe flexibility is important. As an example of a possibly surprising effect of changing Attributes, consider the following:

The `Mtu` Attribute indicates the Maximum Transmission Unit to the device. This is the size of the largest Protocol Data Unit (PDU) that the device can send. This Attribute defaults to 1500 bytes and corresponds to a number found in RFC 894, “A Standard for the Transmission of IP Datagrams over Ethernet Networks.” The number is actually derived from the maximum packet size for 10Base5 (full-spec Ethernet) networks – 1518 bytes. If you subtract DIX encapsulation overhead for Ethernet packets (18 bytes) you will end up with a maximum possible data size (MTU) of 1500 bytes. One can also find that the MTU for IEEE 802.3 networks is 1492 bytes. This is because LLC/SNAP encapsulation adds an extra eight bytes of overhead to the packet. In both cases, the underlying network hardware is limited to 1518 bytes, but the MTU is different because the encapsulation is different.

If one leaves the `Mtu` Attribute at 1500 bytes and changes the encapsulation mode Attribute to `Llc`, the result will be a network that encapsulates 1500 byte PDUs with LLC/SNAP framing resulting in packets of 1526 bytes. This would be illegal in many networks, but we allow you to do this. This results in a simulation that quite subtly does not reflect what you might be expecting since a real device would balk at sending a 1526 byte packet.

There also exist jumbo frames ( $1500 < \text{MTU} \leq 9000$  bytes) and super-jumbo ( $\text{MTU} > 9000$  bytes) frames that are not officially sanctioned by IEEE but are available in some high-speed (Gigabit) networks and NICs. In the CSMA model, one could leave the encapsulation mode set to `Dix`, and set the `Mtu` to 64000 bytes – even though an associated `CsmaChannel DataRate` was left at 10 megabits per second (certainly not Gigabit Ethernet). This would essentially model an Ethernet switch made out of vampire-tapped 1980s-style 10Base5 networks that support super-jumbo datagrams, which is certainly not something that was ever made, nor is likely to ever be made; however it is quite easy for you to configure.

Be careful about assumptions regarding what CSMA is actually modelling and how configuration (Attributes) may allow you to swerve considerably away from reality.

## 10.5 CSMA Tracing

Like all *ns-3* devices, the CSMA Model provides a number of trace sources. These trace sources can be hooked using your own custom trace code, or you can use our helper functions to arrange for tracing to be enabled on devices you specify.

### 10.5.1 Upper-Level (MAC) Hooks

From the point of view of tracing in the net device, there are several interesting points to insert trace hooks. A convention inherited from other simulators is that packets destined for transmission onto attached networks pass through a single “transmit queue” in the net device. We provide trace hooks at this point in packet flow, which corresponds (abstractly) only to a transition from the network to data link layer, and call them collectively the device MAC hooks.

When a packet is sent to the CSMA net device for transmission it always passes through the transmit queue. The transmit queue in the `CsmaNetDevice` inherits from `Queue`, and therefore inherits three trace sources:

- An Enqueue operation source (see `Queue::m_traceEnqueue`);
- A Dequeue operation source (see `Queue::m_traceDequeue`);
- A Drop operation source (see `Queue::m_traceDrop`).

The upper-level (MAC) trace hooks for the `CsmaNetDevice` are, in fact, exactly these three trace sources on the single transmit queue of the device.

The `m_traceEnqueue` event is triggered when a packet is placed on the transmit queue. This happens at the time that `CsmaNetDevice::Send` or `CsmaNetDevice::SendFrom` is called by a higher layer to queue a packet for transmission.

The `m_traceDequeue` event is triggered when a packet is removed from the transmit queue. Dequeues from the transmit queue can happen in three situations: 1) If the underlying channel is idle when the `CsmaNetDevice::Send` or `CsmaNetDevice::SendFrom` is called, a packet is dequeued from the transmit queue and immediately transmitted; 2) If the underlying channel is idle, a packet may be dequeued and immediately transmitted in an internal `TransmitCompleteEvent` that functions much like a transmit complete interrupt service routine; or 3) from the random exponential backoff handler if a timeout is detected.

Case (3) implies that a packet is dequeued from the transmit queue if it is unable to be transmitted according to the backoff rules. It is important to understand that this will appear as a Dequeued packet and it is easy to incorrectly assume that the packet was transmitted since it passed through the transmit queue. In fact, a packet is actually dropped by the net device in this case. The reason for this behavior is due to the definition of the `Queue Drop` event. The `m_traceDrop` event is, by definition, fired when a packet cannot be enqueued on the transmit queue because it is full. This event only fires if the queue is full and we do not overload this event to indicate that the `CsmaChannel` is “full.”

### 10.5.2 Lower-Level (PHY) Hooks

Similar to the upper level trace hooks, there are trace hooks available at the lower levels of the net device. We call these the PHY hooks. These events fire from the device methods that talk directly to the `CsmaChannel`.

The trace source `m_dropTrace` is called to indicate a packet that is dropped by the device. This happens in two cases: First, if the receive side of the net device is not enabled (see `CsmaNetDevice::m_receiveEnable` and the associated attribute “`ReceiveEnable`”).

The `m_dropTrace` is also used to indicate that a packet was discarded as corrupt if a receive error model is used (see `CsmaNetDevice::m_receiveErrorModel` and the associated attribute “`ReceiveErrorModel`”).

The other low-level trace source fires on reception of an accepted packet (see `CsmaNetDevice::m_rxTrace`). A packet is accepted if it is destined for the broadcast address, a multicast address, or to the MAC address assigned to the net device.

## 10.6 Summary

The ns3 CSMA model is a simplistic model of an Ethernet-like network. It supports a Carrier-Sense function and allows for Multiple Access to a shared medium. It is not physical in the sense that the state of the medium is instantaneously shared among all devices. This means that there is no collision detection required in this model and none is implemented. There will never be a “jam” of a packet already on the medium. Access to the shared channel is on a first-come first-served basis as determined by the simulator scheduler. If the channel is determined to be busy by looking at the global state, a random exponential backoff is performed and a retry is attempted.

Ns-3 Attributes provide a mechanism for setting various parameters in the device and channel such as addresses, encapsulation modes and error model selection. Trace hooks are provided in the usual manner with a set of upper level hooks corresponding to a transmit queue and used in ASCII tracing; and also a set of lower level hooks used in pcap tracing.

Although the ns-3 `CsmaChannel` and `CsmaNetDevice` does not model any kind of network you could build or buy, it does provide us with some useful functionality. You should, however, understand that it is explicitly not Ethernet or any flavor of IEEE 802.3 but an interesting subset.

## DSDV ROUTING

Destination-Sequenced Distance Vector (DSDV) routing protocol is a pro-active, table-driven routing protocol for MANETs developed by Charles E. Perkins and Pravin Bhagwat in 1994. It uses the hop count as metric in route selection.

This model was developed by [the ResiliNets research group](#) at the University of Kansas. A paper on this model exists at [this URL](#).

### 11.1 DSDV Routing Overview

**DSDV Routing Table:** Every node will maintain a table listing all the other nodes it has known either directly or through some neighbors. Every node has a single entry in the routing table. The entry will have information about the node's IP address, last known sequence number and the hop count to reach that node. Along with these details the table also keeps track of the nexthop neighbor to reach the destination node, the timestamp of the last update received for that node.

The DSDV update message consists of three fields, Destination Address, Sequence Number and Hop Count.

Each node uses 2 mechanisms to send out the DSDV updates. They are,

1. **Periodic Updates** Periodic updates are sent out after every `m_periodicUpdateInterval`(default:15s). In this update the node broadcasts out its entire routing table.
2. **Trigger Updates** Trigger Updates are small updates in-between the periodic updates. These updates are sent out whenever a node receives a DSDV packet that caused a change in its routing table. The original paper did not clearly mention when for what change in the table should a DSDV update be sent out. The current implementation sends out an update irrespective of the change in the routing table.

The updates are accepted based on the metric for a particular node. The first factor determining the acceptance of an update is the sequence number. It has to accept the update if the sequence number of the update message is higher irrespective of the metric. If the update with same sequence number is received, then the update with least metric (`hopCount`) is given precedence.

In highly mobile scenarios, there is a high chance of route fluctuations, thus we have the concept of weighted settling time where an update with change in metric will not be advertised to neighbors. The node waits for the settling time to make sure that it did not receive the update from its old neighbor before sending out that update.

The current implementation covers all the above features of DSDV. The current implementation also has a request queue to buffer packets that have no routes to destination. The default is set to buffer up to 5 packets per destination.

### 11.2 References

Link to the Paper: <http://portal.acm.org/citation.cfm?doi=190314.190336>



## DSR ROUTING

Dynamic Source Routing (DSR) protocol is a reactive routing protocol designed specifically for use in multi-hop wireless ad hoc networks of mobile nodes.

This model was developed by [the ResiliNets research group](#) at the University of Kansas.

### 12.1 DSR Routing Overview

This model implements the base specification of the Dynamic Source Routing (DSR) protocol. Implementation is based on [RFC 4728](#), with some extensions and modifications to the RFC specifications.

DSR operates on a on-demand behavior. Therefore, our DSR model buffers all packets while a route request packet (RREQ) is disseminated. We implement a packet buffer in `dsr-rsendbuff.cc`. The packet queue implements garbage collection of old packets and a queue size limit. When the packet is sent out from the send buffer, it will be queued in maintenance buffer for next hop acknowledgment.

The maintenance buffer then buffers the already sent out packets and waits for the notification of packet delivery. Protocol operation strongly depends on broken link detection mechanism. We implement the three heuristics recommended based the RFC as follows:

First, we use link layer feedback when possible, which is also the fastest mechanism of these three to detect link errors. A link is considered to be broken if frame transmission results in a transmission failure for all retries. This mechanism is meant for active links and works much faster than in its absence. DSR is able to detect the link layer transmission failure and notify that as broken. Recalculation of routes will be triggered when needed. If user does not want to use link layer acknowledgment, it can be tuned by setting “LinkAcknowledgment” attribute to false in “`dsr-routing.cc`”.

Second, passive acknowledgment should be used whenever possible. The node turns on “promiscuous” receive mode, in which it can receive packets not destined for itself, and when the node assures the delivery of that data packet to its destination, it cancels the passive acknowledgment timer.

Last, we use a network layer acknowledge scheme to notify the receipt of a packet. Route request packet will not be acknowledged or retransmitted.

The Route Cache implementation support garbage collection of old entries and state machine, as defined in the standard. It implements as a STL map container. The key is the destination IP address.

DSR operates with direct access to IP header, and operates between network and transport layer. When packet is sent out from transport layer, it passes itself to DSR and DSR header is appended.

We have two caching mechanisms: path cache and link cache. The path cache saves the whole path in the cache. The paths are sorted based on the hop count, and whenever one path is not able to be used, we change to the next path. The link cache is a slightly better design in the sense that it uses different subpaths and uses Implemented Link Cache using Dijkstra algorithm, and this part is implemented by Song Luan <[lsuper@mail.ustc.edu.cn](mailto:lsuper@mail.ustc.edu.cn)>.

The following optional protocol optimizations aren't implemented:

- Flow state
- First Hop External (F), Last Hop External (L) flags
- Handling unknown DSR options
- **Two types of error headers:**
  1. flow state not supported option
  2. unsupported option (not going to happen in simulation)

### 12.1.1 DSR update in ns-3.17

We originally used “TxErrHeader” in Ptr<WifiMac> to indicate the transmission error of a specific packet in link layer, however, it was not working quite correctly since even when the packet was dropped, this header was not recorded in the trace file. We used to a different path on implementing the link layer notification mechanism. We look into the trace file by finding packet receive event. If we find one receive event for the data packet, we count that as the indicator for successful data delivery.

### 12.1.2 Useful parameters

Parameter	Description	Default
MaxSendBuffLen	Maximum number of packets that can be stored <b>in</b> send buffer	64
MaxSendBuffTime	Maximum time packets can be queued <b>in</b> the send buffer	Seconds(30)
MaxMaintLen	Maximum number of packets that can be stored <b>in</b> maintenance buffer	50
MaxMaintTime	Maximum time packets can be queued <b>in</b> maintenance buffer	Seconds(30)
MaxCacheLen	Maximum number of route entries that can be stored <b>in</b> route cache	64
RouteCacheTimeout	Maximum time the route cache can be queued <b>in</b> route cache	Seconds(300)
RreqRetries	Maximum number of retransmissions <b>for</b> request discovery of a route	16
CacheType	Use Link Cache <b>or</b> use Path Cache	"LinkCache"
LinkAcknowledgment	Enable Link layer acknowledgment mechanism	<b>True</b>



### 12.1.3 Implementation modification

- **The DsrFsHeader has added 3 fields: message type, source id, destination id, and these changes only for post-processing**
  1. Message type is used to identify the data packet from control packet
  2. source id is used to identify the real source of the data packet since we have to deliver the packet hop-by-hop and the Ipv4Header is not carrying the real source and destination ip address as needed
  3. destination id is for same reason of above
- Route Reply header is not word-aligned in DSR RFC, change it to word-aligned in implementation
- DSR works as a shim header between transport and network protocol, it needs its own forwarding mechanism, we are changing the packet transmission to hop-by-hop delivery, so we added two fields in dsr fixed header to notify packet delivery

### 12.1.4 Current Route Cache implementation

This implementation used “path cache”, which is simple to implement and ensures loop-free paths:

- the path cache has automatic expire policy
- the cache saves multiple route entries for a certain destination and sort the entries based on hop counts
- the MaxEntriesEachDst can be tuned to change the maximum entries saved for a single destination
- when adding multiple routes for one destination, the route is compared based on hop-count and expire time, the one with less hop count or relatively new route is favored
- Future implementation may include “link cache” as another possibility

## 12.2 DSR Instructions

The following should be kept in mind when running DSR as routing protocol:

- NodeTraversalTime is the time it takes to traverse two neighboring nodes and should be chosen to fit the transmission range
- PassiveAckTimeout is the time a packet in maintenance buffer wait for passive acknowledgment, normally set as two times of NodeTraversalTime
- RouteCacheTimeout should be set smaller value when the nodes’ velocity become higher. The default value is 300s.

## 12.3 Helper

To have a node run DSR, the easiest way would be to use the DsrHelper and DsrMainHelpers in your simulation script. For instance:

```
DsrHelper dsr;
DsrMainHelper dsrMain;
dsrMain.Install (dsr, adhocNodes);
```

The example scripts inside `src/dsr/examples/` demonstrate the use of DSR based nodes in different scenarios. The helper source can be found inside `src/dsr/helper/dsr-main-helper.{h,cc}` and `src/dsr/helper/dsr-helper.{h,cc}`

## 12.4 Examples

The example can be found in `src/dsr/examples/`:

- `dsr.cc` use DSR as routing protocol within a traditional MANETs environment[3].

DSR is also built in the routing comparison case in `examples/routing/`:

- `manet-routing-compare.cc` is a comparison case with built in MANET routing protocols and can generate its own results.

## 12.5 Validation

This model has been tested as follows:

- Unit tests have been written to verify the internals of DSR. This can be found in `src/dsr/test/dsr-test-suite.cc`. These tests verify whether the methods inside DSR module which deal with packet buffer, headers work correctly.
- Simulation cases similar to [3] have been tested and have comparable results.
- `manet-routing-compare.cc` has been used to compare DSR with three of other routing protocols.

A paper was presented on these results at the Workshop on ns-3 in 2011.

## 12.6 Limitations

The model is not fully compliant with **RFC 4728**. As an example, Dsr fixed size header has been extended and it is four octets longer than the RFC specification. As a consequence, the DSR headers can not be correctly decoded by Wireshark.

The model full compliance with the RFC is planned for the future.

## 12.7 References

[1] Original paper: <http://www.monarch.cs.rice.edu/monarch-papers/dsr-chapter00.pdf>

[2] RFC 4728 <http://www6.ietf.org/rfc/rfc4728.txt>

[3] Broch's comparison paper: <http://www.monarch.cs.rice.edu/monarch-papers/mobicom98.ps>

## EMULATION OVERVIEW

*ns-3* has been designed for integration into testbed and virtual machine environments. We have addressed this need by providing two kinds of net devices. The first kind of device is a file descriptor net device (`FdNetDevice`), which is a generic device type that can read and write from a file descriptor. By associating this file descriptor with different things on the host system, different capabilities can be provided. For instance, the `FdNetDevice` can be associated with an underlying packet socket to provide emulation capabilities. This allows *ns-3* simulations to send data on a “real” network. The second kind, called a `TapBridge NetDevice` allows a “real” host to participate in an *ns-3* simulation as if it were one of the simulated nodes. An *ns-3* simulation may be constructed with any combination of simulated or emulated devices.

**Note:** Prior to *ns-3.17*, the emulation capability was provided by a special device called an `Emu NetDevice`; the `Emu NetDevice` has been replaced by the `FdNetDevice`.

One of the use-cases we want to support is that of a testbed. A concrete example of an environment of this kind is the ORBIT testbed. ORBIT is a laboratory emulator/field trial network arranged as a two dimensional grid of 400 802.11 radio nodes. We integrate with ORBIT by using their “imaging” process to load and run *ns-3* simulations on the ORBIT array. We can use our `EmuFdNetDevice` to drive the hardware in the testbed and we can accumulate results either using the *ns-3* tracing and logging functions, or the native ORBIT data gathering techniques. See <http://www.orbit-lab.org/> for details on the ORBIT testbed.

A simulation of this kind is shown in the following figure:

You can see that there are separate hosts, each running a subset of a “global” simulation. Instead of an *ns-3* channel connecting the hosts, we use real hardware provided by the testbed. This allows *ns-3* applications and protocol stacks attached to a simulation node to communicate over real hardware.

We expect the primary use for this configuration will be to generate repeatable experimental results in a real-world network environment that includes all of the *ns-3* tracing, logging, visualization and statistics gathering tools.

In what can be viewed as essentially an inverse configuration, we allow “real” machines running native applications and protocol stacks to integrate with an *ns-3* simulation. This allows for the simulation of large networks connected to a real machine, and also enables virtualization. A simulation of this kind is shown in the following figure:

Here, you will see that there is a single host with a number of virtual machines running on it. An *ns-3* simulation is shown running in the virtual machine shown in the center of the figure. This simulation has a number of nodes with associated *ns-3* applications and protocol stacks that are talking to an *ns-3* channel through native simulated *ns-3* net devices.

There are also two virtual machines shown at the far left and far right of the figure. These VMs are running native (Linux) applications and protocol stacks. The VM is connected into the simulation by a Linux Tap net device. The user-mode handler for the Tap device is instantiated in the simulation and attached to a proxy node that represents the native VM in the simulation. These handlers allow the Tap devices on the native VMs to behave as if they were *ns-3* net devices in the simulation VM. This, in turn, allows the native software and protocol suites in the native VMs to believe that they are connected to the simulated *ns-3* channel.

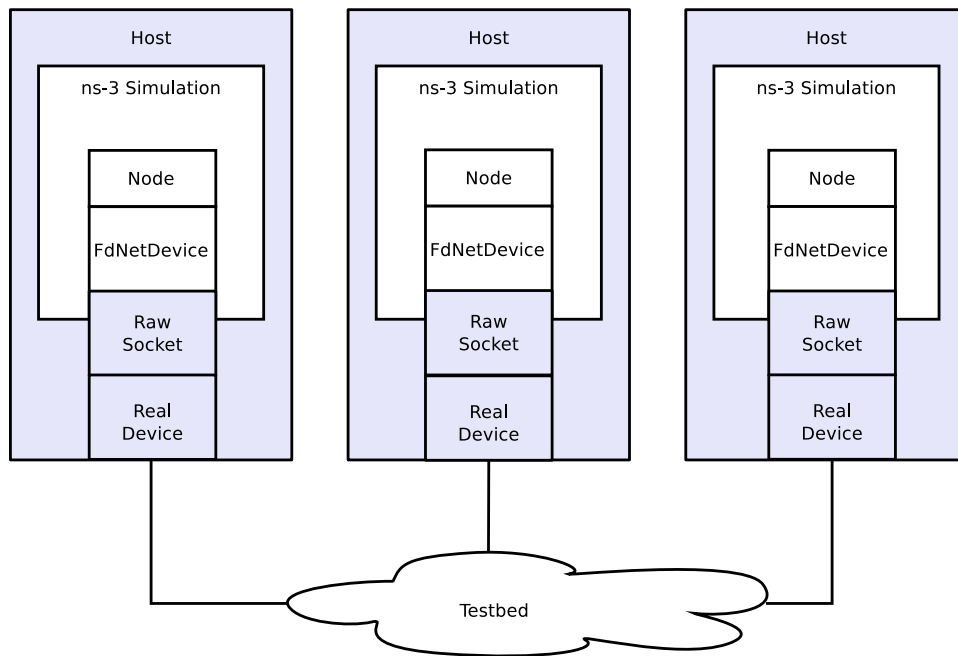

Fig. 1: Example Implementation of Testbed Emulation.

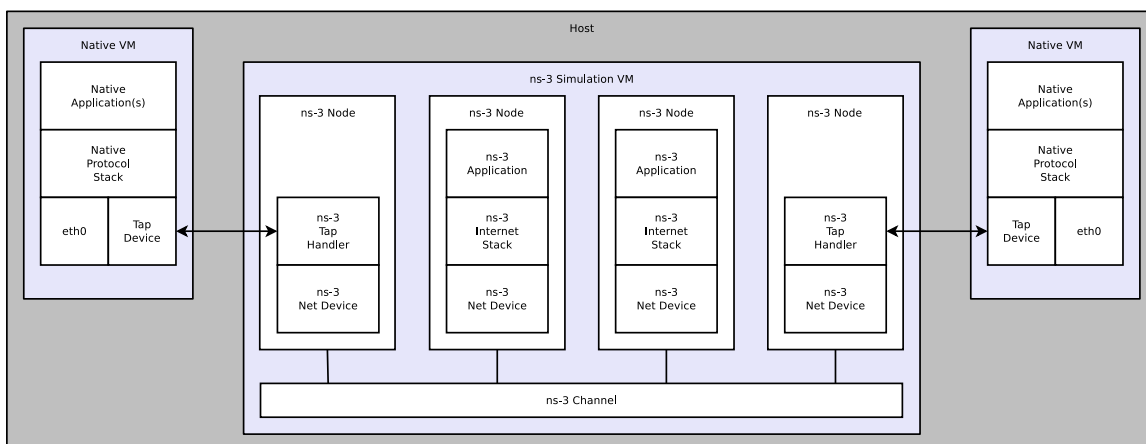

Fig. 2: Implementation overview of emulated channel.

We expect the typical use case for this environment will be to analyze the behavior of native applications and protocol suites in the presence of large simulated *ns-3* networks.

The basic testbed mode of emulation uses raw sockets. Two other variants (netmap-based and DPDK-based emulation) have been recently added; these make use of more recent network interface cards that make use of directly-mapped memory capabilities to improve packet processing efficiency.

For more details:

- *FdNetDevice* chapter.
- *NetmapNetDevice* chapter.
- *DpdkNetDevice* chapter.
- *TapBridge* chapter.



## ENERGY FRAMEWORK

Energy consumption is a key issue for wireless devices, and wireless network researchers often need to investigate the energy consumption at a node or in the overall network while running network simulations in ns-3. This requires ns-3 to support energy consumption modeling. Further, as concepts such as fuel cells and energy scavenging are becoming viable for low power wireless devices, incorporating the effect of these emerging technologies into simulations requires support for modeling diverse energy sources in ns-3. The ns-3 Energy Framework provides the basis for energy consumption, energy source and energy harvesting modeling.

### 14.1 Model Description

The source code for the Energy Framework is currently at: `src/energy`.

#### 14.1.1 Design

The ns-3 Energy Framework is composed of 3 parts: Energy Source, Device Energy Model and Energy Harvester. The framework is implemented into the `src/energy/models` folder.

##### Energy Source

The Energy Source represents the power supply on each node. A node can have one or more energy sources, and each energy source can be connected to multiple device energy models. Connecting an energy source to a device energy model implies that the corresponding device draws power from the source. The basic functionality of the Energy Source is to provide energy for devices on the node. When energy is completely drained from the Energy Source, it notifies the devices on node such that each device can react to this event. Further, each node can access the Energy Source Objects for information such as remaining energy or energy fraction (battery level). This enables the implementation of energy aware protocols in ns-3.

In order to model a wide range of power supplies such as batteries, the Energy Source must be able to capture characteristics of these supplies. There are 2 important characteristics or effects related to practical batteries:

**Rate Capacity Effect** Decrease of battery lifetime when the current draw is higher than the rated value of the battery.

**Recovery Effect** Increase of battery lifetime when the battery is alternating between discharge and idle states.

In order to incorporate the Rate Capacity Effect, the Energy Source uses current draw from all the devices on the same node to calculate energy consumption. Moreover, multiple Energy Harvesters can be connected to the Energy Source in order to replenish its energy. The Energy Source periodically polls all the devices and energy harvesters on the same node to calculate the total current drain and hence the energy consumption. When a device changes state, its corresponding Device Energy Model will notify the Energy Source of this change and new total current draw will be calculated. Similarly, every Energy Harvester update triggers an update to the connected Energy Source.

The Energy Source base class keeps a list of devices (Device Energy Model objects) and energy harvesters (Energy Harvester objects) that are using the particular Energy Source as power supply. When energy is completely drained, the Energy Source will notify all devices on this list. Each device can then handle this event independently, based on the desired behavior that should be followed in case of power outage.

### Device Energy Model

The Device Energy Model is the energy consumption model of a device installed on the node. It is designed to be a state based model where each device is assumed to have a number of states, and each state is associated with a power consumption value. Whenever the state of the device changes, the corresponding Device Energy Model will notify the Energy Source of the new current draw of the device. The Energy Source will then calculate the new total current draw and update the remaining energy.

The Device Energy Model can also be used for devices that do not have finite number of states. For example, in an electric vehicle, the current draw of the motor is determined by its speed. Since the vehicle's speed can take continuous values within a certain range, it is infeasible to define a set of discrete states of operation. However, by converting the speed value into current directly, the same set of Device Energy Model APIs can still be used.

### Energy Harvester

The energy harvester represents the elements that harvest energy from the environment and recharge the Energy Source to which it is connected. The energy harvester includes the complete implementation of the actual energy harvesting device (e.g., a solar panel) and the environment (e.g., the solar radiation). This means that in implementing an energy harvester, the energy contribution of the environment and the additional energy requirements of the energy harvesting device such as the conversion efficiency and the internal power consumption of the device needs to be jointly modeled.

### WiFi Radio Energy Model

The WiFi Radio Energy Model is the energy consumption model of a Wifi net device. It provides a state for each of the available states of the PHY layer: Idle, CcaBusy, Tx, Rx, ChannelSwitch, Sleep, Off. Each of such states is associated with a value (in Ampere) of the current draw (see below for the corresponding attribute names). A Wifi Radio Energy Model PHY Listener is registered to the Wifi PHY in order to be notified of every Wifi PHY state transition. At every transition, the energy consumed in the previous state is computed and the energy source is notified in order to update its remaining energy.

The Wifi Tx Current Model gives the possibility to compute the current draw in the transmit state as a function of the nominal tx power (in dBm), as observed in several experimental measurements. To this purpose, the Wifi Radio Energy Model PHY Listener is notified of the nominal tx power used to transmit the current frame and passes such a value to the Wifi Tx Current Model which takes care of updating the current draw in the Tx state. Hence, the energy consumption is correctly computed even if the Wifi Remote Station Manager performs per-frame power control. Currently, a Linear Wifi Tx Current Model is implemented which computes the tx current as a linear function (according to parameters that can be specified by the user) of the nominal tx power in dBm.

The Wifi Radio Energy Model offers the possibility to specify a callback that is invoked when the energy source is depleted. If such a callback is not specified when the Wifi Radio Energy Model Helper is used to install the model on a device, a callback is implicitly made so that the Wifi PHY is put in the OFF mode (hence no frame is transmitted nor received afterwards) when the energy source is depleted. Likewise, it is possible to specify a callback that is invoked when the energy source is recharged (which might occur in case an energy harvester is connected to the energy source). If such a callback is not specified when the Wifi Radio Energy Model Helper is used to install the model on a device, a callback is implicitly made so that the Wifi PHY is resumed from the OFF mode when the energy source is recharged.



## 14.1.2 Future Work

For Device Energy Models, we are planning to include support for other PHY layer models provided in ns-3 such as WiMAX, and to model the energy consumptions of other non communicating devices, like a generic sensor and a CPU. For Energy Sources, we are planning to included new types of Energy Sources such as Supercapacitor and Nickel-Metal Hydride (Ni-MH) battery. For the Energy Harvesters, we are planning to implement an energy harvester that recharges the energy sources according to the power levels defined in a user customizable dataset of real measurements.

## 14.1.3 References

## 14.2 Usage

The main way that ns-3 users will typically interact with the Energy Framework is through the helper API and through the publicly visible attributes of the framework. The helper API is defined in `src/energy/helper/*.h`.

In order to use the energy framework, the user must install an Energy Source for the node of interest, the corresponding Device Energy Model for the network devices and, if necessary, the one or more Energy Harvester. Energy Source (objects) are aggregated onto each node by the Energy Source Helper. In order to allow multiple energy sources per node, we aggregate an Energy Source Container rather than directly aggregating a source object.

The Energy Source object keeps a list of Device Energy Model and Energy Harvester objects using the source as power supply. Device Energy Model objects are installed onto the Energy Source by the Device Energy Model Helper, while Energy Harvester object are installed by the Energy Harvester Helper. User can access the Device Energy Model objects through the Energy Source object to obtain energy consumption information of individual devices. Moreover, the user can access to the Energy Harvester objects in order to gather information regarding the current harvestable power and the total energy harvested by the harvester.

### 14.2.1 Examples

The example directories, `src/examples/energy` and `examples/energy`, contain some basic code that shows how to set up the framework.

### 14.2.2 Helpers

#### Energy Source Helper

Base helper class for Energy Source objects, this helper Aggregates Energy Source object onto a node. Child implementation of this class creates the actual Energy Source object.

#### Device Energy Model Helper

Base helper class for Device Energy Model objects, this helper attaches Device Energy Model objects onto Energy Source objects. Child implementation of this class creates the actual Device Energy Model object.

#### Energy Harvesting Helper

Base helper class for Energy Harvester objects, this helper attaches Energy Harvester objects onto Energy Source objects. Child implementation of this class creates the actual Energy Harvester object.

### 14.2.3 Attributes

Attributes differ between Energy Sources, Devices Energy Models and Energy Harvesters implementations, please look at the specific child class for details.

#### Basic Energy Source

- `BasicEnergySourceInitialEnergyJ`: Initial energy stored in basic energy source.
- `BasicEnergySupplyVoltageV`: Initial supply voltage for basic energy source.
- `PeriodicEnergyUpdateInterval`: Time between two consecutive periodic energy updates.

#### RV Battery Model

- `RvBatteryModelPeriodicEnergyUpdateInterval`: RV battery model sampling interval.
- `RvBatteryModelOpenCircuitVoltage`: RV battery model open circuit voltage.
- `RvBatteryModelCutoffVoltage`: RV battery model cutoff voltage.
- `RvBatteryModelAlphaValue`: RV battery model alpha value.
- `RvBatteryModelBetaValue`: RV battery model beta value.
- `RvBatteryModelNumOfTerms`: The number of terms of the infinite sum for estimating battery level.

#### WiFi Radio Energy Model

- `IdleCurrentA`: The default radio Idle current in Ampere.
- `CcaBusyCurrentA`: The default radio CCA Busy State current in Ampere.
- `TxCURRENTA`: The radio Tx current in Ampere.
- `RxCURRENTA`: The radio Rx current in Ampere.
- `SwitchingCurrentA`: The default radio Channel Switch current in Ampere.
- `SleepCurrentA`: The radio Sleep current in Ampere.
- `TxCURRENTModel`: A pointer to the attached tx current model.

#### Basic Energy Harvester

- `PeriodicHarvestedPowerUpdateInterval`: Time between two consecutive periodic updates of the harvested power.
- `HarvestablePower`: Random variables that represents the amount of power that is provided by the energy harvester.

### 14.2.4 Tracing

Traced values differ between Energy Sources, Devices Energy Models and Energy Harvesters implementations, please look at the specific child class for details.

### Basic Energy Source

- `RemainingEnergy`: Remaining energy at `BasicEnergySource`.

### RV Battery Model

- `RvBatteryModelBatteryLevel`: RV battery model battery level.
- `RvBatteryModelBatteryLifetime`: RV battery model battery lifetime.

### WiFi Radio Energy Model

- `TotalEnergyConsumption`: Total energy consumption of the radio device.

### Basic Energy Harvester

- `HarvestedPower`: Current power provided by the `BasicEnergyHarvester`.
- `TotalEnergyHarvested`: Total energy harvested by the `BasicEnergyHarvester`.

## 14.2.5 Validation

Comparison of the Energy Framework against actual devices have not been performed. Current implementation of the Energy Framework is checked numerically for computation errors. The RV battery model is validated by comparing results with what was presented in the original RV battery model paper.



## FILE DESCRIPTOR NETDEVICE

The `src/fd-net-device` module provides the `FdNetDevice` class, which is able to read and write traffic using a file descriptor provided by the user. This file descriptor can be associated to a TAP device, to a raw socket, to a user space process generating/consuming traffic, etc. The user has full freedom to define how external traffic is generated and *ns-3* traffic is consumed.

Different mechanisms to associate a simulation to external traffic can be provided through helper classes. Three specific helpers are provided:

- `EmuFdNetDeviceHelper` (to associate the *ns-3* device with a physical device in the host machine)
- `TapFdNetDeviceHelper` (to associate the *ns-3* device with the file descriptor from a tap device in the host machine)
- `PlanteLabFdNetDeviceHelper` (to automate the creation of tap devices in PlanetLab nodes, enabling *ns-3* simulations that can send and receive traffic though the Internet using PlanetLab resource).

### 15.1 Model Description

The source code for this module lives in the directory `src/fd-net-device`.

The `FdNetDevice` is a special type of *ns-3* `NetDevice` that reads traffic to and from a file descriptor. That is, unlike pure simulation `NetDevice` objects that write frames to and from a simulated channel, this `FdNetDevice` directs frames out of the simulation to a file descriptor. The file descriptor may be associated to a Linux TUN/TAP device, to a socket, or to a user-space process.

It is up to the user of this device to provide a file descriptor. The type of file descriptor being provided determines what is being modelled. For instance, if the file descriptor provides a raw socket to a WiFi card on the host machine, the device being modelled is a WiFi device.

From the conceptual “top” of the device looking down, it looks to the simulated node like a device supporting a 48-bit IEEE MAC address that can be bridged, supports broadcast, and uses IPv4 ARP or IPv6 Neighbor Discovery, although these attributes can be tuned on a per-use-case basis.

#### 15.1.1 Design

The `FdNetDevice` implementation makes use of a reader object, extended from the `FdReader` class in the *ns-3* `src/core` module, which manages a separate thread from the main *ns-3* execution thread, in order to read traffic from the file descriptor.

Upon invocation of the `StartDevice` method, the reader object is initialized and starts the reading thread. Before device start, a file descriptor must be previously associated to the `FdNetDevice` with the `SetFileDescriptor` invocation.

The creation and configuration of the file descriptor can be left to a number of helpers, described in more detail below. When this is done, the invocation of `SetFileDescriptor` is responsibility of the helper and must not be directly invoked by the user.

Upon reading an incoming frame from the file descriptor, the reader will pass the frame to the `ReceiveCallback` method, whose task it is to schedule the reception of the frame by the device as a *ns-3* simulation event. Since the new frame is passed from the reader thread to the main *ns-3* simulation thread, thread-safety issues are avoided by using the `ScheduleWithContext` call instead of the regular `Schedule` call.

In order to avoid overwhelming the scheduler when the incoming data rate is too high, a counter is kept with the number of frames that are currently scheduled to be received by the device. If this counter reaches the value given by the `RxQueueSize` attribute in the device, then the new frame will be dropped silently.

The actual reception of the new frame by the device occurs when the scheduled `ForwardUp` method is invoked by the simulator. This method acts as if a new frame had arrived from a channel attached to the device. The device then decapsulates the frame, removing any layer 2 headers, and forwards it to upper network stack layers of the node. The `ForwardUp` method will remove the frame headers, according to the frame encapsulation type defined by the `EncapsulationMode` attribute, and invoke the receive callback passing an IP packet.

An extra header, the PI header, can be present when the file descriptor is associated to a TAP device that was created without setting the `IFF_NO_PI` flag. This extra header is removed if `EncapsulationMode` is set to `DIXPI` value.

In the opposite direction, packets generated inside the simulation that are sent out through the device, will be passed to the `Send` method, which will in turn invoke the `SendFrom` method. The latter method will add the necessary layer 2 headers, and simply write the newly created frame to the file descriptor.

### 15.1.2 Scope and Limitations

Users of this device are cautioned that there is no flow control across the file descriptor boundary, when using in emulation mode. That is, in a Linux system, if the speed of writing network packets exceeds the ability of the underlying physical device to buffer the packets, backpressure up to the writing application will be applied to avoid local packet loss. No such flow control is provided across the file descriptor interface, so users must be aware of this limitation.

As explained before, the `RxQueueSize` attribute limits the number of packets that can be pending to be received by the device. Frames read from the file descriptor while the number of pending packets is in its maximum will be silently dropped.

The `mtu` of the device defaults to the Ethernet II MTU value. However, helpers are supposed to set the `mtu` to the right value to reflect the characteristics of the network interface associated to the file descriptor. If no helper is used, then the responsibility of setting the correct `mtu` value for the device falls back to the user. The size of the read buffer on the file descriptor reader is set to the `mtu` value in the `StartDevice` method.

The `FdNetDevice` class currently supports three encapsulation modes, `DIX` for Ethernet II frames, `LLC` for 802.2 LLC/SNAP frames, and `DIXPI` for Ethernet II frames with an additional TAP PI header. This means that traffic traversing the file descriptor is expected to be Ethernet II compatible. IEEE 802.1q (VLAN) tagging is not supported. Attaching an `FdNetDevice` to a wireless interface is possible as long as the driver provides Ethernet II frames to the socket API. Note that to associate a `FdNetDevice` to a wireless card in ad-hoc mode, the MAC address of the device must be set to the real card MAC address, else any incoming traffic a fake MAC address will be discarded by the driver.

As mentioned before, three helpers are provided with the `fd-net-device` module. Each individual helper (file descriptor type) may have platform limitations. For instance, threading, real-time simulation mode, and the ability to create TUN/TAP devices are prerequisites to using the provided helpers. Support for these modes can be found in the output of the `waf configure` step, e.g.:

```

Threading Primitives      : enabled
Real Time Simulator      : enabled
Emulated Net Device      : enabled
Tap Bridge                : enabled

```

It is important to mention that while testing the `FdNetDevice` we have found an upper bound limit for TCP throughput when using 1Gb Ethernet links of 60Mbps. This limit is most likely due to the processing power of the computers involved in the tests.

## 15.2 Usage

The usage pattern for this type of device is similar to other net devices with helpers that install to node pointers or node containers. When using the base `FdNetDeviceHelper` the user is responsible for creating and setting the file descriptor by himself.

```

FdNetDeviceHelper fd;
NetDeviceContainer devices = fd.Install (nodes);

// file descriptor generation
...

device->SetFileDescriptor (fd);

```

Most commonly a `FdNetDevice` will be used to interact with the host system. In these cases it is almost certain that the user will want to run in real-time emulation mode, and to enable checksum computations. The typical program statements are as follows:

```

GlobalValue::Bind ("SimulatorImplementationType", StringValue (
↪ "ns3::RealttimeSimulatorImpl"));
GlobalValue::Bind ("ChecksumEnabled", BooleanValue (true));

```

The easiest way to set up an experiment that interacts with a Linux host system is to use the `Emu` and `Tap` helpers. Perhaps the most unusual part of these helper implementations relates to the requirement for executing some of the code with super-user permissions. Rather than force the user to execute the entire simulation as root, we provide a small “creator” program that runs as root and does any required high-permission sockets work. The easiest way to set the right privileges for the “creator” programs, is by enabling the `--enable-sudo` flag when performing `waf` configure.

We do a similar thing for both the `Emu` and the `Tap` devices. The high-level view is that the `CreateFileDescriptor` method creates a local interprocess (Unix) socket, forks, and executes the small creation program. The small program, which runs as `suid root`, creates a raw socket and sends back the raw socket file descriptor over the Unix socket that is passed to it as a parameter. The raw socket is passed as a control message (sometimes called ancillary data) of type `SCM_RIGHTS`.

### 15.2.1 Helpers

#### EmuFdNetDeviceHelper

The `EmuFdNetDeviceHelper` creates a raw socket to an underlying physical device, and provides the socket descriptor to the `FdNetDevice`. This allows the `ns-3` simulation to read frames from and write frames to a network device on the host.

The emulation helper permits to transparently integrate a simulated `ns-3` node into a network composed of real nodes.

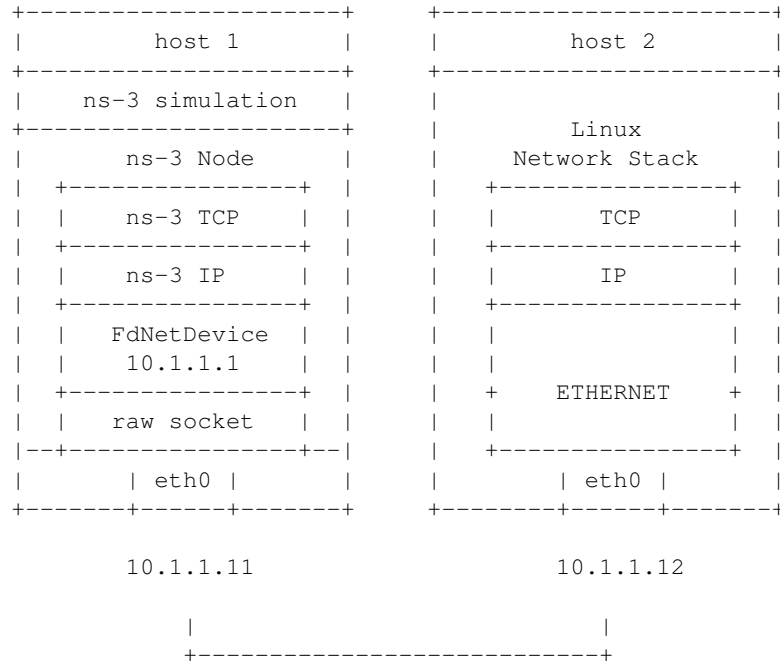

This helper replaces the functionality of the `EmuNetDevice` found in *ns-3* prior to ns-3.17, by bringing this type of device into the common framework of the `FdNetDevice`. The `EmuNetDevice` was deprecated in favor of this new helper.

The device is configured to perform MAC spoofing to separate simulation network traffic from other network traffic that may be flowing to and from the host.

One can use this helper in a testbed situation where the host on which the simulation is running has a specific interface of interest which drives the testbed hardware. You would also need to set this specific interface into promiscuous mode and provide an appropriate device name to the *ns-3* simulation. Additionally, hardware offloading of segmentation and checksums should be disabled.

The helper only works if the underlying interface is up and in promiscuous mode. Packets will be sent out over the device, but we use MAC spoofing. The MAC addresses will be generated (by default) using the Organizationally Unique Identifier (OUI) 00:00:00 as a base. This vendor code is not assigned to any organization and so should not conflict with any real hardware.

It is always up to the user to determine that using these MAC addresses is okay on your network and won't conflict with anything else (including another simulation using such devices) on your network. If you are using the emulated `FdNetDevice` configuration in separate simulations, you must consider global MAC address assignment issues and ensure that MAC addresses are unique across all simulations. The emulated net device respects the MAC address provided in the `Address` attribute so you can do this manually. For larger simulations, you may want to set the OUI in the MAC address allocation function.

Before invoking the `Install` method, the correct device name must be configured on the helper using the `SetDeviceName` method. The device name is required to identify which physical device should be used to open the raw socket.

```

EmuFdNetDeviceHelper emu;
emu.SetDeviceName (deviceName);
NetDeviceContainer devices = emu.Install (node);
Ptr<NetDevice> device = devices.Get (0);
device->SetAttribute ("Address", Mac48AddressValue (Mac48Address::Allocate ()));

```



## TapFdNetDeviceHelper

A Tap device is a special type of Linux device for which one end of the device appears to the kernel as a virtual `net_device`, and the other end is provided as a file descriptor to user-space. This file descriptor can be passed to the `FdNetDevice`. Packets forwarded to the TAP device by the kernel will show up in the `FdNetDevice` in *ns-3*.

Users should note that this usage of TAP devices is different than that provided by the `TapBridge` `NetDevice` found in `src/tap-bridge`. The model in this helper is as follows:

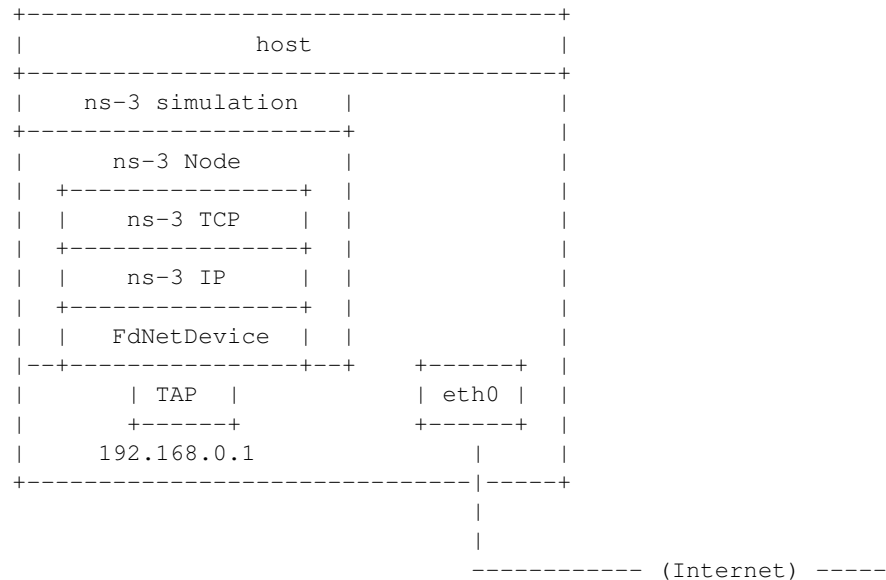

In the above, the configuration requires that the host be able to forward traffic generated by the simulation to the Internet.

The model in `TapBridge` (in another module) is as follows:

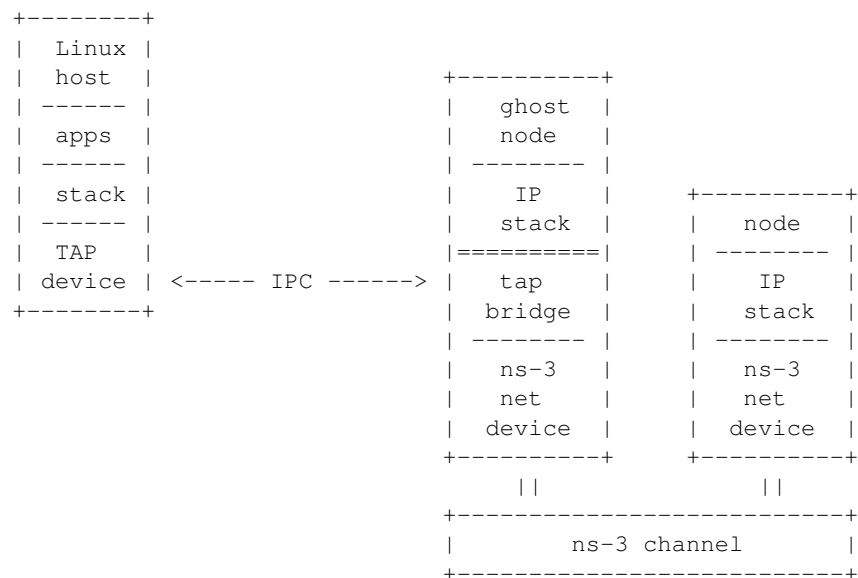

In the above, packets instead traverse *ns-3* `NetDevices` and `Channels`.

The usage pattern for this example is that the user sets the MAC address and either (or both) the IPv4 and IPv6

addresses and masks on the device, and the PI header if needed. For example:

```
TapFdNetDeviceHelper helper;
helper.SetDeviceName (deviceName);
helper.SetModePi (modePi);
helper.SetTapIpv4Address (tapIp);
helper.SetTapIpv4Mask (tapMask);
...
helper.Install (node);
```

### PlanetLabFdNetDeviceHelper

PlanetLab is a world wide distributed network testbed composed of nodes connected to the Internet. Running ns-3 simulations in PlanetLab nodes using the PlanetLabFdNetDeviceHelper allows to send simulated traffic generated by ns-3 directly to the Internet. This setup can be useful to validate ns-3 Internet protocols or other future protocols implemented in ns-3.

To run experiments using PlanetLab nodes it is required to have a PlanetLab account. Only members of PlanetLab partner institutions can obtain such accounts ( for more information visit <http://www.planet-lab.org/> or <http://www.planet-lab.eu> ). Once the account is obtained, a PlanetLab *slice* must be requested in order to conduct experiments. A slice represents an experiment unit related to a group of PlanetLab users, and can be associated to virtual machines in different PlanetLab nodes. Slices can also be customized by adding configuration tags to it (this is done by PlanetLab administrators).

The PlanetLabFdNetDeviceHelper creates TAP devices on PlanetLab nodes using specific PlanetLab mechanisms (i.e. the vsys system), and associates the TAP device to a FdNetDevice in ns-3. The functionality provided by this helper is similar to that provided by the FdTapNetDeviceHelper, except that the underlying mechanisms to create the TAP device are different.

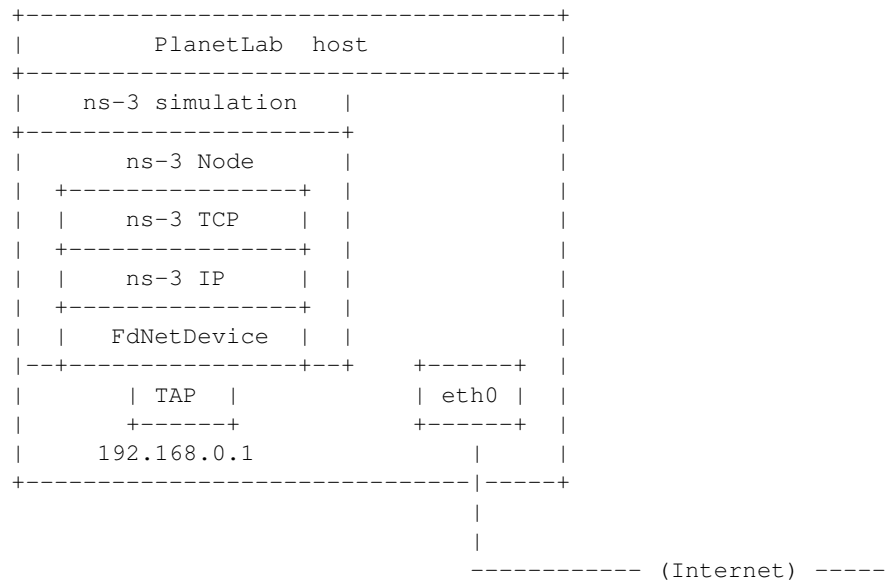

In order to be able to assign private IPv4 addresses to the TAP devices, account holders must request the *vsys\_vnet* tag to be added to their slice by PlanetLab administrators. The *vsys\_vnet* tag is associated to private network segment and only addresses from this segment can be used in experiments.

The syntax used to create a TAP device with this helper is similar to that used for the previously described helpers:

```
PlanetLabFdNetDeviceHelper helper;
helper.SetTapIpAddress (tapIp);
helper.SetTapMask (tapMask);
...
helper.Install (node);
```

PlanetLab nodes have a Fedora based distribution, so ns-3 can be installed following the instructions for ns-3 Linux installation.

## 15.2.2 Attributes

The `FdNetDevice` provides a number of attributes:

- `Address`: The MAC address of the device
- `Start`: The simulation start time to spin up the device thread
- `Stop`: The simulation start time to stop the device thread
- `EncapsulationMode`: Link-layer encapsulation format
- **`RxQueueSize`: The buffer size of the read queue on the file descriptor** thread (default of 1000 packets)

`Start` and `Stop` do not normally need to be specified unless the user wants to limit the time during which this device is active. `Address` needs to be set to some kind of unique MAC address if the simulation will be interacting with other real devices somehow using real MAC addresses. Typical code:

```
device->SetAttribute ("Address", Mac48AddressValue (Mac48Address::Allocate ()));
```

## 15.2.3 Output

Ascii and PCAP tracing is provided similar to the other *ns-3* `NetDevice` types, through the helpers, such as (e.g.):

```
:: EmuFdNetDeviceHelper emu; NetDeviceContainer devices = emu.Install (node); ... emu.EnablePcap ("emu-
ping", device, true);
```

The standard set of Mac-level `NetDevice` trace sources is provided.

- `MaxTx`: Trace source triggered when *ns-3* provides the device with a new frame to send
- `MaxTxDrop`: Trace source if write to file descriptor fails
- `MaxPromiscRx`: Whenever any valid Mac frame is received
- `MaxRx`: Whenever a valid Mac frame is received for this device
- `Sniffer`: Non-promiscuous packet sniffer
- `PromiscSniffer`: Promiscuous packet sniffer (for tcpdump-like traces)

## 15.2.4 Examples

Several examples are provided:

- `dummy-network.cc`: This simple example creates two nodes and interconnects them with a Unix pipe by passing the file descriptors from the socketpair into the `FdNetDevice` objects of the respective nodes.
- `realtime-dummy-network.cc`: Same as `dummy-network.cc` but uses the real time simulator implementation instead of the default one.

- `fd2fd-onoff.cc`: This example is aimed at measuring the throughput of the `FdNetDevice` in a pure simulation. For this purpose two `FdNetDevices`, attached to different nodes but in a same simulation, are connected using a socket pair. TCP traffic is sent at a saturating data rate.
- `fd-emu-onoff.cc`: This example is aimed at measuring the throughput of the `FdNetDevice` when using the `EmuFdNetDeviceHelper` to attach the simulated device to a real device in the host machine. This is achieved by saturating the channel with TCP traffic.
- `fd-emu-ping.cc`: This example uses the `EmuFdNetDeviceHelper` to send ICMP traffic over a real channel.
- `fd-emu-udp-echo.cc`: This example uses the `EmuFdNetDeviceHelper` to send UDP traffic over a real channel.
- `fd-planetlab-ping.cc`: This example shows how to set up an experiment to send ICMP traffic from a PlanetLab node to the Internet.
- `fd-tap-ping.cc`: This example uses the `TapFdNetDeviceHelper` to send ICMP traffic over a real channel.

## FLOW MONITOR

### 16.1 Model Description

The source code for the new module lives in the directory `src/flow-monitor`.

The Flow Monitor module goal is to provide a flexible system to measure the performance of network protocols. The module uses probes, installed in network nodes, to track the packets exchanged by the nodes, and it will measure a number of parameters. Packets are divided according to the flow they belong to, where each flow is defined according to the probe's characteristics (e.g., for IP, a flow is defined as the packets with the same {protocol, source (IP, port), destination (IP, port)} tuple).

The statistics are collected for each flow can be exported in XML format. Moreover, the user can access the probes directly to request specific stats about each flow.

#### 16.1.1 Design

Flow Monitor module is designed in a modular way. It can be extended by subclassing `ns3::FlowProbe` and `ns3::FlowClassifier`. Typically, a subclass of `ns3::FlowProbe` works by listening to the appropriate class Traces, and then uses its own `ns3::FlowClassifier` subclass to classify the packets passing through each node.

Each Probe can try to listen to other classes traces (e.g., `ns3::Ipv4FlowProbe` will try to use any `ns3::NetDevice` trace named `TxQueue/Drop`) but this is something that the user should not rely into blindly, because the trace is not guaranteed to be in every type of `ns3::NetDevice`. As an example, `CsmaNetDevice` and `PointToPointNetDevice` have a `TxQueue/Drop` trace, while `WifiNetDevice` does not.

The full module design is described in [\[FlowMonitor\]](#)

#### 16.1.2 Scope and Limitations

At the moment, probes and classifiers are available only for IPv4 and IPv6.

IPv4 and IPv6 probes will classify packets in four points:

- When a packet is sent (`SendOutgoing IPv[4,6]` traces)
- When a packet is forwarded (`UnicastForward IPv[4,6]` traces)
- When a packet is received (`LocalDeliver IPv[4,6]` traces)
- When a packet is dropped (`Drop IPv[4,6]` traces)

Since the packets are tracked at IP level, any retransmission caused by L4 protocols (e.g., TCP) will be seen by the probe as a new packet.

A Tag will be added to the packet (`ns3::Ipv[4,6]FlowProbeTag`). The tag will carry basic packet's data, useful for the packet's classification.

It must be underlined that only L4 (TCP, UDP) packets are, so far, classified. Moreover, only unicast packets will be classified. These limitations may be removed in the future.

The data collected for each flow are:

- `timeFirstTxPacket`: when the first packet in the flow was transmitted;
- `timeLastTxPacket`: when the last packet in the flow was transmitted;
- `timeFirstRxPacket`: when the first packet in the flow was received by an end node;
- `timeLastRxPacket`: when the last packet in the flow was received;
- `delaySum`: the sum of all end-to-end delays for all received packets of the flow;
- `jitterSum`: the sum of all end-to-end delay jitter (delay variation) values for all received packets of the flow, as defined in [RFC 3393](#);
- `txBytes`, `txPackets`: total number of transmitted bytes / packets for the flow;
- `rxBytes`, `rxPackets`: total number of received bytes / packets for the flow;
- `lostPackets`: total number of packets that are assumed to be lost (not reported over 10 seconds);
- `timesForwarded`: the number of times a packet has been reportedly forwarded;
- `delayHistogram`, `jitterHistogram`, `packetSizeHistogram`: histogram versions for the delay, jitter, and packet sizes, respectively;
- `packetsDropped`, `bytesDropped`: the number of lost packets and bytes, divided according to the loss reason code (defined in the probe).

It is worth pointing out that the probes measure the packet bytes including IP headers. The L2 headers are not included in the measure.

These stats will be written in XML form upon request (see the Usage section).

### The “lost” packets problem

At the end of a simulation, Flow Monitor could report about “lost” packets, i.e., packets that Flow Monitor have lost track of.

It is important to keep in mind that Flow Monitor records the packets statistics by intercepting them at a given network level - let's say at IP level. When the simulation ends, any packet queued for transmission below the IP level will be considered as lost.

It is strongly suggested to consider this point when using Flow Monitor. The user can choose to:

- Ignore the lost packets (if their number is a statistically irrelevant quantity), or
- Stop the Applications before the actual Simulation End time, leaving enough time between the two for the queued packets to be processed.

The second method is the suggested one. Usually a few seconds are enough (the exact value depends on the network type).

It is important to stress that “lost” packets could be anywhere in the network, and could count toward the received packets or the dropped ones. Ideally, their number should be zero or a minimal fraction of the other ones, i.e., they should be “statistically irrelevant”.

### 16.1.3 References

## 16.2 Usage

The module usage is extremely simple. The helper will take care of about everything.

The typical use is:

```
// Flow monitor
Ptr<FlowMonitor> flowMonitor;
FlowMonitorHelper flowHelper;
flowMonitor = flowHelper.InstallAll();

-yourApplicationsContainer-.Stop (Seconds (stop_time));;
Simulator::Stop (Seconds (stop_time+cleanup_time));
Simulator::Run ();

flowMonitor->SerializeToXmlFile ("NameOfFile.xml", true, true);
```

the `SerializeToXmlFile ()` function 2nd and 3rd parameters are used respectively to activate/deactivate the histograms and the per-probe detailed stats. Other possible alternatives can be found in the Doxygen documentation, while `cleanup_time` is the time needed by in-flight packets to reach their destinations.

### 16.2.1 Helpers

The helper API follows the pattern usage of normal helpers. Through the helper you can install the monitor in the nodes, set the monitor attributes, and print the statistics.

One important thing is: the `ns3::FlowMonitorHelper` must be instantiated only once in the main.

### 16.2.2 Attributes

The module provides the following attributes in `ns3::FlowMonitor`:

- `MaxPerHopDelay` (Time, default 10s): The maximum per-hop delay that should be considered;
- `StartTime` (Time, default 0s): The time when the monitoring starts;
- `DelayBinWidth` (double, default 0.001): The width used in the delay histogram;
- `JitterBinWidth` (double, default 0.001): The width used in the jitter histogram;
- `PacketSizeBinWidth` (double, default 20.0): The width used in the packetSize histogram;
- `FlowInterruptionsBinWidth` (double, default 0.25): The width used in the flowInterruptions histogram;
- `FlowInterruptionsMinTime` (double, default 0.5): The minimum inter-arrival time that is considered a flow interruption.

### 16.2.3 Output

The main model output is an XML formatted report about flow statistics. An example is:

```

<?xml version="1.0" ?>
<FlowMonitor>
  <FlowStats>
    <Flow flowId="1" timeFirstTxPacket="+0.0ns" timeFirstRxPacket="+20067198.0ns"
↪timeLastTxPacket="+2235764408.0ns" timeLastRxPacket="+2255831606.0ns" delaySum=
↪"+138731526300.0ns" jitterSum="+1849692150.0ns" lastDelay="+20067198.0ns" txBytes=
↪"2149400" rxBytes="2149400" txPackets="3735" rxPackets="3735" lostPackets="0"
↪timesForwarded="7466">
    </Flow>
  </FlowStats>
  <Ipv4FlowClassifier>
    <Flow flowId="1" sourceAddress="10.1.3.1" destinationAddress="10.1.2.2" protocol="6
↪" sourcePort="49153" destinationPort="50000" />
  </Ipv4FlowClassifier>
  <Ipv6FlowClassifier>
  </Ipv6FlowClassifier>
  <FlowProbes>
    <FlowProbe index="0">
      <FlowStats flowId="1" packets="3735" bytes="2149400" delayFromFirstProbeSum="+0.
↪0ns" >
      </FlowStats>
    </FlowProbe>
    <FlowProbe index="2">
      <FlowStats flowId="1" packets="7466" bytes="2224020" delayFromFirstProbeSum=
↪"+199415389258.0ns" >
      </FlowStats>
    </FlowProbe>
    <FlowProbe index="4">
      <FlowStats flowId="1" packets="3735" bytes="2149400" delayFromFirstProbeSum=
↪"+138731526300.0ns" >
      </FlowStats>
    </FlowProbe>
  </FlowProbes>
</FlowMonitor>

```

The output was generated by a TCP flow from 10.1.3.1 to 10.1.2.2.

It is worth noticing that the index 2 probe is reporting more packets and more bytes than the other probes. That's a perfectly normal behaviour, as packets are fragmented at IP level in that node.

It should also be observed that the receiving node's probe (index 4) doesn't count the fragments, as the reassembly is done before the probing point.

## 16.2.4 Examples

The examples are located in *src/flow-monitor/examples*.

Moreover, the following examples use the flow-monitor module:

- *examples/matrix-topology/matrix-topology.cc*
- *examples/routing/manet-routing-compare.cc*
- *examples/routing/simple-global-routing.cc*
- *examples/tcp/tcp-variants-comparison.cc*
- *examples/wireless/multirate.cc*
- *examples/wireless/wifi-hidden-terminal.cc*



### 16.2.5 Troubleshooting

Do not define more than one `ns3::FlowMonitorHelper` in the simulation.

## 16.3 Validation

The paper in the references contains a full description of the module validation against a test network.

Tests are provided to ensure the Histogram correct functionality.



## INTERNET MODELS (IP, TCP, ROUTING, UDP, INTERNET APPLICATIONS)

### 17.1 Internet Stack

#### 17.1.1 Internet stack aggregation

A bare class `Node` is not very useful as-is; other objects must be aggregated to it to provide useful node functionality.

The *ns-3* source code directory `src/internet` provides implementation of TCP/IPv4- and IPv6-related components. These include IPv4, ARP, UDP, TCP, IPv6, Neighbor Discovery, and other related protocols.

Internet Nodes are not subclasses of class `Node`; they are simply `Nodes` that have had a bunch of IP-related objects aggregated to them. They can be put together by hand, or via a helper function `InternetStackHelper::Install ()` which does the following to all nodes passed in as arguments:

```
void
InternetStackHelper::Install (Ptr<Node> node) const
{
    if (m_ipv4Enabled)
    {
        /* IPv4 stack */
        if (node->GetObject<Ipv4> () != 0)
        {
            NS_FATAL_ERROR ("InternetStackHelper::Install (): Aggregating "
                             "an InternetStack to a node with an existing Ipv4 object");
            return;
        }

        CreateAndAggregateObjectFromTypeId (node, "ns3::ArpL3Protocol");
        CreateAndAggregateObjectFromTypeId (node, "ns3::Ipv4L3Protocol");
        CreateAndAggregateObjectFromTypeId (node, "ns3::Icmpv4L4Protocol");
        // Set routing
        Ptr<Ipv4> ipv4 = node->GetObject<Ipv4> ();
        Ptr<Ipv4RoutingProtocol> ipv4Routing = m_routing->Create (node);
        ipv4->SetRoutingProtocol (ipv4Routing);
    }

    if (m_ipv6Enabled)
    {
        /* IPv6 stack */
        if (node->GetObject<Ipv6> () != 0)
        {
            NS_FATAL_ERROR ("InternetStackHelper::Install (): Aggregating "
```

(continues on next page)

(continued from previous page)

```

        "an InternetStack to a node with an existing Ipv6 object");
    return;
}

CreateAndAggregateObjectFromTypeId (node, "ns3::Ipv6L3Protocol");
CreateAndAggregateObjectFromTypeId (node, "ns3::Icmpv6L4Protocol");
// Set routing
Ptr<Ipv6> ipv6 = node->GetObject<Ipv6> ();
Ptr<Ipv6RoutingProtocol> ipv6Routing = m_routingv6->Create (node);
ipv6->SetRoutingProtocol (ipv6Routing);

/* register IPv6 extensions and options */
ipv6->RegisterExtensions ();
ipv6->RegisterOptions ();
}

if (m_ipv4Enabled || m_ipv6Enabled)
{
    /* UDP and TCP stacks */
    CreateAndAggregateObjectFromTypeId (node, "ns3::UdpL4Protocol");
    node->AggregateObject (m_tcpFactory.Create<Object> ());
    Ptr<PacketSocketFactory> factory = CreateObject<PacketSocketFactory> ();
    node->AggregateObject (factory);
}
}

```

Where multiple implementations exist in *ns-3* (TCP, IP routing), these objects are added by a factory object (TCP) or by a routing helper (m\_routing).

Note that the routing protocol is configured and set outside this function. By default, the following protocols are added:

```

void InternetStackHelper::Initialize ()
{
    SetTcp ("ns3::TcpL4Protocol");
    Ipv4StaticRoutingHelper staticRouting;
    Ipv4GlobalRoutingHelper globalRouting;
    Ipv4ListRoutingHelper listRouting;
    Ipv6ListRoutingHelper listRoutingv6;
    Ipv6StaticRoutingHelper staticRoutingv6;
    listRouting.Add (staticRouting, 0);
    listRouting.Add (globalRouting, -10);
    listRoutingv6.Add (staticRoutingv6, 0);
    SetRoutingHelper (listRouting);
    SetRoutingHelper (listRoutingv6);
}

```

By default, IPv4 and IPv6 are enabled.

## Internet Node structure

An IP-capable Node (an *ns-3* Node augmented by aggregation to have one or more IP stacks) has the following internal structure.

## Layer-3 protocols

At the lowest layer, sitting above the NetDevices, are the “layer 3” protocols, including IPv4, IPv6, ARP and so on. The class `Ipv4L3Protocol` is an implementation class whose public interface is typically class `Ipv4`, but the `Ipv4L3Protocol` public API is also used internally at present.

In class `Ipv4L3Protocol`, one method described below is `Receive ()`:

```
/**
 * Lower layer calls this method after calling L3Demux::Lookup
 * The ARP subclass needs to know from which NetDevice this
 * packet is coming to:
 *   - implement a per-NetDevice ARP cache
 *   - send back arp replies on the right device
 */
void Receive( Ptr<NetDevice> device, Ptr<const Packet> p, uint16_t protocol,
const Address &from, const Address &to, NetDevice::PacketType packetType);
```

First, note that the `Receive ()` function has a matching signature to the `ReceiveCallback` in the class `Node`. This function pointer is inserted into the `Node`’s protocol handler when `AddInterface ()` is called. The actual registration is done with a statement such as follows:

```
RegisterProtocolHandler ( MakeCallback (&Ipv4Protocol::Receive, ipv4),
                          Ipv4L3Protocol::PROT_NUMBER, 0);
```

The `Ipv4L3Protocol` object is aggregated to the `Node`; there is only one such `Ipv4L3Protocol` object. Higher-layer protocols that have a packet to send down to the `Ipv4L3Protocol` object can call `GetObject<Ipv4L3Protocol> ()` to obtain a pointer, as follows:

```
Ptr<Ipv4L3Protocol> ipv4 = m_node->GetObject<Ipv4L3Protocol> ();
if (ipv4 != 0)
{
    ipv4->Send (packet, saddr, daddr, PROT_NUMBER);
}
```

This class nicely demonstrates two techniques we exploit in *ns-3* to bind objects together: callbacks, and object aggregation.

Once IPv4 routing has determined that a packet is for the local node, it forwards it up the stack. This is done with the following function:

```
void
Ipv4L3Protocol::LocalDeliver (Ptr<const Packet> packet, Ipv4Header const&ip, uint32_t_
↪iif)
```

The first step is to find the right `Ipv4L4Protocol` object, based on IP protocol number. For instance, TCP is registered in the demux as protocol number 6. Finally, the `Receive()` function on the `Ipv4L4Protocol` (such as `TcpL4Protocol::Receive` is called.

We have not yet introduced the class `Ipv4Interface`. Basically, each `NetDevice` is paired with an IPv4 representation of such device. In Linux, this class `Ipv4Interface` roughly corresponds to the struct `in_device`; the main purpose is to provide address-family specific information (addresses) about an interface.

All the classes have appropriate traces in order to track sent, received and lost packets. The users is encouraged to use them so to find out if (and where) a packet is dropped. A common mistake is to forget the effects of local queues when sending packets, e.g., the ARP queue. This can be particularly puzzling when sending jumbo packets or packet bursts using UDP. The ARP cache pending queue is limited (3 datagrams) and IP packets might be fragmented, easily

overflowing the ARP cache queue size. In those cases it is useful to increase the ARP cache pending size to a proper value, e.g.:

```
Config::SetDefault ("ns3::ArpCache::PendingQueueSize", UIntegerValue (MAX_BURST_SIZE/  
↳L2MTU*3));
```

The IPv6 implementation follows a similar architecture. Dual-stacked nodes (one with support for both IPv4 and IPv6) will allow an IPv6 socket to receive IPv4 connections as a standard dual-stacked system does. A socket bound and listening to an IPv6 endpoint can receive an IPv4 connection and will return the remote address as an IPv4-mapped address. Support for the IPV6\_V6ONLY socket option does not currently exist.

## Layer-4 protocols and sockets

We next describe how the transport protocols, sockets, and applications tie together. In summary, each transport protocol implementation is a socket factory. An application that needs a new socket

For instance, to create a UDP socket, an application would use a code snippet such as the following:

```
Ptr<Udp> udpSocketFactory = GetNode ()->GetObject<Udp> ();  
Ptr<Socket> m_socket = socketFactory->CreateSocket ();  
m_socket->Bind (m_local_address);  
...
```

The above will query the node to get a pointer to its UDP socket factory, will create one such socket, and will use the socket with an API similar to the C-based sockets API, such as `Connect ()` and `Send ()`. The address passed to the `Bind ()`, `Connect ()`, or `Send ()` functions may be a `Ipv4Address`, `Ipv6Address`, or `Address`. If a `Address` is passed in and contains anything other than a `Ipv4Address` or `Ipv6Address`, these functions will return an error. The `Bind (void)` and `Bind6 (void)` functions bind to “0.0.0.0” and “::” respectively.

The socket can also be bound to a specific `NetDevice` though the `BindToNetDevice (Ptr<NetDevice> netdevice)` function. `BindToNetDevice (Ptr<NetDevice> netdevice)` will bind the socket to “0.0.0.0” and “::” (equivalent to calling `Bind ()` and `Bind6 ()`), unless the socket has been already bound to a specific address. Summarizing, the correct sequence is:

```
Ptr<Udp> udpSocketFactory = GetNode ()->GetObject<Udp> ();  
Ptr<Socket> m_socket = socketFactory->CreateSocket ();  
m_socket->BindToNetDevice (n_netDevice);  
...
```

or:

```
Ptr<Udp> udpSocketFactory = GetNode ()->GetObject<Udp> ();  
Ptr<Socket> m_socket = socketFactory->CreateSocket ();  
m_socket->Bind (m_local_address);  
m_socket->BindToNetDevice (n_netDevice);  
...
```

The following raises an error:

```
Ptr<Udp> udpSocketFactory = GetNode ()->GetObject<Udp> ();  
Ptr<Socket> m_socket = socketFactory->CreateSocket ();  
m_socket->BindToNetDevice (n_netDevice);  
m_socket->Bind (m_local_address);  
...
```

See the chapter on *ns-3* sockets for more information.

We have described so far a socket factory (e.g. `class Udp`) and a socket, which may be specialized (e.g., `class UdpSocket`). There are a few more key objects that relate to the specialized task of demultiplexing a packet to one or more receiving sockets. The key object in this task is class `Ipv4EndPointDemux`. This demultiplexer stores objects of class `Ipv4EndPoint`. This class holds the addressing/port tuple (local port, local address, destination port, destination address) associated with the socket, and a receive callback. This receive callback has a receive function registered by the socket. The `Lookup ()` function to `Ipv4EndPointDemux` returns a list of `Ipv4EndPoint` objects (there may be a list since more than one socket may match the packet). The layer-4 protocol copies the packet to each `Ipv4EndPoint` and calls its `ForwardUp ()` method, which then calls the `Receive ()` function registered by the socket.

An issue that arises when working with the sockets API on real systems is the need to manage the reading from a socket, using some type of I/O (e.g., blocking, non-blocking, asynchronous, ...). *ns-3* implements an asynchronous model for socket I/O; the application sets a callback to be notified of received data ready to be read, and the callback is invoked by the transport protocol when data is available. This callback is specified as follows:

```
void Socket::SetRecvCallback (Callback<void, Ptr<Socket>,
                             Ptr<Packet>,
                             const Address&> receivedData);
```

The data being received is conveyed in the `Packet` data buffer. An example usage is in class `PacketSink`:

```
m_socket->SetRecvCallback (MakeCallback(&PacketSink::HandleRead, this));
```

To summarize, internally, the UDP implementation is organized as follows:

- a `UdpImpl` class that implements the UDP socket factory functionality
- a `UdpL4Protocol` class that implements the protocol logic that is socket-independent
- a `UdpSocketImpl` class that implements socket-specific aspects of UDP
- a class called `Ipv4EndPoint` that stores the addressing tuple (local port, local address, destination port, destination address) associated with the socket, and a receive callback for the socket.

## IP-capable node interfaces

Many of the implementation details, or internal objects themselves, of IP-capable `Node` objects are not exposed at the simulator public API. This allows for different implementations; for instance, replacing the native *ns-3* models with ported TCP/IP stack code.

The C++ public APIs of all of these objects is found in the `src/network` directory, including principally:

- `address.h`
- `socket.h`
- `node.h`
- `packet.h`

These are typically base class objects that implement the default values used in the implementation, implement access methods to get/set state variables, host attributes, and implement publicly-available methods exposed to clients such as `CreateSocket`.

## Example path of a packet

These two figures show an example stack trace of how packets flow through the Internet Node objects.

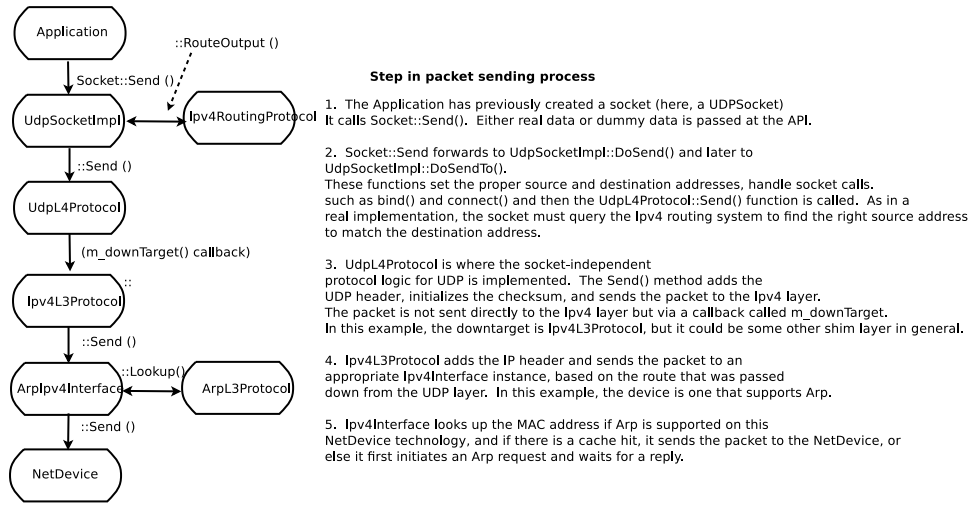

Fig. 1: Send path of a packet.

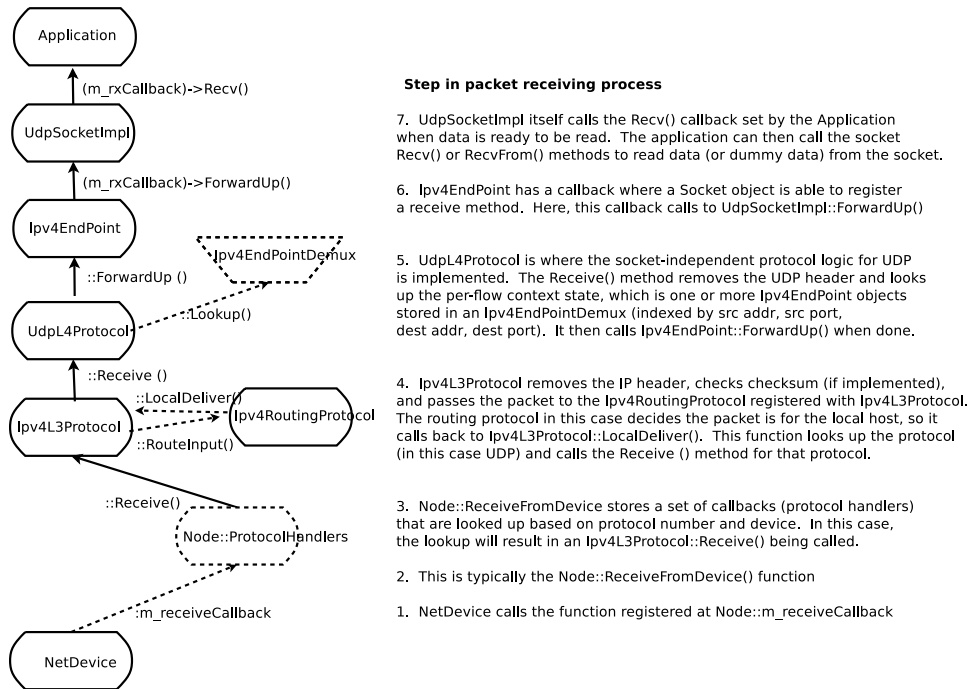

Fig. 2: Receive path of a packet.



## 17.2 IPv4

This chapter describes the *ns-3* IPv4 address assignment and basic components tracking.

### 17.2.1 IPv4 addresses assignment

In order to use IPv4 on a network, the first thing to do is assigning IPv4 addresses.

Any IPv4-enabled *ns-3* node will have at least one NetDevice: the `ns3::LoopbackNetDevice`. The loopback device address is `127.0.0.1`. All the other NetDevices will have one (or more) IPv4 addresses.

Note that, as today, *ns-3* does not have a NAT module, and it does not follow the rules about filtering private addresses (**RFC 1918**): `10.0.0.0/8`, `172.16.0.0/12`, and `192.168.0.0/16`. These addresses are routed as any other address. This behaviour could change in the future.

IPv4 global addresses can be:

- manually assigned
- assigned through DHCP

*ns-3* can use both methods, and it's quite important to understand the implications of both.

#### Manually assigned IPv4 addresses

This is probably the easiest and most used method. As an example:

```
Ptr<Node> n0 = CreateObject<Node> ();
Ptr<Node> n1 = CreateObject<Node> ();
NodeContainer net (n0, n1);
CsmaHelper csma;
NetDeviceContainer ndc = csma.Install (net);

NS_LOG_INFO ("Assign IPv4 Addresses.");
Ipv4AddressHelper ipv4;
ipv4.SetBase (Ipv4Address ("192.168.1.0"), NetMask ("/24"));
Ipv4InterfaceContainer ic = ipv4.Assign (ndc);
```

This method will add two global IPv4 addresses to the nodes.

Note that the addresses are assigned in sequence. As a consequence, the first Node / NetDevice will have “192.168.1.1”, the second “192.168.1.2” and so on.

It is possible to repeat the above to assign more than one address to a node. However, due to the `Ipv4AddressHelper` singleton nature, one should first assign all the addresses of a network, then change the network base (`SetBase`), then do a new assignment.

Alternatively, it is possible to assign a specific address to a node:

```
Ptr<Node> n0 = CreateObject<Node> ();
NodeContainer net (n0);
CsmaHelper csma;
NetDeviceContainer ndc = csma.Install (net);

NS_LOG_INFO ("Specifically Assign an IPv4 Address.");
Ipv4AddressHelper ipv4;
Ptr<NetDevice> device = ndc.Get (0);
```

(continues on next page)

(continued from previous page)

```

Ptr<Node> node = device->GetNode ();
Ptr<Ipv4> ipv4proto = node->GetObject<Ipv4> ();
int32_t ifIndex = 0;
ifIndex = ipv4proto->GetInterfaceForDevice (device);
Ipv4InterfaceAddress ipv4Addr = Ipv4InterfaceAddress (Ipv4Address ("192.168.1.42"),
↳NetMask ("/24"));
ipv4proto->AddAddress (ifIndex, ipv4Addr);

```

## DHCP assigned IPv4 addresses

DHCP is available in the `internet-apps` module. In order to use DHCP you have to have a `DhcpServer` application in a node (the DHC server node) and a `DhcpClient` application in each of the nodes. Note that it not necessary that all the nodes in a subnet use DHCP. Some nodes can have static addresses.

All the DHCP setup is performed though the `DhcpHelper` class. A complete example is in `src/internet-apps/examples/dhcp-example.cc`.

Further info about the DHCP functionalities can be found in the `internet-apps` model documentation.

## 17.2.2 Tracing in the IPv4 Stack

The internet stack provides a number of trace sources in its various protocol implementations. These trace sources can be hooked using your own custom trace code, or you can use our helper functions in some cases to arrange for tracing to be enabled.

### Tracing in ARP

ARP provides two trace hooks, one in the cache, and one in the layer three protocol. The trace accessor in the cache is given the name “Drop.” When a packet is transmitted over an interface that requires ARP, it is first queued for transmission in the ARP cache until the required MAC address is resolved. There are a number of retries that may be done trying to get the address, and if the maximum retry count is exceeded the packet in question is dropped by ARP. The single trace hook in the ARP cache is called,

- If an outbound packet is placed in the ARP cache pending address resolution and no resolution can be made within the maximum retry count, the outbound packet is dropped and this trace is fired;

A second trace hook lives in the ARP L3 protocol (also named “Drop”) and may be called for a number of reasons.

- If an ARP reply is received for an entry that is not waiting for a reply, the ARP reply packet is dropped and this trace is fired;
- If an ARP reply is received for a non-existent entry, the ARP reply packet is dropped and this trace is fired;
- If an ARP cache entry is in the DEAD state (has timed out) and an ARP reply packet is received, the reply packet is dropped and this trace is fired.
- Each ARP cache entry has a queue of pending packets. If the size of the queue is exceeded, the outbound packet is dropped and this trace is fired.

### Tracing in IPv4

The IPv4 layer three protocol provides three trace hooks. These are the “Tx” (`ns3::Ipv4L3Protocol::m_txTrace`), “Rx” (`ns3::Ipv4L3Protocol::m_rxTrace`) and “Drop” (`ns3::Ipv4L3Protocol::m_dropTrace`) trace sources.

The “Tx” trace is fired in a number of situations, all of which indicate that a given packet is about to be sent down to a given `ns3::Ipv4Interface`.

- In the case of a packet destined for the broadcast address, the `Ipv4InterfaceList` is iterated and for every interface that is up and can fragment the packet or has a large enough MTU to transmit the packet, the trace is hit. See `ns3::Ipv4L3Protocol::Send`.
- In the case of a packet that needs routing, the “Tx” trace may be fired just before a packet is sent to the interface appropriate to the default gateway. See `ns3::Ipv4L3Protocol::SendRealOut`.
- Also in the case of a packet that needs routing, the “Tx” trace may be fired just before a packet is sent to the outgoing interface appropriate to the discovered route. See `ns3::Ipv4L3Protocol::SendRealOut`.

The “Rx” trace is fired when a packet is passed from the device up to the `ns3::Ipv4L3Protocol::Receive` function.

- In the receive function, the `Ipv4InterfaceList` is iterated, and if the `Ipv4Interface` corresponding to the receiving device is found to be in the UP state, the trace is fired.

The “Drop” trace is fired in any case where the packet is dropped (in both the transmit and receive paths).

- In the `ns3::Ipv4Interface::Receive` function, the packet is dropped and the drop trace is hit if the interface corresponding to the receiving device is in the DOWN state.
- Also in the `ns3::Ipv4Interface::Receive` function, the packet is dropped and the drop trace is hit if the checksum is found to be bad.
- In `ns3::Ipv4L3Protocol::Send`, an outgoing packet bound for the broadcast address is dropped and the “Drop” trace is fired if the “don’t fragment” bit is set and fragmentation is available and required.
- Also in `ns3::Ipv4L3Protocol::Send`, an outgoing packet destined for the broadcast address is dropped and the “Drop” trace is hit if fragmentation is not available and is required (MTU < packet size).
- In the case of a broadcast address, an outgoing packet is cloned for each outgoing interface. If any of the interfaces is in the DOWN state, the “Drop” trace event fires with a reference to the copied packet.
- In the case of a packet requiring a route, an outgoing packet is dropped and the “Drop” trace event fires if no route to the remote host is found.
- In `ns3::Ipv4L3Protocol::SendRealOut`, an outgoing packet being routed is dropped and the “Drop” trace is fired if the “don’t fragment” bit is set and fragmentation is available and required.
- Also in `ns3::Ipv4L3Protocol::SendRealOut`, an outgoing packet being routed is dropped and the “Drop” trace is hit if fragmentation is not available and is required (MTU < packet size).
- An outgoing packet being routed is dropped and the “Drop” trace event fires if the required `Ipv4Interface` is in the DOWN state.
- If a packet is being forwarded, and the TTL is exceeded (see `ns3::Ipv4L3Protocol::DoForward`), the packet is dropped and the “Drop” trace event is fired.

### 17.2.3 Explicit Congestion Notification (ECN) bits

- In IPv4, ECN bits are the last 2 bits in TOS field and occupy 14th and 15th bits in the header.
- The IPv4 header class defines an `EcnType` enum with all four ECN codepoints (`ECN_NotECT`, `ECN_ECT1`, `ECN_ECT0`, `ECN_CE`) mentioned in RFC 3168, and also a setter and getter method to handle ECN values in the TOS field.

## 17.2.4 Ipv4QueueDiscItem

The traffic control sublayer in *ns-3* handles objects of class `QueueDiscItem` which are used to hold an `ns3::Packet` and an `ns3::Header`. This is done to facilitate the marking of packets for Explicit Congestion Notification. The `Mark ()` method is implemented in `Ipv4QueueDiscItem`. It returns `true` if marking the packet is successful, i.e., it successfully sets the CE bit in the IPv4 header. The `Mark ()` method will return `false`, however, if the IPv4 header indicates the `ECN_NotECT` codepoint.

## 17.2.5 RFC 6621 duplicate packet detection

To support mesh network protocols over broadcast-capable networks (e.g. Wi-Fi), it is useful to have support for duplicate packet detection and filtering, since nodes in a network may receive multiple copies of flooded multicast packets arriving on different paths. The `Ipv4L3Protocol` model in *ns-3* has a model for hash-based duplicate packet detection (DPD) based on Section 6.2.2 of (**RFC 6621**). The model, disabled by default, must be enabled by setting `EnableRFC6621` to `true`. A second attribute, `DuplicateExpire`, sets the expiration delay for erasing the cache entry of a packet in the duplicate cache; the delay value defaults to 1ms.

## 17.3 IPv6

This chapter describes the *ns-3* IPv6 model capabilities and limitations along with its usage and examples.

### 17.3.1 IPv6 model description

The IPv6 model is loosely patterned after the Linux implementation; the implementation is not complete as some features of IPv6 are not of much interest to simulation studies, and some features of IPv6 are simply not modeled yet in *ns-3*.

The base class `Ipv6` defines a generic API, while the class `Ipv6L3Protocol` is the actual class implementing the protocol. The actual classes used by the IPv6 stack are located mainly in the directory `src/internet`.

The implementation of IPv6 is contained in the following files:

```
src/internet/model/icmpv6-header.{cc,h}
src/internet/model/icmpv6-l4-protocol.{cc,h}
src/internet/model/ipv6.{cc,h}
src/internet/model/ipv6-address-generator.{cc,h}
src/internet/model/ipv6-autoconfigured-prefix.{cc,h}
src/internet/model/ipv6-end-point.{cc,h}
src/internet/model/ipv6-end-point-demux.{cc,h}
src/internet/model/ipv6-extension.{cc,h}
src/internet/model/ipv6-extension-demux.{cc,h}
src/internet/model/ipv6-extension-header.{cc,h}
src/internet/model/ipv6-header.{cc,h}
src/internet/model/ipv6-interface.{cc,h}
src/internet/model/ipv6-interface-address.{cc,h}
src/internet/model/ipv6-l3-protocol.{cc,h}
src/internet/model/ipv6-list-routing.{cc,h}
src/internet/model/ipv6-option.{cc,h}
src/internet/model/ipv6-option-demux.{cc,h}
src/internet/model/ipv6-option-header.{cc,h}
src/internet/model/ipv6-packet-info-tag.{cc,h}
src/internet/model/ipv6-pmtu-cache.{cc,h}
src/internet/model/ipv6-raw-socket-factory.{cc,h}
```

(continues on next page)

(continued from previous page)

```

src/internet/model/ipv6-raw-socket-factory-impl.{cc,h}
src/internet/model/ipv6-raw-socket-impl.{cc,h}
src/internet/model/ipv6-route.{cc,h}
src/internet/model/ipv6-routing-protocol.{cc,h}
src/internet/model/ipv6-routing-table-entry.{cc,h}
src/internet/model/ipv6-static-routing.{cc,h}
src/internet/model/ndisc-cache.{cc,h}
src/network/utils/inet6-socket-address.{cc,h}
src/network/utils/ipv6-address.{cc,h}

```

Also some helpers are involved with IPv6:

```

src/internet/helper/internet-stack-helper.{cc,h}
src/internet/helper/ipv6-address-helper.{cc,h}
src/internet/helper/ipv6-interface-container.{cc,h}
src/internet/helper/ipv6-list-routing-helper.{cc,h}
src/internet/helper/ipv6-routing-helper.{cc,h}
src/internet/helper/ipv6-static-routing-helper.{cc,h}

```

The model files can be roughly divided into:

- protocol models (e.g., ipv6, ipv6-l3-protocol, icmpv6-l4-protocol, etc.)
- routing models (i.e., anything with ‘routing’ in its name)
- sockets and interfaces (e.g., ipv6-raw-socket, ipv6-interface, ipv6-end-point, etc.)
- address-related things
- headers, option headers, extension headers, etc.
- accessory classes (e.g., ndisc-cache)

## 17.3.2 Usage

The following description is based on using the typical helpers found in the example code.

IPv6 does not need to be activated in a node. it is automatically added to the available protocols once the Internet Stack is installed.

In order to *not* install IPv6 along with IPv4, it is possible to use `ns3::InternetStackHelper` method `SetIpv6StackInstall` (*bool enable*) before installing the InternetStack in the nodes.

Note that to have an IPv6-only network (i.e., to not install the IPv4 stack in a node) one should use `ns3::InternetStackHelper` method `SetIpv4StackInstall` (*bool enable*) before the stack installation.

As an example, in the following code node 0 will have both IPv4 and IPv6, node 1 only IPv6 and node 2 only IPv4:

```

NodeContainer n;
n.Create (3);

InternetStackHelper internet;
InternetStackHelper internetV4only;
InternetStackHelper internetV6only;

internetV4only.SetIpv6StackInstall (false);
internetV6only.SetIpv4StackInstall (false);

```

(continues on next page)

```
internet.Install (n.Get (0));
internetV6only.Install (n.Get (1));
internetV4only.Install (n.Get (2));
```

## IPv6 addresses assignment

In order to use IPv6 on a network, the first thing to do is assigning IPv6 addresses.

Any IPv6-enabled *ns-3* node will have at least one `NetDevice`: the `ns3::LoopbackNetDevice`. The loopback device address is `::1`. All the other `NetDevices` will have one or more IPv6 addresses:

- One link-local address: `fe80::interface ID`, where `interface ID` is derived from the `NetDevice` MAC address.
- Zero or more global addresses, e.g., `2001:db8::1`.

Typically the first address on an interface will be the link-local one, with the global address(es) being the following ones.

IPv6 global addresses might be:

- manually assigned
- auto-generated

*ns-3* can use both methods, and it's quite important to understand the implications of both.

## Manually assigned IPv6 addresses

This is probably the easiest and most used method. As an example:

```
Ptr<Node> n0 = CreateObject<Node> ();
Ptr<Node> n1 = CreateObject<Node> ();
NodeContainer net (n0, n1);
CsmaHelper csma;
NetDeviceContainer ndc = csma.Install (net);

NS_LOG_INFO ("Assign IPv6 Addresses.");
Ipv6AddressHelper ipv6;
ipv6.SetBase (Ipv6Address ("2001:db8::"), Ipv6Prefix (64));
Ipv6InterfaceContainer ic = ipv6.Assign (ndc);
```

This method will add two global IPv6 addresses to the nodes. Note that, as usual for IPv6, all the nodes will also have a link-local address. Typically the first address on an interface will be the link-local one, with the global address(es) being the following ones.

Note that the global addresses will be derived from the MAC address. As a consequence, expect to have addresses similar to `2001:db8::200:ff:fe00:1`.

It is possible to repeat the above to assign more than one global address to a node. However, due to the `Ipv6AddressHelper` singleton nature, one should first assign all the addresses of a network, then change the network base (`SetBase`), then do a new assignment.

Alternatively, it is possible to assign a specific address to a node:

```

Ptr<Node> n0 = CreateObject<Node> ();
NodeContainer net (n0);
CsmaHelper csma;
NetDeviceContainer ndc = csma.Install (net);

NS_LOG_INFO ("Specifically Assign an IPv6 Address.");
Ipv6AddressHelper ipv6;
Ptr<NetDevice> device = ndc.Get (0);
Ptr<Node> node = device->GetNode ();
Ptr<Ipv6> ipv6proto = node->GetObject<Ipv6> ();
int32_t ifIndex = 0;
ifIndex = ipv6proto->GetInterfaceForDevice (device);
Ipv6InterfaceAddress ipv6Addr = Ipv6InterfaceAddress (Ipv6Address (
↪ "2001:db8:f00d:cafe::42"), Ipv6Prefix (64));
ipv6proto->AddAddress (ifIndex, ipv6Addr);

```

### Auto-generated IPv6 addresses

This is accomplished by relying on the RADVD protocol, implemented by the class `Radvd`. A helper class is available, which can be used to ease the most common tasks, e.g., setting up a prefix on an interface, if it is announced periodically, and if the router is the default router for that interface.

A fine grain configuration is possible through the `RadvdInterface` class, which allows to setup every parameter of the announced router advertisement on a given interface.

It is worth mentioning that the configurations must be set up before installing the application in the node.

Upon using this method, the nodes will acquire dynamically (i.e., during the simulation) one (or more) global address(es) according to the RADVD configuration. These addresses will be based on the RADVD announced prefix and the node's EUI-64.

Examples of RADVD use are shown in `examples/ipv6/radvd.cc` and `examples/ipv6/radvd-two-prefix.cc`.

### Random-generated IPv6 addresses

While IPv6 real nodes will use randomly generated addresses to protect privacy, *ns-3* does NOT have this capability. This feature hasn't been so far considered as interesting for simulation.

### Duplicate Address Detection (DAD)

Nodes will perform DAD (it can be disabled using an `Icmpv6L4Protocol` attribute). Upon receiving a DAD, however, nodes will not react to it. As is: DAD reaction is incomplete so far. The main reason relies on the missing random-generated address capability. Moreover, since *ns-3* nodes will usually be well-behaving, there shouldn't be any Duplicate Address. This might be changed in the future, so as to avoid issues with real-world integrated simulations.

### Explicit Congestion Notification (ECN) bits in IPv6

- In IPv6, ECN bits are the last 2 bits of the Traffic class and occupy 10th and 11th bit in the header.

- The IPv6 header class defines an `EcnType` enum with all four ECN codepoints (`ECN_NotECT`, `ECN_ECT1`, `ECN_ECT0`, `ECN_CE`) mentioned in RFC 3168, and also a setter and getter method to handle ECN values in the Traffic Class field.

### 17.3.3 Ipv6QueueDiscItem

The traffic control sublayer in *ns-3* handles objects of class `QueueDiscItem` which are used to hold an `ns3::Packet` and an `ns3::Header`. This is done to facilitate the marking of packets for Explicit Congestion Notification. The `Mark ()` method is implemented in `Ipv6QueueDiscItem`. It returns true if marking the packet is successful, i.e., it successfully sets the CE bit in the IPv6 header. The `Mark ()` method will return false, however, if the IPv6 header indicates the `ECN_NotECT` codepoint.

### Host and Router behaviour in IPv6 and ns-3

In IPv6 there is a clear distinction between *routers* and *hosts*. As one might expect, routers can forward packets from an interface to another interface, while hosts drop packets not directed to them.

Unfortunately, forwarding is not the only thing affected by this distinction, and forwarding itself might be fine-tuned, e.g., to forward packets incoming from an interface and drop packets from another interface.

In *ns-3* a node is configured to be an *host* by default. There are two main ways to change this behaviour:

- Using `ns3::Ipv6InterfaceContainer SetForwarding(uint32_t i, bool router)` where `i` is the interface index in the container.
- Changing the `ns3::Ipv6` attribute `IpForward`.

Either one can be used during the simulation.

A fine-grained setup can be accomplished by using `ns3::Ipv6Interface SetForwarding (bool forward)`; which allows to change the behaviour on a per-interface-basis.

Note that the node-wide configuration only serves as a convenient method to enable/disable the `ns3::Ipv6Interface` specific setting. An `Ipv6Interface` added to a node with forwarding enabled will be set to be forwarding as well. This is really important when a node has interfaces added during the simulation.

According to the `ns3::Ipv6Interface` forwarding state, the following happens:

- Forwarding OFF
  - The node will NOT reply to Router Solicitation
  - The node will react to Router Advertisement
  - The node will periodically send Router Solicitation
  - Routing protocols MUST DROP packets not directed to the node
- Forwarding ON
  - The node will reply to Router Solicitation
  - The node will NOT react to Router Advertisement
  - The node will NOT send Router Solicitation
  - Routing protocols MUST forward packets

The behaviour is matching `ip-sysctl.txt` (<http://www.kernel.org/doc/Documentation/networking/ip-sysctl.txt>) with the difference that it's not possible to override the behaviour using esoteric settings (e.g., forwarding but accept router advertisements, `accept_ra=2`, or forwarding but send router solicitations `forwarding=2`).



Consider carefully the implications of packet forwarding. As an example, a node will NOT send ICMPv6 PACKET\_TOO\_BIG messages from an interface with forwarding off. This is completely normal, as the Routing protocol will drop the packet before attempting to forward it.

## Helpers

Typically the helpers used in IPv6 setup are:

- `ns3::InternetStackHelper`
- `ns3::Ipv6AddressHelper`
- `ns3::Ipv6InterfaceContainer`

The use is almost identical to the corresponding IPv4 case, e.g.:

```
NodeContainer n;
n.Create (4);

NS_LOG_INFO ("Create IPv6 Internet Stack");
InternetStackHelper internetv6;
internetv6.Install (n);

NS_LOG_INFO ("Create channels.");
CsmaHelper csma;
NetDeviceContainer d = csma.Install (n);

NS_LOG_INFO ("Create networks and assign IPv6 Addresses.");
Ipv6AddressHelper ipv6;
ipv6.SetBase (Ipv6Address ("2001:db8::"), Ipv6Prefix (64));
Ipv6InterfaceContainer iic = ipv6.Assign (d);
```

Additionally, a common task is to enable forwarding on one of the nodes and to setup a default route toward it in the other nodes, e.g.:

```
iic.SetForwarding (0, true);
iic.SetDefaultRouteInAllNodes (0);
```

This will enable forwarding on the node 0 and will setup a default route in `ns3::Ipv6StaticRouting` on all the other nodes. Note that this requires that `Ipv6StaticRouting` is present in the nodes.

The IPv6 routing helpers enable the user to perform specific tasks on the particular routing algorithm and to print the routing tables.

## Attributes

Many classes in the *ns-3* IPv6 implementation contain attributes. The most useful ones are:

- `ns3::Ipv6`
- *IpForward*, boolean, default false. Globally enable or disable IP forwarding for all current and future IPv6 devices.
- *MtuDiscover*, boolean, default true. If disabled, every interface will have its MTU set to 1280 bytes.
- `ns3::Ipv6L3Protocol`
- *DefaultTtl*, `uint8_t`, default 64. The TTL value set by default on all outgoing packets generated on this node.
- *SendIcmpv6Redirect*, boolean, default true. Send the ICMPv6 Redirect when appropriate.

- `ns3::Icmpv6L4Protocol`
- *DAD*, boolean, default true. Always do DAD (Duplicate Address Detection) check.
- `ns3::NdiscCache`
- *UnresolvedQueueSize*, `uint32_t`, default 3. Size of the queue for packets pending an NA reply.

### Output

The IPv6 stack provides some useful trace sources:

- `ns3::Ipv6L3Protocol`
- *Tx*, Send IPv6 packet to outgoing interface.
- *Rx*, Receive IPv6 packet from incoming interface.
- *Drop*, Drop IPv6 packet.
- `ns3::Ipv6Extension`
- *Drop*, Drop IPv6 packet.

The latest trace source is generated when a packet contains an unknown option blocking its processing.

Mind that `ns3::NdiscCache` could drop packets as well, and they are not logged in a trace source (yet). This might generate some confusion in the sent/received packets counters.

### Advanced Usage

#### IPv6 maximum transmission unit (MTU) and fragmentation

*ns-3* NetDevices define the MTU according to the L2 simulated Device. IPv6 requires that the minimum MTU is 1280 bytes, so all NetDevices are required to support at least this MTU. This is the link-MTU.

In order to support different MTUs in a source-destination path, *ns-3* IPv6 model can perform fragmentation. This can be either triggered by receiving a packet bigger than the link-MTU from the L4 protocols (UDP, TCP, etc.), or by receiving an ICMPv6 PACKET\_TOO\_BIG message. The model mimics RFC 1981, with the following notable exceptions:

- L4 protocols are not informed of the Path MTU change
- TCP can not change its Segment Size according to the Path-MTU.

Both limitations are going to be removed in due time.

The Path-MTU cache is currently based on the source-destination IPv6 addresses. Further classifications (e.g., flow label) are possible but not yet implemented.

The Path-MTU default validity time is 10 minutes. After the cache entry expiration, the Path-MTU information is removed and the next packet will (eventually) trigger a new ICMPv6 PACKET\_TOO\_BIG message. Note that 1) this is consistent with the RFC specification and 2) L4 protocols are responsible for retransmitting the packets.

### Examples

The examples for IPv6 are in the directory `examples/ipv6`. These examples focus on the most interesting IPv6 peculiarities, such as fragmentation, redirect and so on.

Moreover, most TCP and UDP examples located in `examples/udp`, `examples/tcp`, etc. have a command-line option to use IPv6 instead of IPv4.

## Troubleshooting

There are just a few pitfalls to avoid while using *ns-3* IPv6.

### Routing loops

Since the only (so far) routing scheme available for IPv6 is `ns3::Ipv6StaticRouting`, default router have to be setup manually. When there are two or more routers in a network (e.g., node A and node B), avoid using the helper function `SetDefaultRouteInAllNodes` for more than one router.

The consequence would be to install a default route to B in A and a default route pointing to A in B, generating a loop.

### Global address leakage

Remember that addresses in IPv6 are *global* by definition. When using IPv6 with an emulation *ns-3* capability, avoid at all costs address leakage toward the global Internet. It is advisable to setup an external firewall to prevent leakage.

### 2001:DB8::/32 addresses

IPv6 standard (RFC 3849) defines the `2001:DB8::/32` address class for the *documentation*. This manual uses this convention. The addresses in this class are, however, only usable in a document, and routers should discard them.

## 17.3.4 Validation

The IPv6 protocols has not yet been extensively validated against real implementations. The actual tests involve mainly performing checks of the `.pcap` trace files with Wireshark, and the results are positive.

## 17.4 Routing overview

*ns-3* is intended to support traditional routing approaches and protocols, support ports of open source routing implementations, and facilitate research into unorthodox routing techniques. The overall routing architecture is described below in *Routing architecture*. Users who wish to just read about how to configure global routing for wired topologies can read *Global centralized routing*. Unicast routing protocols are described in *Unicast routing*. Multicast routing is documented in *Multicast routing*.

### 17.4.1 Routing architecture

*Overview of routing* shows the overall routing architecture for Ipv4. The key objects are `Ipv4L3Protocol`, `Ipv4RoutingProtocol(s)` (a class to which all routing/forwarding has been delegated from `Ipv4L3Protocol`), and `Ipv4Route(s)`.

`Ipv4L3Protocol` must have at least one `Ipv4RoutingProtocol` added to it at simulation setup time. This is done explicitly by calling `Ipv4::SetRoutingProtocol ()`.

The abstract base class `Ipv4RoutingProtocol ()` declares a minimal interface, consisting of two methods: `RouteOutput ()` and `RouteInput ()`. For packets traveling outbound from a host, the transport protocol will query `Ipv4` for the `Ipv4RoutingProtocol` object interface, and will request a route via `Ipv4RoutingProtocol::RouteOutput ()`. A `Ptr` to `Ipv4Route` object is returned. This is analogous to a `dst_cache` entry in Linux. The `Ipv4Route` is carried down to the

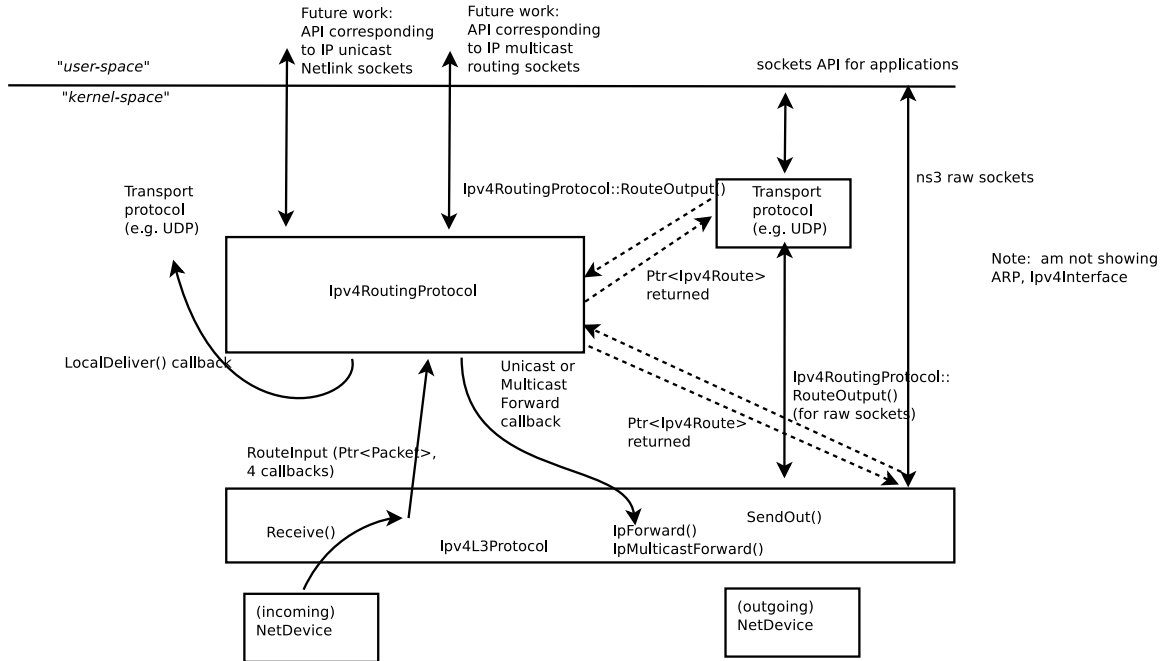

Fig. 3: Overview of routing

Ipv4L3Protocol to avoid a second lookup there. However, some cases (e.g. Ipv4 raw sockets) will require a call to `RouteOutput()` directly from `Ipv4L3Protocol`.

For packets received inbound for forwarding or delivery, the following steps occur. `Ipv4L3Protocol::Receive()` calls `Ipv4RoutingProtocol::RouteInput()`. This passes the packet ownership to the `Ipv4RoutingProtocol` object. There are four callbacks associated with this call:

- LocalDeliver
- UnicastForward
- MulticastForward
- Error

The `Ipv4RoutingProtocol` must eventually call one of these callbacks for each packet that it takes responsibility for. This is basically how the input routing process works in Linux.

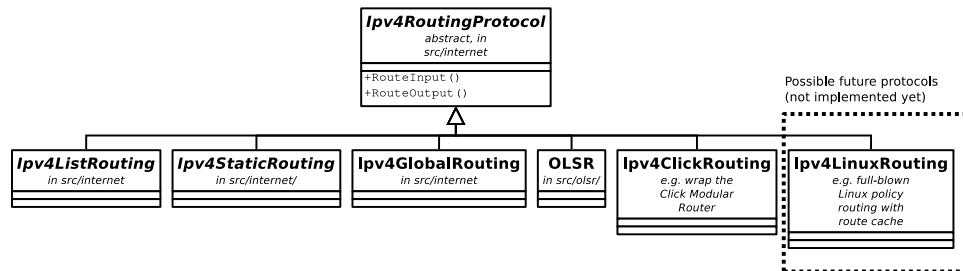

Fig. 4: Ipv4Routing specialization.

This overall architecture is designed to support different routing approaches, including (in the future) a Linux-like policy-based routing implementation, proactive and on-demand routing protocols, and simple routing protocols for when the simulation user does not really care about routing.

*Ipv4Routing specialization.* illustrates how multiple routing protocols derive from this base class. A class `Ipv4ListRouting` (implementation class `Ipv4ListRoutingImpl`) provides the existing list routing approach in *ns-3*. Its API is the same as base class `Ipv4Routing` except for the ability to add multiple prioritized routing protocols (`Ipv4ListRouting::AddRoutingProtocol()`, `Ipv4ListRouting::GetRoutingProtocol()`).

The details of these routing protocols are described below in *Unicast routing*. For now, we will first start with a basic unicast routing capability that is intended to globally build routing tables at simulation time  $t=0$  for simulation users who do not care about dynamic routing.

## 17.4.2 Unicast routing

The following unicast routing protocols are defined for IPv4 and IPv6:

- classes `Ipv4ListRouting` and `Ipv6ListRouting` (used to store a prioritized list of routing protocols)
- classes `Ipv4StaticRouting` and `Ipv6StaticRouting` (covering both unicast and multicast)
- class `Ipv4GlobalRouting` (used to store routes computed by the global route manager, if that is used)
- class `Ipv4NixVectorRouting` (a more efficient version of global routing that stores source routes in a packet header field)
- class `Rip` - the IPv4 RIPv2 protocol (**RFC 2453**)
- class `RipNg` - the IPv6 RIPng protocol (**RFC 2080**)
- IPv4 Optimized Link State Routing (OLSR) (a MANET protocol defined in **RFC 3626**)
- IPv4 Ad Hoc On Demand Distance Vector (AODV) (a MANET protocol defined in **RFC 3561**)
- IPv4 Destination Sequenced Distance Vector (DSDV) (a MANET protocol)
- IPv4 Dynamic Source Routing (DSR) (a MANET protocol)

In the future, this architecture should also allow someone to implement a Linux-like implementation with routing cache, or a Click modular router, but those are out of scope for now.

### Ipv[4,6]ListRouting

This section describes the current default *ns-3* `Ipv[4,6]RoutingProtocol`. Typically, multiple routing protocols are supported in user space and coordinate to write a single forwarding table in the kernel. Presently in *ns-3*, the implementation instead allows for multiple routing protocols to build/keep their own routing state, and the IP implementation will query each one of these routing protocols (in some order determined by the simulation author) until a route is found.

We chose this approach because it may better facilitate the integration of disparate routing approaches that may be difficult to coordinate the writing to a single table, approaches where more information than destination IP address (e.g., source routing) is used to determine the next hop, and on-demand routing approaches where packets must be cached.

### Ipv[4,6]ListRouting::AddRoutingProtocol

Classes `Ipv4ListRouting` and `Ipv6ListRouting` provides a pure virtual function declaration for the method that allows one to add a routing protocol:

```
void AddRoutingProtocol (Ptr<Ipv4RoutingProtocol> routingProtocol,
                        int16_t priority);
```

(continues on next page)

(continued from previous page)

```
void AddRoutingProtocol (Ptr<Ipv6RoutingProtocol> routingProtocol,  
                        int16_t priority);
```

These methods are implemented respectively by class `Ipv4ListRoutingImpl` and by class `Ipv6ListRoutingImpl` in the `internet` module.

The priority variable above governs the priority in which the routing protocols are inserted. Notice that it is a signed int. By default in *ns-3*, the helper classes will instantiate a `Ipv[4,6]ListRoutingImpl` object, and add to it an `Ipv[4,6]StaticRoutingImpl` object at priority zero. Internally, a list of `Ipv[4,6]RoutingProtocols` is stored, and and the routing protocols are each consulted in decreasing order of priority to see whether a match is found. Therefore, if you want your `Ipv4RoutingProtocol` to have priority lower than the static routing, insert it with priority less than 0; e.g.:

```
Ptr<MyRoutingProtocol> myRoutingProto = CreateObject<MyRoutingProtocol> ();  
listRoutingPtr->AddRoutingProtocol (myRoutingProto, -10);
```

Upon calls to `RouteOutput()` or `RouteInput()`, the list routing object will search the list of routing protocols, in priority order, until a route is found. Such routing protocol will invoke the appropriate callback and no further routing protocols will be searched.

## Global centralized routing

Global centralized routing is sometimes called “God” routing; it is a special implementation that walks the simulation topology and runs a shortest path algorithm, and populates each node’s routing tables. No actual protocol overhead (on the simulated links) is incurred with this approach. It does have a few constraints:

- **Wired only:** It is not intended for use in wireless networks.
- **Unicast only:** It does not do multicast.
- **Scalability:** Some users of this on large topologies (e.g. 1000 nodes) have noticed that the current implementation is not very scalable. The global centralized routing will be modified in the future to reduce computations and runtime performance.

Presently, global centralized IPv4 unicast routing over both point-to-point and shared (CSMA) links is supported.

By default, when using the *ns-3* helper API and the default `InternetStackHelper`, global routing capability will be added to the node, and global routing will be inserted as a routing protocol with lower priority than the static routes (i.e., users can insert routes via `Ipv4StaticRouting` API and they will take precedence over routes found by global routing).

## Global Unicast Routing API

The public API is very minimal. User scripts include the following:

```
#include "ns3/internet-module.h"
```

If the default `InternetStackHelper` is used, then an instance of global routing will be aggregated to each node. After IP addresses are configured, the following function call will cause all of the nodes that have an `Ipv4` interface to receive forwarding tables entered automatically by the `GlobalRouteManager`:

```
Ipv4GlobalRoutingHelper::PopulateRoutingTables ();
```

*Note:* A reminder that the `wifi` `NetDevice` will work but does not take any wireless effects into account. For wireless, we recommend OLSR dynamic routing described below.

It is possible to call this function again in the midst of a simulation using the following additional public function:

```
Ipv4GlobalRoutingHelper::RecomputeRoutingTables ();
```

which flushes the old tables, queries the nodes for new interface information, and rebuilds the routes.

For instance, this scheduling call will cause the tables to be rebuilt at time 5 seconds:

```
Simulator::Schedule (Seconds (5),
    &Ipv4GlobalRoutingHelper::RecomputeRoutingTables);
```

There are two attributes that govern the behavior. The first is `Ipv4GlobalRouting::RandomEcmpRouting`. If set to true, packets are randomly routed across equal-cost multipath routes. If set to false (default), only one route is consistently used. The second is `Ipv4GlobalRouting::RespondToInterfaceEvents`. If set to true, dynamically recompute the global routes upon Interface notification events (up/down, or add/remove address). If set to false (default), routing may break unless the user manually calls `RecomputeRoutingTables()` after such events. The default is set to false to preserve legacy *ns-3* program behavior.

## Global Routing Implementation

This section is for those readers who care about how this is implemented. A singleton object (`GlobalRouteManager`) is responsible for populating the static routes on each node, using the public IPv4 API of that node. It queries each node in the topology for a “globalRouter” interface. If found, it uses the API of that interface to obtain a “link state advertisement (LSA)” for the router. Link State Advertisements are used in OSPF routing, and we follow their formatting.

It is important to note that all of these computations are done before packets are flowing in the network. In particular, there are no overhead or control packets being exchanged when using this implementation. Instead, this global route manager just walks the list of nodes to build the necessary information and configure each node’s routing table.

The `GlobalRouteManager` populates a link state database with LSAs gathered from the entire topology. Then, for each router in the topology, the `GlobalRouteManager` executes the OSPF shortest path first (SPF) computation on the database, and populates the routing tables on each node.

The quagga (<http://www.quagga.net>) OSPF implementation was used as the basis for the routing computation logic. One benefit of following an existing OSPF SPF implementation is that OSPF already has defined link state advertisements for all common types of network links:

- point-to-point (serial links)
- point-to-multipoint (Frame Relay, ad hoc wireless)
- non-broadcast multiple access (ATM)
- broadcast (Ethernet)

Therefore, we think that enabling these other link types will be more straightforward now that the underlying OSPF SPF framework is in place.

Presently, we can handle IPv4 point-to-point, numbered links, as well as shared broadcast (CSMA) links. Equal-cost multipath is also supported. Although wireless link types are supported by the implementation, note that due to the nature of this implementation, any channel effects will not be considered and the routing tables will assume that every node on the same shared channel is reachable from every other node (i.e. it will be treated like a broadcast CSMA link).

The `GlobalRouteManager` first walks the list of nodes and aggregates a `GlobalRouter` interface to each one as follows:

```
typedef std::vector < Ptr<Node> >::iterator Iterator;
for (Iterator i = NodeList::Begin (); i != NodeList::End (); i++)
{
```

(continues on next page)

(continued from previous page)

```
Ptr<Node> node = *i;
Ptr<GlobalRouter> globalRouter = CreateObject<GlobalRouter> (node);
node->AggregateObject (globalRouter);
}
```

This interface is later queried and used to generate a Link State Advertisement for each router, and this link state database is fed into the OSPF shortest path computation logic. The Ipv4 API is finally used to populate the routes themselves.

## RIP and RIPng

The RIPv2 protocol for IPv4 is described in the [RFC 2453](#), and it consolidates a number of improvements over the base protocol defined in [RFC 1058](#).

This IPv6 routing protocol ([RFC 2080](#)) is the evolution of the well-known RIPv1 (see [RFC 1058](#) and [RFC 1723](#)) routing protocol for IPv4.

The protocols are very simple, and are normally suitable for flat, simple network topologies.

RIPv1, RIPv2, and RIPng have the very same goals and limitations. In particular, RIP considers any route with a metric equal or greater than 16 as unreachable. As a consequence, the maximum number of hops is the network must be less than 15 (the number of routers is not set). Users are encouraged to read [RFC 2080](#) and [RFC 1058](#) to fully understand RIP behaviour and limitations.

## Routing convergence

RIP uses a Distance-Vector algorithm, and routes are updated according to the Bellman-Ford algorithm (sometimes known as Ford-Fulkerson algorithm). The algorithm has a convergence time of  $O(|V|*|E|)$  where  $|V|$  and  $|E|$  are the number of vertices (routers) and edges (links) respectively. It should be stressed that the convergence time is the number of steps in the algorithm, and each step is triggered by a message. Since Triggered Updates (i.e., when a route is changed) have a 1-5 seconds cooldown, the topology can require some time to be stabilized.

Users should be aware that, during routing tables construction, the routers might drop packets. Data traffic should be sent only after a time long enough to allow RIP to build the network topology. Usually 80 seconds should be enough to have a suboptimal (but working) routing setup. This includes the time needed to propagate the routes to the most distant router (16 hops) with Triggered Updates.

If the network topology is changed (e.g., a link is broken), the recovery time might be quite high, and it might be even higher than the initial setup time. Moreover, the network topology recovery is affected by the Split Horizing strategy.

The `examples` `examples/routing/ripng-simple-network.cc` and `examples/routing/rip-simple-network.cc` shows both the network setup and network recovery phases.

## Split Horizing

Split Horizon is a strategy to prevent routing instability. Three options are possible:

- No Split Horizon
- Split Horizon
- Poison Reverse



In the first case, routes are advertised on all the router's interfaces. In the second case, routers will not advertise a route on the interface from which it was learned. Poison Reverse will advertise the route on the interface from which it was learned, but with a metric of 16 (infinity). For a full analysis of the three techniques, see [RFC 1058](#), section 2.2.

The examples are based on the network topology described in the RFC, but it does not show the effect described there.

The reason are the Triggered Updates, together with the fact that when a router invalidates a route, it will immediately propagate the route unreachability, thus preventing most of the issues described in the RFC.

However, with complex topologies, it is still possible to have route instability phenomena similar to the one described in the RFC after a link failure. As a consequence, all the considerations about Split Horizon remains valid.

## Default routes

RIP protocol should be installed *only* on routers. As a consequence, nodes will not know what is the default router.

To overcome this limitation, users should either install the default route manually (e.g., by resorting to `Ipv4StaticRouting` or `Ipv6StaticRouting`), or by using RADVD (in case of IPv6). RADVD is available in *ns-3* in the Applications module, and it is strongly suggested.

## Protocol parameters and options

The RIP *ns-3* implementations allow to change all the timers associated with route updates and routes lifetime.

Moreover, users can change the interface metrics on a per-node basis.

The type of Split Horizing (to avoid routes back-propagation) can be selected on a per-node basis, with the choices being “no split horizon”, “split horizon” and “poison reverse”. See [RFC 2080](#) for further details, and [RFC 1058](#) for a complete discussion on the split horizing strategies.

Moreover, it is possible to use a non-standard value for Link Down Value (i.e., the value after which a link is considered down). The default is value is 16.

## Limitations

There is no support for the Next Hop option ([RFC 2080](#), Section 2.1.1). The Next Hop option is useful when RIP is not being run on all of the routers on a network. Support for this option may be considered in the future.

There is no support for CIDR prefix aggregation. As a result, both routing tables and route advertisements may be larger than necessary. Prefix aggregation may be added in the future.

## Other routing protocols

Other routing protocols documentation can be found under the respective modules sections, e.g.:

- AODV
- Click
- DSDV
- DSR
- NixVectorRouting
- OLSR
- etc.

### 17.4.3 Multicast routing

The following function is used to add a static multicast route to a node:

```
void
Ipv4StaticRouting::AddMulticastRoute (Ipv4Address origin,
                                       Ipv4Address group,
                                       uint32_t inputInterface,
                                       std::vector<uint32_t> outputInterfaces);
```

A multicast route must specify an origin IP address, a multicast group and an input network interface index as conditions and provide a vector of output network interface indices over which packets matching the conditions are sent.

Typically there are two main types of multicast routes:

- Routes used during forwarding, and
- Routes used in the originator node.

In the first case all the conditions must be explicitly provided.

In the second case, the route is equivalent to a unicast route, and must be added through *Ipv4StaticRouting::AddHostRouteTo*.

Another command sets the default multicast route:

```
void
Ipv4StaticRouting::SetDefaultMulticastRoute (uint32_t outputInterface);
```

This is the multicast equivalent of the unicast version *SetDefaultRoute*. We tell the routing system what to do in the case where a specific route to a destination multicast group is not found. The system forwards packets out the specified interface in the hope that “something out there” knows better how to route the packet. This method is only used in initially sending packets off of a host. The default multicast route is not consulted during forwarding – exact routes must be specified using *AddMulticastRoute* for that case.

Since we’re basically sending packets to some entity we think may know better what to do, we don’t pay attention to “subtleties” like origin address, nor do we worry about forwarding out multiple interfaces. If the default multicast route is set, it is returned as the selected route from *LookupStatic* irrespective of origin or multicast group if another specific route is not found.

Finally, a number of additional functions are provided to fetch and remove multicast routes:

```
uint32_t GetNMulticastRoutes (void) const;

Ipv4MulticastRoute *GetMulticastRoute (uint32_t i) const;

Ipv4MulticastRoute *GetDefaultMulticastRoute (void) const;

bool RemoveMulticastRoute (Ipv4Address origin,
                           Ipv4Address group,
                           uint32_t inputInterface);

void RemoveMulticastRoute (uint32_t index);
```

## 17.5 TCP models in ns-3

This chapter describes the TCP models available in *ns-3*.

## 17.5.1 Overview of support for TCP

*ns-3* was written to support multiple TCP implementations. The implementations inherit from a few common header classes in the `src/network` directory, so that user code can swap out implementations with minimal changes to the scripts.

There are three important abstract base classes:

- class `TcpSocket`: This is defined in `src/internet/model/tcp-socket.{cc,h}`. This class exists for hosting `TcpSocket` attributes that can be reused across different implementations. For instance, the attribute `InitialCwnd` can be used for any of the implementations that derive from class `TcpSocket`.
- class `TcpSocketFactory`: This is used by the layer-4 protocol instance to create TCP sockets of the right type.
- class `TcpCongestionOps`: This supports different variants of congestion control— a key topic of simulation-based TCP research.

There are presently two active and one legacy implementations of TCP available for *ns-3*.

- a natively implemented TCP for *ns-3*
- support for kernel implementations via [Direct Code Execution \(DCE\)](#)
- (legacy) support for kernel implementations for the [Network Simulation Cradle \(NSC\)](#)

NSC is no longer actively supported; it requires use of `gcc-5` or `gcc-4.9`, and only covers up to Linux kernel version 2.6.29.

Direct Code Execution is also limited in its support for newer kernels; at present, only Linux kernel 4.4 is supported. However, the TCP implementations in kernel 4.4 can still be used for *ns-3* validation or for specialized simulation use cases.

It should also be mentioned that various ways of combining virtual machines with *ns-3* makes available also some additional TCP implementations, but those are out of scope for this chapter.

## 17.5.2 ns-3 TCP

In brief, the native *ns-3* TCP model supports a full bidirectional TCP with connection setup and close logic. Several congestion control algorithms are supported, with NewReno the default, and CUBIC, Westwood, Hybla, HighSpeed, Vegas, Scalable, Veno, Binary Increase Congestion Control (BIC), Yet Another HighSpeed TCP (YeAH), Illinois, H-TCP, Low Extra Delay Background Transport (LEDBAT), TCP Low Priority (TCP-LP) and Data Center TCP (DCTCP) also supported. The model also supports Selective Acknowledgements (SACK), Proportional Rate Reduction (PRR) and Explicit Congestion Notification (ECN). Multipath-TCP is not yet supported in the *ns-3* releases.

### Model history

Until the *ns-3.10* release, *ns-3* contained a port of the TCP model from [GTNetS](#), developed initially by George Riley and ported to *ns-3* by Raj Bhattacharjea. This implementation was substantially rewritten by Adriam Tam for *ns-3.10*. In 2015, the TCP module was redesigned in order to create a better environment for creating and carrying out automated tests. One of the main changes involves congestion control algorithms, and how they are implemented.

Before the *ns-3.25* release, a congestion control was considered as a stand-alone TCP through an inheritance relation: each congestion control (e.g. `TcpNewReno`) was a subclass of `TcpSocketBase`, reimplementing some inherited methods. The architecture was redone to avoid this inheritance, by making each congestion control a separate class, and defining an interface to exchange important data between `TcpSocketBase` and the congestion modules. The Linux `tcp_congestion_ops` interface was used as the design reference.

Along with congestion control, Fast Retransmit and Fast Recovery algorithms have been modified; in previous releases, these algorithms were delegated to `TcpSocketBase` subclasses. Starting from *ns-3.25*, they have been merged

inside `TcpSocketBase`. In future releases, they can be extracted as separate modules, following the congestion control design.

As of the ns-3.31 release, the default initial window was set to 10 segments (in previous releases, it was set to 1 segment). This aligns with current Linux default, and is discussed further in [RFC 6928](#).

In the ns-3.32 release, the default recovery algorithm was set to Proportional Rate Reduction (PRR) from the classic ack-clocked Fast Recovery algorithm.

### Acknowledgments

As mentioned above, ns-3 TCP has had multiple authors and maintainers over the years. Several publications exist on aspects of ns-3 TCP, and users of ns-3 TCP are requested to cite one of the applicable papers when publishing new work.

A general reference on the current architecture is found in the following paper:

- Maurizio Casoni, Natale Patriciello, Next-generation TCP for ns-3 simulator, *Simulation Modelling Practice and Theory*, Volume 66, 2016, Pages 81-93. (<http://www.sciencedirect.com/science/article/pii/S1569190X15300939>)

For an academic peer-reviewed paper on the SACK implementation in ns-3, please refer to:

- Natale Patriciello. 2017. A SACK-based Conservative Loss Recovery Algorithm for ns-3 TCP: a Linux-inspired Proposal. In *Proceedings of the Workshop on ns-3 (WNS3 '17)*. ACM, New York, NY, USA, 1-8. (<https://dl.acm.org/citation.cfm?id=3067666>)

### Usage

In many cases, usage of TCP is set at the application layer by telling the ns-3 application which kind of socket factory to use.

Using the helper functions defined in `src/applications/helper` and `src/network/helper`, here is how one would create a TCP receiver:

```
// Create a packet sink on the star "hub" to receive these packets
uint16_t port = 50000;
Address sinkLocalAddress(InetSocketAddress(Ipv4Address::GetAny(), port));
PacketSinkHelper sinkHelper("ns3::TcpSocketFactory", sinkLocalAddress);
ApplicationContainer sinkApp = sinkHelper.Install(serverNode);
sinkApp.Start(Seconds(1.0));
sinkApp.Stop(Seconds(10.0));
```

Similarly, the below snippet configures `OnOffApplication` traffic source to use TCP:

```
// Create the OnOff applications to send TCP to the server
OnOffHelper clientHelper("ns3::TcpSocketFactory", Address());
```

The careful reader will note above that we have specified the `TypeId` of an abstract base class `TcpSocketFactory`. How does the script tell ns-3 that it wants the native ns-3 TCP vs. some other one? Well, when internet stacks are added to the node, the default TCP implementation that is aggregated to the node is the ns-3 TCP. This can be overridden as we show below when using Network Simulation Cradle. So, by default, when using the ns-3 helper API, the TCP that is aggregated to nodes with an Internet stack is the native ns-3 TCP.

To configure behavior of TCP, a number of parameters are exported through the ns-3 attribute system. These are documented in the [Doxygen](#) for class `TcpSocket`. For example, the maximum segment size is a settable attribute.

To set the default socket type before any internet stack-related objects are created, one may put the following statement at the top of the simulation program:

```
Config::SetDefault ("ns3::TcpL4Protocol::SocketType", StringValue ("ns3::TcpNewReno
↪"));
```

For users who wish to have a pointer to the actual socket (so that socket operations like Bind(), setting socket options, etc. can be done on a per-socket basis), Tcp sockets can be created by using the Socket::CreateSocket() method. The TypeId passed to CreateSocket() must be of type ns3::SocketFactory, so configuring the underlying socket type must be done by twiddling the attribute associated with the underlying TcpL4Protocol object. The easiest way to get at this would be through the attribute configuration system. In the below example, the Node container “n0n1” is accessed to get the zeroth element, and a socket is created on this node:

```
// Create and bind the socket...
TypeId tid = TypeId::LookupByName ("ns3::TcpNewReno");
Config::Set ("/NodeList/*/ns3::TcpL4Protocol/SocketType", TypeIdValue (tid));
Ptr<Socket> localSocket =
    Socket::CreateSocket (n0n1.Get (0), TcpSocketFactory::GetTypeId ());
```

Above, the “\*” wild card for node number is passed to the attribute configuration system, so that all future sockets on all nodes are set to NewReno, not just on node ‘n0n1.Get (0)’. If one wants to limit it to just the specified node, one would have to do something like:

```
// Create and bind the socket...
TypeId tid = TypeId::LookupByName ("ns3::TcpNewReno");
std::stringstream nodeId;
nodeId << n0n1.Get (0)->GetId ();
std::string specificNode = "/NodeList/" + nodeId.str () + "/ns3::TcpL4Protocol/
↪SocketType";
Config::Set (specificNode, TypeIdValue (tid));
Ptr<Socket> localSocket =
    Socket::CreateSocket (n0n1.Get (0), TcpSocketFactory::GetTypeId ());
```

Once a TCP socket is created, one will want to follow conventional socket logic and either connect() and send() (for a TCP client) or bind(), listen(), and accept() (for a TCP server). Please note that applications usually create the sockets they use automatically, and so is not straightforward to connect directly to them using pointers. Please refer to the source code of your preferred application to discover how and when it creates the socket.

## TCP Socket interaction and interface with Application layer

In the following there is an analysis on the public interface of the TCP socket, and how it can be used to interact with the socket itself. An analysis of the callback fired by the socket is also carried out. Please note that, for the sake of clarity, we will use the terminology “Sender” and “Receiver” to clearly divide the functionality of the socket. However, in TCP these two roles can be applied at the same time (i.e. a socket could be a sender and a receiver at the same time): our distinction does not lose generality, since the following definition can be applied to both sockets in case of full-duplex mode.

---

### TCP state machine (for commodity use)

In ns-3 we are fully compliant with the state machine depicted in Figure *TCP State machine*.

---

### Public interface for receivers (e.g. servers receiving data)

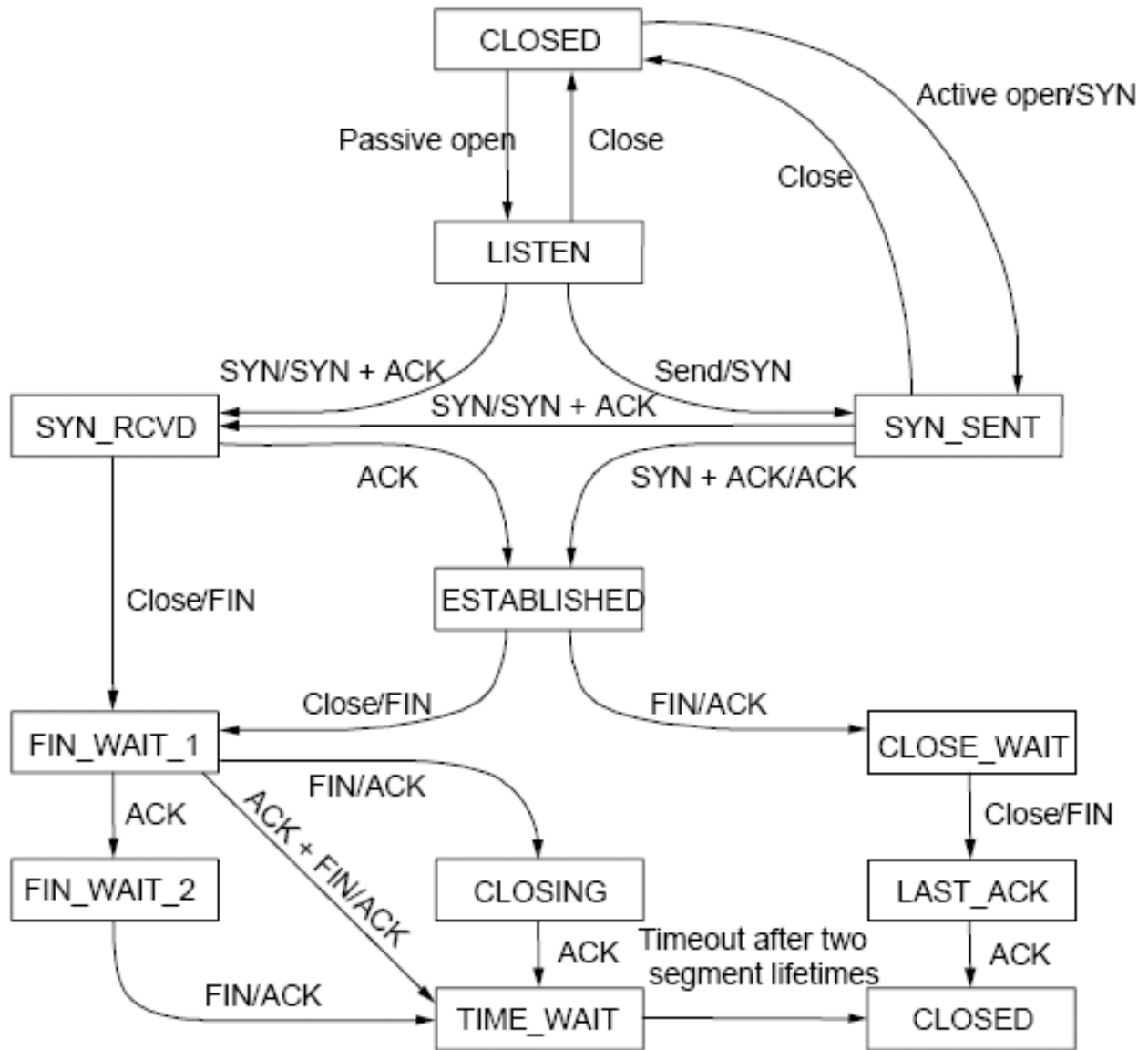

Fig. 5: TCP State machine

**Bind()** Bind the socket to an address, or to a general endpoint. A general endpoint is an endpoint with an ephemeral port allocation (that is, a random port allocation) on the 0.0.0.0 IP address. For instance, in current applications, data senders usually binds automatically after a *Connect()* over a random port. Consequently, the connection will start from this random port towards the well-defined port of the receiver. The IP 0.0.0.0 is then translated by lower layers into the real IP of the device.

**Bind6()** Same as *Bind()*, but for IPv6.

**BindToNetDevice()** Bind the socket to the specified NetDevice, creating a general endpoint.

**Listen()** Listen on the endpoint for an incoming connection. Please note that this function can be called only in the TCP CLOSED state, and transit in the LISTEN state. When an incoming request for connection is detected (i.e. the other peer invoked *Connect()*) the application will be signaled with the callback *NotifyConnectionRequest* (set in *SetAcceptCallback()* beforehand). If the connection is accepted (the default behavior, when the associated callback is a null one) the Socket will fork itself, i.e. a new socket is created to handle the incoming data/connection, in the state SYN\_RCVD. Please note that this newly created socket is not connected anymore to the callbacks on the “father” socket (e.g. *DataSent*, *Recv*); the pointer of the newly created socket is provided in the Callback *NotifyNewConnectionCreated* (set beforehand in *SetAcceptCallback*), and should be used to connect new callbacks to interesting events (e.g. *Recv* callback). After receiving the ACK of the SYN-ACK, the socket will set the congestion control, move into ESTABLISHED state, and then notify the application with *NotifyNewConnectionCreated*.

**ShutdownSend()** Signal a termination of send, or in other words prevents data from being added to the buffer. After this call, if buffer is already empty, the socket will send a FIN, otherwise FIN will go when buffer empties. Please note that this is useful only for modeling “Sink” applications. If you have data to transmit, please refer to the *Send()* / *Close()* combination of API.

**GetRxAvailable()** Get the amount of data that could be returned by the Socket in one or multiple call to *Recv* or *RecvFrom*. Please use the Attribute system to configure the maximum available space on the receiver buffer (property “RcvBufSize”).

**Recv()** Grab data from the TCP socket. Please remember that TCP is a stream socket, and it is allowed to concatenate multiple packets into bigger ones. If no data is present (i.e. *GetRxAvailable* returns 0) an empty packet is returned. Set the callback *RecvCallback* through *SetRecvCallback()* in order to have the application automatically notified when some data is ready to be read. It’s important to connect that callback to the newly created socket in case of forks.

**RecvFrom()** Same as *Recv*, but with the source address as parameter.

### Public interface for senders (e.g. clients uploading data)

**Connect()** Set the remote endpoint, and try to connect to it. The local endpoint should be set before this call, or otherwise an ephemeral one will be created. The TCP then will be in the SYN\_SENT state. If a SYN-ACK is received, the TCP will setup the congestion control, and then call the callback *ConnectionSucceeded*.

**GetTxAvailable()** Return the amount of data that can be stored in the TCP Tx buffer. Set this property through the Attribute system (“SndBufSize”).

**Send()** Send the data into the TCP Tx buffer. From there, the TCP rules will decide if, and when, this data will be transmitted. Please note that, if the tx buffer has enough data to fill the congestion (or the receiver) window, dynamically varying the rate at which data is injected in the TCP buffer does not have any noticeable effect on the amount of data transmitted on the wire, that will continue to be decided by the TCP rules.

**SendTo()** Same as *Send()*.

**Close()** Terminate the local side of the connection, by sending a FIN (after all data in the tx buffer has been transmitted). This does not prevent the socket in receiving data, and employing retransmit mechanism if losses are detected. If the application calls *Close()* with unread data in its rx buffer, the socket will send a reset. If the socket

is in the state SYN\_SENT, CLOSING, LISTEN, FIN\_WAIT\_2, or LAST\_ACK, after that call the application will be notified with *NotifyNormalClose()*. In other cases, the notification is delayed (see *NotifyNormalClose()*).

---

### Public callbacks

These callbacks are called by the TCP socket to notify the application of interesting events. We will refer to these with the protected name used in socket.h, but we will provide the API function to set the pointers to these callback as well.

**NotifyConnectionSucceeded: SetConnectCallback, 1st argument** Called in the SYN\_SENT state, before moving to ESTABLISHED. In other words, we have sent the SYN, and we received the SYN-ACK: the socket prepares the sequence numbers, sends the ACK for the SYN-ACK, tries to send out more data (in another segment) and then invokes this callback. After this callback, it invokes the NotifySend callback.

**NotifyConnectionFailed: SetConnectCallback, 2nd argument** Called after the SYN retransmission count goes to 0. SYN packet is lost multiple times, and the socket gives up.

**NotifyNormalClose: SetCloseCallbacks, 1st argument** A normal close is invoked. A rare case is when we receive an RST segment (or a segment with bad flags) in normal states. All other cases are: - The application tries to *Connect()* over an already connected socket - Received an ACK for the FIN sent, with or without the FIN bit set (we are in LAST\_ACK) - The socket reaches the maximum amount of retries in retransmitting the SYN (\*) - We receive a timeout in the LAST\_ACK state - Upon entering the TIME\_WAIT state, before waiting the 2\*Maximum Segment Lifetime seconds to finally deallocate the socket.

**NotifyErrorClose: SetCloseCallbacks, 2nd argument** Invoked when we send an RST segment (for whatever reason) or we reached the maximum amount of data retries.

**NotifyConnectionRequest: SetAcceptCallback, 1st argument** Invoked in the LISTEN state, when we receive a SYN. The return value indicates if the socket should accept the connection (return true) or should ignore it (return false).

**NotifyNewConnectionCreated: SetAcceptCallback, 2nd argument** Invoked when from SYN\_RCVD the socket passes to ESTABLISHED, and after setting up the congestion control, the sequence numbers, and processing the incoming ACK. If there is some space in the buffer, *NotifySend* is called shortly after this callback. The Socket pointer, passed with this callback, is the newly created socket, after a Fork().

**NotifyDataSent: SetDataSentCallback** The Socket notifies the application that some bytes have been transmitted on the IP level. These bytes could still be lost in the node (traffic control layer) or in the network.

**NotifySend: SetSendCallback** Invoked if there is some space in the tx buffer when entering the ESTABLISHED state (e.g. after the ACK for SYN-ACK is received), after the connection succeeds (e.g. after the SYN-ACK is received) and after each new ACK (i.e. that advances SND.UNA).

**NotifyDataRecv: SetRecvCallback** Called when in the receiver buffer there are in-order bytes, and when in FIN\_WAIT\_1 or FIN\_WAIT\_2 the socket receive a in-sequence FIN (that can carry data).

### Congestion Control Algorithms

Here follows a list of supported TCP congestion control algorithms. For an academic paper on many of these congestion control algorithms, see <http://dl.acm.org/citation.cfm?id=2756518>.

### NewReno

NewReno algorithm introduces partial ACKs inside the well-established Reno algorithm. This and other modifications are described in RFC 6582. We have two possible congestion window increment strategy: slow start and congestion avoidance. Taken from RFC 5681:



During slow start, a TCP increments `cwnd` by at most `SMSS` bytes for each ACK received that cumulatively acknowledges new data. Slow start ends when `cwnd` exceeds `ssthresh` (or, optionally, when it reaches it, as noted above) or when congestion is observed. While traditionally TCP implementations have increased `cwnd` by precisely `SMSS` bytes upon receipt of an ACK covering new data, we RECOMMEND that TCP implementations increase `cwnd`, per Equation (17.1), where `N` is the number of previously unacknowledged bytes acknowledged in the incoming ACK.

$$cwnd+ = \min(N, SMSS) \quad (17.1)$$

During congestion avoidance, `cwnd` is incremented by roughly 1 full-sized segment per round-trip time (RTT), and for each congestion event, the slow start threshold is halved.

## CUBIC

CUBIC (class `TcpCubic`) is the default TCP congestion control in Linux, macOS (since 2014), and Microsoft Windows (since 2017). CUBIC has two main differences with respect to a more classic TCP congestion control such as NewReno. First, during the congestion avoidance phase, the window size grows according to a cubic function (concave, then convex) with the latter convex portion designed to allow for bandwidth probing. Second, a hybrid slow start (HyStart) algorithm uses observations of delay increases in the slow start phase of window growth to try to exit slow start before window growth causes queue overflow.

CUBIC is documented in [RFC 8312](#), and the `ns-3` implementation is based on the RFC more so than the Linux implementation, although the Linux 4.4 kernel implementation (through the Direct Code Execution environment) has been used to validate the behavior and is fairly well aligned (see below section on validation).

## Linux Reno

TCP Linux Reno (class `TcpLinuxReno`) is designed to provide a Linux-like implementation of TCP NewReno. The implementation of class `TcpNewReno` in `ns-3` follows RFC standards, and increases `cwnd` more conservatively than does Linux Reno. Linux Reno modifies slow start and congestion avoidance algorithms to increase `cwnd` based on the number of bytes being acknowledged by each arriving ACK, rather than by the number of ACKs that arrive. Another major difference in implementation is that Linux maintains the congestion window in units of segments, while the RFCs define the congestion window in units of bytes.

In slow start phase, on each incoming ACK at the TCP sender side `cwnd` is increased by the number of previously unacknowledged bytes ACKed by the incoming acknowledgment. In contrast, in `ns-3` NewReno, `cwnd` is increased by one segment per acknowledgment. In standards terminology, this difference is referred to as Appropriate Byte Counting (RFC 3465); Linux follows Appropriate Byte Counting while `ns-3` NewReno does not.

$$cwnd+ = segAcked * segmentSize \quad (17.2)$$

$$cwnd+ = segmentSize \quad (17.3)$$

In congestion avoidance phase, the number of bytes that have been ACKed at the TCP sender side are stored in a 'bytes\_acked' variable in the TCP control block. When 'bytes\_acked' becomes greater than or equal to the value of the `cwnd`, 'bytes\_acked' is reduced by the value of `cwnd`. Next, `cwnd` is incremented by a full-sized segment (`SMSS`). In contrast, in `ns-3` NewReno, `cwnd` is increased by  $(1/cwnd)$  with a rounding off due to type casting into int.

```
if (m_cWndCnt >= w)
{
    uint32_t delta = m_cWndCnt / w;

    m_cWndCnt -= delta * w;
    tcb->m_cWnd += delta * tcb->m_segmentSize;
```

(continues on next page)

(continued from previous page)

```

    NS_LOG_DEBUG ("Subtracting delta * w from m_cWndCnt " << delta * w);
}

:label: linuxrenocongavoid

if (segmentsAked > 0)
{
    double adder = static_cast<double> (tcb->m_segmentSize * tcb->m_segmentSize) / tcb-
    ↪->m_cWnd.Get ();
    adder = std::max (1.0, adder);
    tcb->m_cWnd += static_cast<uint32_t> (adder);
    NS_LOG_INFO ("In CongAvoid, updated to cwnd " << tcb->m_cWnd <<
        " ssthresh " << tcb->m_ssThresh);
}

:label: newrenocongavoid

```

So, there are two main difference between the TCP Linux Reno and TCP NewReno in ns-3: 1) In TCP Linux Reno, delayed acknowledgement configuration does not affect congestion window growth, while in TCP NewReno, delayed acknowledgments cause a slower congestion window growth. 2) In congestion avoidance phase, the arithmetic for counting the number of segments aked and deciding when to increment the cwnd is different for TCP Linux Reno and TCP NewReno.

Following graphs shows the behavior of window growth in TCP Linux Reno and TCP NewReno with delayed acknowledgement of 2 segments:

## HighSpeed

TCP HighSpeed is designed for high-capacity channels or, in general, for TCP connections with large congestion windows. Conceptually, with respect to the standard TCP, HighSpeed makes the cWnd grow faster during the probing phases and accelerates the cWnd recovery from losses. This behavior is executed only when the window grows beyond a certain threshold, which allows TCP HighSpeed to be friendly with standard TCP in environments with heavy congestion, without introducing new dangers of congestion collapse.

Mathematically:

$$cWnd = cWnd + \frac{a(cWnd)}{cWnd} \quad (17.4)$$

The function  $a()$  is calculated using a fixed RTT the value 100 ms (the lookup table for this function is taken from RFC 3649). For each congestion event, the slow start threshold is decreased by a value that depends on the size of the slow start threshold itself. Then, the congestion window is set to such value.

$$cWnd = (1 - b(cWnd)) \cdot cWnd \quad (17.5)$$

The lookup table for the function  $b()$  is taken from the same RFC. More information at: <http://dl.acm.org/citation.cfm?id=2756518>

## Hybla

The key idea behind TCP Hybla is to obtain for long RTT connections the same instantaneous transmission rate of a reference TCP connection with lower RTT. With analytical steps, it is shown that this goal can be achieved by modifying the time scale, in order for the throughput to be independent from the RTT. This independence is obtained through the use of a coefficient  $\rho$ .

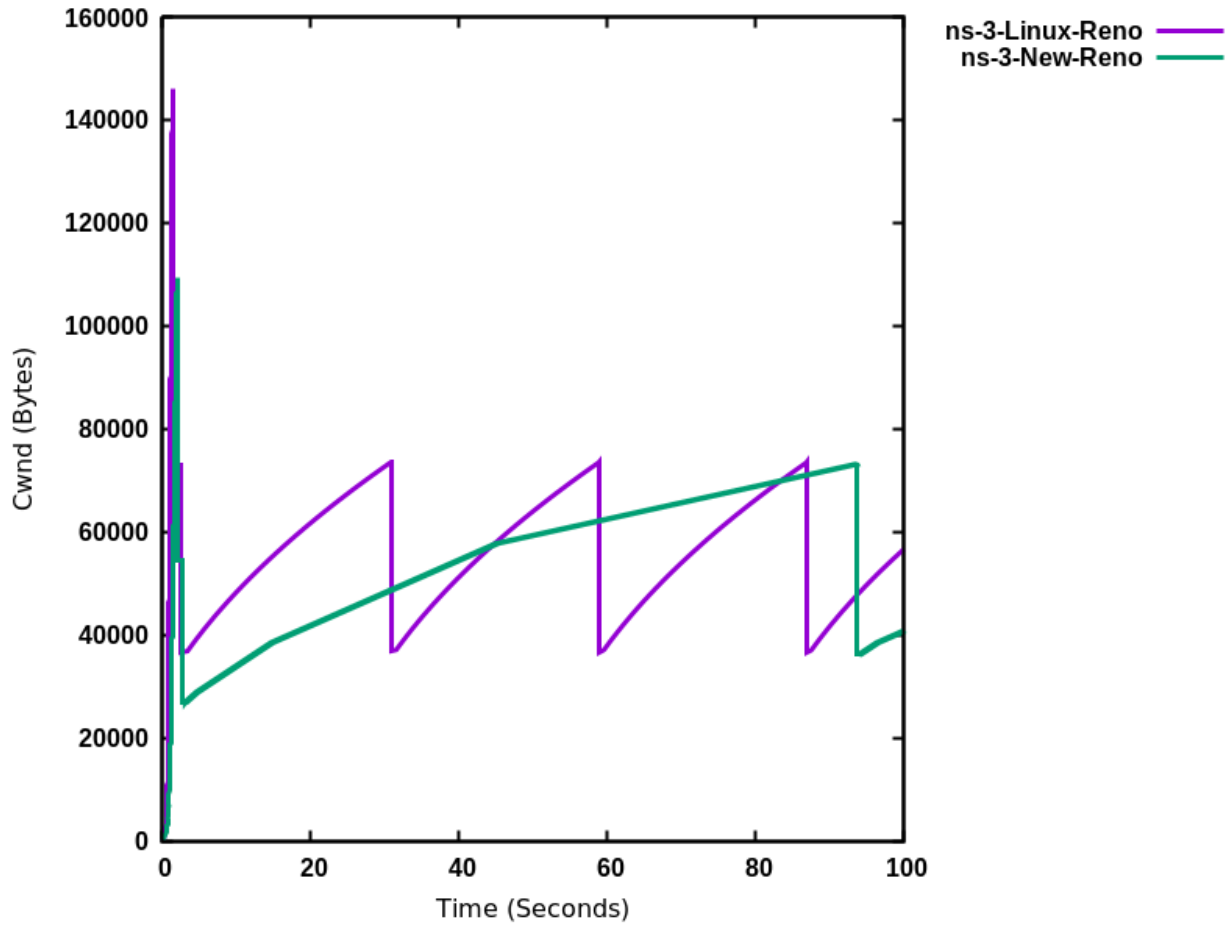

Fig. 6: ns-3 TCP NewReno vs. ns-3 TCP Linux Reno

This coefficient is used to calculate both the slow start threshold and the congestion window when in slow start and in congestion avoidance, respectively.

More information at: <http://dl.acm.org/citation.cfm?id=2756518>

## Westwood

Westwood and Westwood+ employ the AIAD (Additive Increase/Adaptive Decrease) congestion control paradigm. When a congestion episode happens, instead of halving the cwnd, these protocols try to estimate the network's bandwidth and use the estimated value to adjust the cwnd. While Westwood performs the bandwidth sampling every ACK reception, Westwood+ samples the bandwidth every RTT.

More information at: <http://dl.acm.org/citation.cfm?id=381704> and <http://dl.acm.org/citation.cfm?id=2512757>

## Vegas

TCP Vegas is a pure delay-based congestion control algorithm implementing a proactive scheme that tries to prevent packet drops by maintaining a small backlog at the bottleneck queue. Vegas continuously samples the RTT and computes the actual throughput a connection achieves using Equation (17.6) and compares it with the expected throughput calculated in Equation (17.7). The difference between these 2 sending rates in Equation (17.8) reflects the amount of extra packets being queued at the bottleneck.

$$actual = \frac{cWnd}{RTT} \quad (17.6)$$

$$expected = \frac{cWnd}{BaseRTT} \quad (17.7)$$

$$diff = expected - actual \quad (17.8)$$

To avoid congestion, Vegas linearly increases/decreases its congestion window to ensure the diff value falls between the two predefined thresholds, alpha and beta. diff and another threshold, gamma, are used to determine when Vegas should change from its slow-start mode to linear increase/decrease mode. Following the implementation of Vegas in Linux, we use 2, 4, and 1 as the default values of alpha, beta, and gamma, respectively, but they can be modified through the Attribute system.

More information at: <http://dx.doi.org/10.1109/49.464716>

## Scalable

Scalable improves TCP performance to better utilize the available bandwidth of a highspeed wide area network by altering NewReno congestion window adjustment algorithm. When congestion has not been detected, for each ACK received in an RTT, Scalable increases its cwnd per:

$$cwnd = cwnd + 0.01 \quad (17.9)$$

Following Linux implementation of Scalable, we use 50 instead of 100 to account for delayed ACK.

On the first detection of congestion in a given RTT, cwnd is reduced based on the following equation:

$$cwnd = cwnd - \text{ceil}(0.125 \cdot cwnd) \quad (17.10)$$

More information at: <http://dl.acm.org/citation.cfm?id=956989>

## Veno

TCP Veno enhances Reno algorithm for more effectively dealing with random packet loss in wireless access networks by employing Vegas's method in estimating the backlog at the bottleneck queue to distinguish between congestive and non-congestive states.

The backlog (the number of packets accumulated at the bottleneck queue) is calculated using Equation (17.11):

$$\begin{aligned} N &= Actual \cdot (RTT - BaseRTT) \\ &= Diff \cdot BaseRTT \end{aligned} \quad (17.11)$$

where:

$$\begin{aligned} Diff &= Expected - Actual \\ &= \frac{cWnd}{BaseRTT} - \frac{cWnd}{RTT} \end{aligned} \quad (17.12)$$

Veno makes decision on cwnd modification based on the calculated N and its predefined threshold beta.

Specifically, it refines the additive increase algorithm of Reno so that the connection can stay longer in the stable state by incrementing cwnd by 1/cwnd for every other new ACK received after the available bandwidth has been fully utilized, i.e. when N exceeds beta. Otherwise, Veno increases its cwnd by 1/cwnd upon every new ACK receipt as in Reno.

In the multiplicative decrease algorithm, when Veno is in the non-congestive state, i.e. when N is less than beta, Veno decrements its cwnd by only 1/5 because the loss encountered is more likely a corruption-based loss than a congestion-based. Only when N is greater than beta, Veno halves its sending rate as in Reno.

More information at: <http://dx.doi.org/10.1109/JSAC.2002.807336>

## BIC

BIC (class `TcpBic`) is a predecessor of TCP CUBIC. In TCP BIC the congestion control problem is viewed as a search problem. Taking as a starting point the current window value and as a target point the last maximum window value (i.e. the cWnd value just before the loss event) a binary search technique can be used to update the cWnd value at the midpoint between the two, directly or using an additive increase strategy if the distance from the current window is too large.

This way, assuming a no-loss period, the congestion window logarithmically approaches the maximum value of cWnd until the difference between it and cWnd falls below a preset threshold. After reaching such a value (or the maximum window is unknown, i.e. the binary search does not start at all) the algorithm switches to probing the new maximum window with a 'slow start' strategy.

If a loss occur in either these phases, the current window (before the loss) can be treated as the new maximum, and the reduced (with a multiplicative decrease factor Beta) window size can be used as the new minimum.

More information at: <http://ieeexplore.ieee.org/xpl/articleDetails.jsp?arnumber=1354672>

## YeAH

YeAH-TCP (Yet Another HighSpeed TCP) is a heuristic designed to balance various requirements of a state-of-the-art congestion control algorithm:

1. fully exploit the link capacity of high BDP networks while inducing a small number of congestion events
2. compete friendly with Reno flows
3. achieve intra and RTT fairness

4. robust to random losses
5. achieve high performance regardless of buffer size

YeAH operates between 2 modes: Fast and Slow mode. In the Fast mode when the queue occupancy is small and the network congestion level is low, YeAH increments its congestion window according to the aggressive HSTCP rule. When the number of packets in the queue grows beyond a threshold and the network congestion level is high, YeAH enters its Slow mode, acting as Reno with a decongestion algorithm. YeAH employs Vegas' mechanism for calculating the backlog as in Equation (17.13). The estimation of the network congestion level is shown in Equation (17.14).

$$Q = (RTT - BaseRTT) \cdot \frac{cWnd}{RTT} \quad (17.13)$$

$$L = \frac{RTT - BaseRTT}{BaseRTT} \quad (17.14)$$

To ensure TCP friendliness, YeAH also implements an algorithm to detect the presence of legacy Reno flows. Upon the receipt of 3 duplicate ACKs, YeAH decreases its slow start threshold according to Equation (17.15) if it's not competing with Reno flows. Otherwise, the ssthresh is halved as in Reno:

$$ssthresh = \min(\max(\frac{cWnd}{8}, Q), \frac{cWnd}{2}) \quad (17.15)$$

More information: [http://www.csc.lsu.edu/~sjpark/cs7601/4-YeAH\\_TCP.pdf](http://www.csc.lsu.edu/~sjpark/cs7601/4-YeAH_TCP.pdf)

## Illinois

TCP Illinois is a hybrid congestion control algorithm designed for high-speed networks. Illinois implements a Concave-AIMD (or C-AIMD) algorithm that uses packet loss as the primary congestion signal to determine the direction of window update and queuing delay as the secondary congestion signal to determine the amount of change.

The additive increase and multiplicative decrease factors (denoted as alpha and beta, respectively) are functions of the current average queueing delay  $da$  as shown in Equations (17.16) and (17.17). To improve the protocol robustness against sudden fluctuations in its delay sampling, Illinois allows the increment of alpha to alphaMax only if  $da$  stays below  $d1$  for a some (theta) amount of time.

$$\alpha = \begin{cases} \alpha_{Max} & \text{if } da \leq d1 \\ k1/(k2 + da) & \text{otherwise} \end{cases} \quad (17.16)$$

$$\beta = \begin{cases} \beta_{Min} & \text{if } da \leq d2 \\ k3 + k4 da & \text{if } d2 < da < d3 \\ \beta_{Max} & \text{otherwise} \end{cases} \quad (17.17)$$

where the calculations of  $k1$ ,  $k2$ ,  $k3$ , and  $k4$  are shown in the following:

$$k1 = \frac{(dm - d1) \cdot \alpha_{Min} \cdot \alpha_{Max}}{\alpha_{Max} - \alpha_{Min}} \quad (17.18)$$

$$k2 = \frac{(dm - d1) \cdot \alpha_{Min}}{\alpha_{Max} - \alpha_{Min}} - d1 \quad (17.19)$$

$$k3 = \frac{\alpha_{Min} \cdot d3 - \alpha_{Max} \cdot d2}{d3 - d2} \quad (17.20)$$

$$k4 = \frac{\alpha_{Max} - \alpha_{Min}}{d3 - d2} \quad (17.21)$$

Other parameters include  $d_a$  (the current average queueing delay), and  $T_a$  (the average RTT, calculated as  $\text{sumRtt} / \text{cntRtt}$  in the implementation) and  $T_{\min}$  ( $\text{baseRtt}$  in the implementation) which is the minimum RTT ever seen.  $d_m$  is the maximum (average) queueing delay, and  $T_{\max}$  ( $\text{maxRtt}$  in the implementation) is the maximum RTT ever seen.

$$d_a = T_a - T_{\min} \quad (17.22)$$

$$d_m = T_{\max} - T_{\min} \quad (17.23)$$

$$d_i = \eta_i \cdot d_m \quad (17.24)$$

Illinois only executes its adaptation of alpha and beta when  $\text{cwnd}$  exceeds a threshold called  $\text{winThresh}$ . Otherwise, it sets alpha and beta to the base values of 1 and 0.5, respectively.

Following the implementation of Illinois in the Linux kernel, we use the following default parameter settings:

- $\text{alphaMin} = 0.3$  (0.1 in the Illinois paper)
- $\text{alphaMax} = 10.0$
- $\text{betaMin} = 0.125$
- $\text{betaMax} = 0.5$
- $\text{winThresh} = 15$  (10 in the Illinois paper)
- $\text{theta} = 5$
- $\text{eta1} = 0.01$
- $\text{eta2} = 0.1$
- $\text{eta3} = 0.8$

More information: <http://www.doi.org/10.1145/1190095.1190166>

## H-TCP

H-TCP has been designed for high BDP (Bandwidth-Delay Product) paths. It is a dual mode protocol. In normal conditions, it works like traditional TCP with the same rate of increment and decrement for the congestion window. However, in high BDP networks, when it finds no congestion on the path after  $\text{delta1}$  seconds, it increases the window size based on the alpha function in the following:

$$\alpha(\text{delta}) = 1 + 10(\text{delta} - \text{delta1}) + 0.5(\text{delta} - \text{delta1})^2 \quad (17.25)$$

where  $\text{delta1}$  is a threshold in seconds for switching between the modes and  $\text{delta}$  is the elapsed time from the last congestion. During congestion, it reduces the window size by multiplying by beta function provided in the reference paper. The calculated throughput between the last two consecutive congestion events is considered for beta calculation.

The transport `TcpHtcp` can be selected in the program `examples/tcp/tcp-variants-comparison.cc` to perform an experiment with H-TCP, although it is useful to increase the bandwidth in this example (e.g. to 20 Mb/s) to create a higher BDP link, such as

```
./waf --run "tcp-variants-comparison --transport_prot=TcpHtcp --bandwidth=20Mbps --
↳duration=10"
```

More information (paper): <http://www.hamilton.ie/net/htcp3.pdf>

More information (Internet Draft): <https://tools.ietf.org/html/draft-leith-tcp-htcp-06>

## LEDBAT

Low Extra Delay Background Transport (LEDBAT) is an experimental delay-based congestion control algorithm that seeks to utilize the available bandwidth on an end-to-end path while limiting the consequent increase in queuing delay on that path. LEDBAT uses changes in one-way delay measurements to limit congestion that the flow itself induces in the network.

As a first approximation, the LEDBAT sender operates as shown below:

On receipt of an ACK:

```
:: currentdelay = acknowledgement.delay basedelay = min (basedelay, currentdelay) queuingdelay = currentdelay -  
    basedelay offtarget = (TARGET - queuingdelay) / TARGET cWnd += GAIN * offtarget * bytesnewlyacked *  
    MSS / cWnd
```

TARGET is the maximum queuing delay that LEDBAT itself may introduce in the network, and GAIN determines the rate at which the cwnd responds to changes in queuing delay; offtarget is a normalized value representing the difference between the measured current queuing delay and the predetermined TARGET delay. offtarget can be positive or negative; consequently, cwnd increases or decreases in proportion to offtarget.

Following the recommendation of RFC 6817, the default values of the parameters are:

- TargetDelay = 100
- baseHistoryLen = 10
- noiseFilterLen = 4
- Gain = 1

To enable LEDBAT on all TCP sockets, the following configuration can be used:

```
Config::SetDefault ("ns3::TcpL4Protocol::SocketType", TypeIdValue_  
↳ (TcpLedbat::GetTypeId ()));
```

To enable LEDBAT on a chosen TCP socket, the following configuration can be used:

```
Config::Set ("$ns3::NodeListPriv/NodeList/1/$ns3::TcpL4Protocol/SocketType",  
↳ TypeIdValue (TcpLedbat::GetTypeId ()));
```

The following unit tests have been written to validate the implementation of LEDBAT:

- LEDBAT should operate same as NewReno during slow start
- LEDBAT should operate same as NewReno if timestamps are disabled
- Test to validate cwnd increment in LEDBAT

In comparison to RFC 6817, the scope and limitations of the current LEDBAT implementation are:

- It assumes that the clocks on the sender side and receiver side are synchronised
- In line with Linux implementation, the one-way delay is calculated at the sender side by using the timestamps option in TCP header
- Only the MIN function is used for noise filtering

More information about LEDBAT is available in RFC 6817: <https://tools.ietf.org/html/rfc6817>



## TCP-LP

TCP-Low Priority (TCP-LP) is a delay based congestion control protocol in which the low priority data utilizes only the excess bandwidth available on an end-to-end path. TCP-LP uses one way delay measurements as an indicator of congestion as it does not influence cross-traffic in the reverse direction.

On receipt of an ACK:

$$Onewaydelay = Receivertimestamp - ReceivertimestampechoreplySmoothedonewaydelay = 7/8 * OldSmoothedonewayd$$

where `owdMin` and `owdMax` are the minimum and maximum one way delays experienced throughout the connection, `LP_WITHIN_INF` indicates if TCP-LP is in inference phase or not

More information (paper): <http://cs.northwestern.edu/~akuzma/rice/doc/TCP-LP.pdf>

## Data Center TCP (DCTCP)

DCTCP, specified in RFC 8257 and implemented in Linux, is a TCP congestion control algorithm for data center networks. It leverages Explicit Congestion Notification (ECN) to provide more fine-grained congestion feedback to the end hosts, and is intended to work with routers that implement a shallow congestion marking threshold (on the order of a few milliseconds) to achieve high throughput and low latency in the datacenter. However, because DCTCP does not react in the same way to notification of congestion experienced, there are coexistence (fairness) issues between it and legacy TCP congestion controllers, which is why it is recommended to only be used in controlled networking environments such as within data centers.

DCTCP extends the Explicit Congestion Notification signal to estimate the fraction of bytes that encounter congestion, rather than simply detecting that the congestion has occurred. DCTCP then scales the congestion window based on this estimate. This approach achieves high burst tolerance, low latency, and high throughput with shallow-buffered switches.

- *Receiver functionality:* If CE is observed in the IP header of an incoming packet at the TCP receiver, the receiver sends congestion notification to the sender by setting ECE in TCP header. This processing is different from standard receiver ECN processing which sets and holds the ECE bit for every ACK until it observes a CWR signal from the TCP sender.
- *Sender functionality:* The sender makes use of the modified receiver ECE semantics to maintain an estimate of the fraction of packets marked ( $\alpha$ ) by using the exponential weighted moving average (EWMA) as shown below:

$$\alpha = (1 - g) * \alpha + g * F$$

In the above EWMA:

- $g$  is the estimation gain (between 0 and 1)
- $F$  is the fraction of packets marked in current RTT.

For send windows in which at least one ACK was received with ECE set, the sender should respond by reducing the congestion window as follows, once for every window of data:

$$cwnd = cwnd * (1 - \alpha/2)$$

Following the recommendation of RFC 8257, the default values of the parameters are:

$$g = 0.0625(i.e., 1/16)$$

$$initialalpha(\alpha) = 1$$

To enable DCTCP on all TCP sockets, the following configuration can be used:

```
Config::SetDefault ("ns3::TcpL4Protocol::SocketType", TypeIdValue_  
↳ (TcpDctcp::GetTypeId ()));
```

To enable DCTCP on a selected node, one can set the “SocketType” attribute on the `TcpL4Protocol` object of that node to the `TcpDctcp` TypeId.

The ECN is enabled automatically when DCTCP is used, even if the user has not explicitly enabled it.

DCTCP depends on a simple queue management algorithm in routers / switches to mark packets. The current implementation of DCTCP in ns-3 can use RED with a simple configuration to achieve the behavior of desired queue management algorithm.

To configure RED router for DCTCP:

```
Config::SetDefault ("ns3::RedQueueDisc::UseEcn", BooleanValue (true));  
Config::SetDefault ("ns3::RedQueueDisc::QW", DoubleValue (1.0));  
Config::SetDefault ("ns3::RedQueueDisc::MinTh", DoubleValue (16));  
Config::SetDefault ("ns3::RedQueueDisc::MaxTh", DoubleValue (16));
```

There is also the option, when running CoDel or FqCoDel, to enable ECN on the queue and to set the “CeThreshold” value to a low value such as 1ms. The following example uses CoDel:

```
Config::SetDefault ("ns3::CoDelQueueDisc::UseEcn", BooleanValue (true));  
Config::SetDefault ("ns3::CoDelQueueDisc::CeThreshold", TimeValue (Milliseconds (1)));
```

The following unit tests have been written to validate the implementation of DCTCP:

- ECT flags should be set for SYN, SYN+ACK, ACK and data packets for DCTCP traffic
- ECT flags should not be set for SYN, SYN+ACK and pure ACK packets, but should be set on data packets for ECN enabled traditional TCP flows
- ECE should be set only when CE flags are received at receiver and even if sender doesn’t send CWR, receiver should not send ECE if it doesn’t receive packets with CE flags

An example program, `examples/tcp/tcp-validation.cc`, can be used to experiment with DCTCP for long-running flows with different bottleneck link bandwidth, base RTTs, and queuing disciplines. A variant of this program has also been run using the ns-3 Direct Code Execution environment using DCTCP from Linux kernel 4.4, and the results were compared against ns-3 results.

An example program based on an experimental topology found in the original DCTCP SIGCOMM paper is provided in `examples/tcp/dctcp-example.cc`. This example uses a simple topology consisting of forty DCTCP senders and receivers and two ECN-enabled switches to examine throughput, fairness, and queue delay properties of the network.

This implementation was tested extensively against a version of DCTCP in the Linux kernel version 4.4 using the ns-3 direct code execution (DCE) environment. Some differences were noted:

- Linux maintains its congestion window in segments and not bytes, and the arithmetic is not floating point, so small differences in the evolution of congestion window have been observed.
- Linux uses pacing, where packets to be sent are paced out at regular intervals. However, if at any instant the number of segments that can be sent are less than two, Linux does not pace them and instead sends them back-to-back. Currently, ns-3 paces out all packets eligible to be sent in the same manner.

More information about DCTCP is available in the RFC 8257: <https://tools.ietf.org/html/rfc8257>

## Support for Explicit Congestion Notification (ECN)

ECN provides end-to-end notification of network congestion without dropping packets. It uses two bits in the IP header: ECN Capable Transport (ECT bit) and Congestion Experienced (CE bit), and two bits in the TCP header:

Congestion Window Reduced (CWR) and ECN Echo (ECE).

More information is available in RFC 3168: <https://tools.ietf.org/html/rfc3168>

The following ECN states are declared in `src/internet/model/tcp-socket-state.h`

```
typedef enum
{
    ECN_DISABLED = 0,    //!< ECN disabled traffic
    ECN_IDLE,           //!< ECN is enabled but currently there is no action pertaining
    ↪to ECE or CWR to be taken
    ECN_CE_RCVD,        //!< Last packet received had CE bit set in IP header
    ECN_SENDING_ECE,    //!< Receiver sends an ACK with ECE bit set in TCP header
    ECN_ECE_RCVD,       //!< Last ACK received had ECE bit set in TCP header
    ECN_CWR_SENT        //!< Sender has reduced the congestion window, and sent a
    ↪packet with CWR bit set in TCP header. This is used for tracing.
} EcnStates_t;
```

Current implementation of ECN is based on RFC 3168 and is referred as Classic ECN.

The following enum represents the mode of ECN:

```
typedef enum
{
    ClassicEcn,    //!< ECN functionality as described in RFC 3168.
    DctcpEcn,     //!< ECN functionality as described in RFC 8257. Note: this mode is
    ↪specific to DCTCP.
} EcnMode_t;
```

The following are some important ECN parameters:

```
// ECN parameters
EcnMode_t          m_ecnMode {ClassicEcn};    //!< ECN mode
UseEcn_t           m_useEcn {Off};           //!< Socket ECN capability
```

## Enabling ECN

By default, support for ECN is disabled in TCP sockets. To enable, change the value of the attribute `ns3::TcpSocketBase::UseEcn` to `On`. Following are supported values for the same, this functionality is aligned with Linux: <https://www.kernel.org/doc/Documentation/networking/ip-sysctl.txt>

```
typedef enum
{
    Off          = 0,    //!< Disable
    On           = 1,    //!< Enable
    AcceptOnly = 2,    //!< Enable only when the peer endpoint is ECN capable
} UseEcn_t;
```

For example:

```
Config::SetDefault ("ns3::TcpSocketBase::UseEcn", StringValue ("On"))
```

## ECN negotiation

ECN capability is negotiated during the three-way TCP handshake:

### 1. Sender sends SYN + CWR + ECE

```
if (m_useEcn == UseEcn_t::On)
{
    SendEmptyPacket (TcpHeader::SYN | TcpHeader::ECE | TcpHeader::CWR);
}
else
{
    SendEmptyPacket (TcpHeader::SYN);
}
m_ecnState = ECN_DISABLED;
```

### 2. Receiver sends SYN + ACK + ECE

```
if (m_useEcn != UseEcn_t::Off && (tcpHeader.GetFlags () & (TcpHeader::CWR |
↪TcpHeader::ECE)) == (TcpHeader::CWR | TcpHeader::ECE))
{
    SendEmptyPacket (TcpHeader::SYN | TcpHeader::ACK | TcpHeader::ECE);
    m_ecnState = ECN_IDLE;
}
else
{
    SendEmptyPacket (TcpHeader::SYN | TcpHeader::ACK);
    m_ecnState = ECN_DISABLED;
}
```

### 3. Sender sends ACK

```
if (m_useEcn != UseEcn_t::Off && (tcpHeader.GetFlags () & (TcpHeader::CWR |
↪TcpHeader::ECE)) == (TcpHeader::ECE))
{
    m_ecnState = ECN_IDLE;
}
else
{
    m_ecnState = ECN_DISABLED;
}
```

Once the ECN-negotiation is successful, the sender sends data packets with ECT bits set in the IP header.

Note: As mentioned in [Section 6.1.1 of RFC 3168](#), ECT bits should not be set during ECN negotiation. The ECN negotiation implemented in *ns-3* follows this guideline.

## ECN State Transitions

1. Initially both sender and receiver have their `m_ecnState` set as `ECN_DISABLED`
2. Once the ECN negotiation is successful, their states are set to `ECN_IDLE`
3. The receiver's state changes to `ECN_CE_RCVD` when it receives a packet with CE bit set. The state then moves to `ECN_SENDING_ECE` when the receiver sends an ACK with ECE set. This state is retained until a CWR is received, following which, the state changes to `ECN_IDLE`.
4. When the sender receives an ACK with ECE bit set from receiver, its state is set as `ECN_ECE_RCVD`
5. The sender's state changes to `ECN_CWR_SENT` when it sends a packet with CWR bit set. It remains in this state until an ACK with valid ECE is received (i.e., ECE is received for a packet that belongs to a new window), following which, its state changes to `ECN_ECE_RCVD`.

## RFC 3168 compliance

Based on the suggestions provided in RFC 3168, the following behavior has been implemented:

1. Pure ACK packets should not have the ECT bit set (Section 6.1.4).
2. In the current implementation, the sender only sends ECT(0) in the IP header.
3. The sender should reduce the congestion window only once in each window (Section 6.1.2).
4. The receiver should ignore the CE bits set in a packet arriving out of window (Section 6.1.5).
5. The sender should ignore the ECE bits set in the packet arriving out of window (Section 6.1.2).

## Open issues

The following issues are yet to be addressed:

1. Retransmitted packets should not have the CWR bit set (Section 6.1.5).
2. Despite the congestion window size being 1 MSS, the sender should reduce its congestion window by half when it receives a packet with the ECE bit set. The sender must reset the retransmit timer on receiving the ECN-Echo packet when the congestion window is one. The sending TCP will then be able to send a new packet only when the retransmit timer expires (Section 6.1.2).
3. Support for separately handling the enabling of ECN on the incoming and outgoing TCP sessions (e.g. a TCP may perform ECN echoing but not set the ECT codepoints on its outbound data segments).

## Support for Dynamic Pacing

TCP pacing refers to the sender-side practice of scheduling the transmission of a burst of eligible TCP segments across a time interval such as a TCP RTT, to avoid or reduce bursts. Historically, TCP used the natural ACK clocking mechanism to pace segments, but some network paths introduce aggregation (bursts of ACKs arriving) or ACK thinning, either of which disrupts ACK clocking. Some latency-sensitive congestion controls under development (Prague, BBR) require pacing to operate effectively.

Until recently, the state of the art in Linux was to support pacing in one of two ways:

- 1) fq/pacing with sch\_fq
- 2) TCP internal pacing

The presentation by Dumazet and Cheng at IETF 88 summarizes: <https://www.ietf.org/proceedings/88/slides/slides-88-tcpm-9.pdf>

The first option was most often used when offloading (TSO) was enabled and when the sch\_fq scheduler was used at the traffic control (qdisc) sublayer. In this case, TCP was responsible for setting the socket pacing rate, but the qdisc sublayer would enforce it. When TSO was enabled, the kernel would break a large burst into smaller chunks, with dynamic sizing based on the pacing rate, and hand off the segments to the fq qdisc for pacing.

The second option was used if sch\_fq was not enabled; TCP would be responsible for internally pacing.

In 2018, Linux switched to an Early Departure Model (EDM): <https://lwn.net/Articles/766564/>.

TCP pacing in Linux was added in kernel 3.12, and authors chose to allow a pacing rate of 200% against the current rate, to allow probing for optimal throughput even during slow start phase. Some refinements were added in <https://git.kernel.org/pub/scm/linux/kernel/git/torvalds/linux.git/commit/?id=43e122b014c9>, in which Google reported that it was better to apply a different ratio (120%) in Congestion Avoidance phase. Furthermore, authors found that after cwnd reduction, it was helpful to become more conservative and switch to the conservative ratio (120%) as soon as

$cwnd \geq ssthresh/2$ , as the initial ramp up (when  $ssthresh$  is infinite) still allows doubling  $cwnd$  every other RTT. Linux also does not pace the initial window (IW), typically 10 segments in practice.

Linux has also been observed to not pace if the number of eligible segments to be sent is exactly two; they will be sent back to back. If three or more, the first two are sent immediately, and additional segments are paced at the current pacing rate.

In ns-3, the model is as follows. There is no TSO/sch\_fq model; only internal pacing according to current Linux policy.

Pacing may be enabled for any TCP congestion control, and a maximum pacing rate can be set. Furthermore, dynamic pacing is enabled for all TCP variants, according to the following guidelines.

- Pacing of the initial window (IW) is not done by default but can be separately enabled.
- Pacing of the initial slow start, after IW, is done according to the pacing rate of 200% of the current rate, to allow for window growth. This pacing rate can be configured to a different value than 200%.
- Pacing of congestion avoidance phase is done at a pacing rate of 120% of current rate. This can be configured to a different value than 120%.
- Pacing of subsequent slow start is done according to the following heuristic. If  $cwnd < ssthresh/2$ , such as after a timeout or idle period, pace at the slow start rate (200%). Otherwise, pace at the congestion avoidance rate.

Dynamic pacing is demonstrated by the example program `examples/tcp/tcp-pacing.cc`.

### Validation

The following tests are found in the `src/internet/test` directory. In general, TCP tests inherit from a class called `TcpGeneralTest`, which provides common operations to set up test scenarios involving TCP objects. For more information on how to write new tests, see the section below on [Writing TCP tests](#).

- **tcp:** Basic transmission of string of data from client to server
- **tcp-bytes-in-flight-test:** TCP correctly estimates bytes in flight under loss conditions
- **tcp-cong-avoid-test:** TCP congestion avoidance for different packet sizes
- **tcp-datasentcb:** Check TCP's 'data sent' callback
- **tcp-endpoint-bug2211-test:** A test for an issue that was causing stack overflow
- **tcp-fast-retr-test:** Fast Retransmit testing
- **tcp-header:** Unit tests on the TCP header
- **tcp-highspeed-test:** Unit tests on the HighSpeed congestion control
- **tcp-htcp-test:** Unit tests on the H-TCP congestion control
- **tcp-hybla-test:** Unit tests on the Hybla congestion control
- **tcp-vegas-test:** Unit tests on the Vegas congestion control
- **tcp-veno-test:** Unit tests on the Veno congestion control
- **tcp-scalable-test:** Unit tests on the Scalable congestion control
- **tcp-bic-test:** Unit tests on the BIC congestion control
- **tcp-yeah-test:** Unit tests on the YeAH congestion control
- **tcp-illinois-test:** Unit tests on the Illinois congestion control
- **tcp-ledbat-test:** Unit tests on the LEDBAT congestion control

- **tcp-lp-test:** Unit tests on the TCP-LP congestion control
- **tcp-dctcp-test:** Unit tests on the DCTCP congestion control
- **tcp-option:** Unit tests on TCP options
- **tcp-pkts-acked-test:** Unit test the number of time that PktsAcked is called
- **tcp-rto-test:** Unit test behavior after a RTO occurs
- **tcp-rtt-estimation-test:** Check RTT calculations, including retransmission cases
- **tcp-slow-start-test:** Check behavior of slow start
- **tcp-timestamp:** Unit test on the timestamp option
- **tcp-wscaling:** Unit test on the window scaling option
- **tcp-zero-window-test:** Unit test persist behavior for zero window conditions
- **tcp-close-test:** Unit test on the socket closing: both receiver and sender have to close their socket when all bytes are transferred
- **tcp-ecn-test:** Unit tests on Explicit Congestion Notification
- **tcp-pacing-test:** Unit tests on dynamic TCP pacing rate

Several tests have dependencies outside of the `internet` module, so they are located in a system test directory called `src/test/ns3tcp`. Three of these six tests involve use of the Network Simulation Cradle, and are disabled if NSC is not enabled in the build.

- **ns3-tcp-cwnd:** Check to see that ns-3 TCP congestion control works against liblinux2.6.26.so implementation
- **ns3-tcp-interoperability:** Check to see that ns-3 TCP interoperates with liblinux2.6.26.so implementation
- **ns3-tcp-loss:** Check behavior of ns-3 TCP upon packet losses
- **nsc-tcp-loss:** Check behavior of NSC TCP upon packet losses
- **ns3-tcp-no-delay:** Check that ns-3 TCP Nagle’s algorithm works correctly and that it can be disabled
- **ns3-tcp-socket:** Check that ns-3 TCP successfully transfers an application data write of various sizes
- **ns3-tcp-state:** Check the operation of the TCP state machine for several cases

Several TCP validation test results can also be found in the [wiki page](#) describing this implementation.

The ns-3 implementation of TCP Linux Reno was validated against the NewReno implementation of Linux kernel 4.4.0 using ns-3 Direct Code Execution (DCE). DCE is a framework which allows the users to run kernel space protocol inside ns-3 without changing the source code.

In this validation, cwnd traces of DCE Linux `reno` were compared to those of ns-3 Linux Reno and NewReno for a delayed acknowledgement configuration of 1 segment (in the ns-3 implementation; Linux does not allow direct configuration of this setting). It can be observed that cwnd traces for ns-3 Linux Reno are closely overlapping with DCE `reno`, while for ns-3 NewReno there was deviation in the congestion avoidance phase.

The difference in the cwnd in the early stage of this flow is because of the way cwnd is plotted. As ns-3 provides a trace source for cwnd, an ns-3 Linux Reno cwnd simple is obtained every time the cwnd value changes, whereas for DCE Linux Reno, the kernel does not have a corresponding trace source. Instead, we use the “ss” command of the Linux kernel to obtain cwnd values. The “ss” samples cwnd at an interval of 0.5 seconds.

TCP ECN operation is tested in the ARED and RED tests that are documented in the traffic-control module documentation.

Figure *DCTCP throughput for 10ms/50Mbps bottleneck, 1ms CE threshold* shows a long-running file transfer using DCTCP over a 50 Mbps bottleneck (running CoDel queue disc with a 1ms CE threshold setting) with a 10 ms base RTT. The figure shows that DCTCP reaches link capacity very quickly and stays there for the duration with minimal

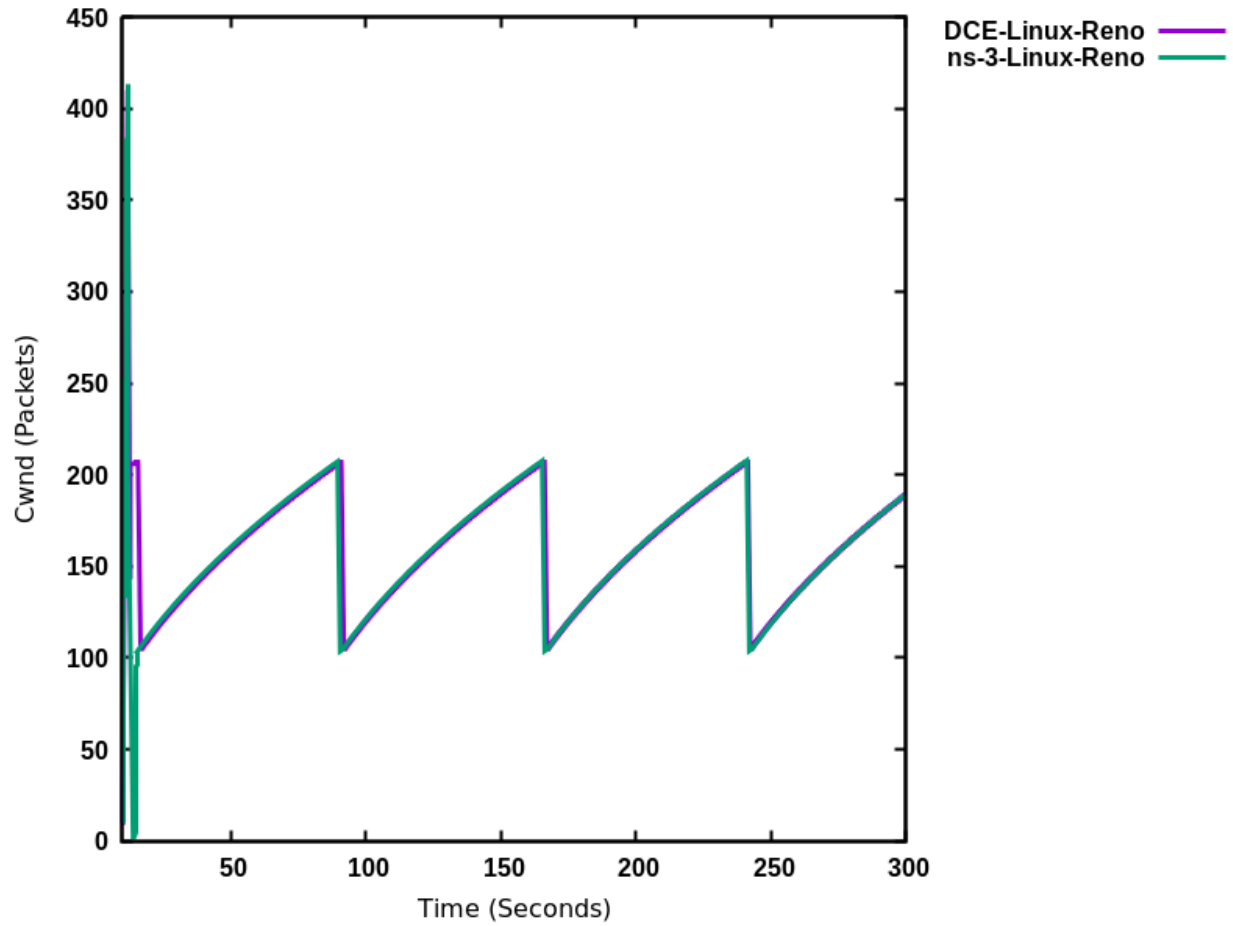

Fig. 7: DCE Linux Reno vs. ns-3 Linux Reno



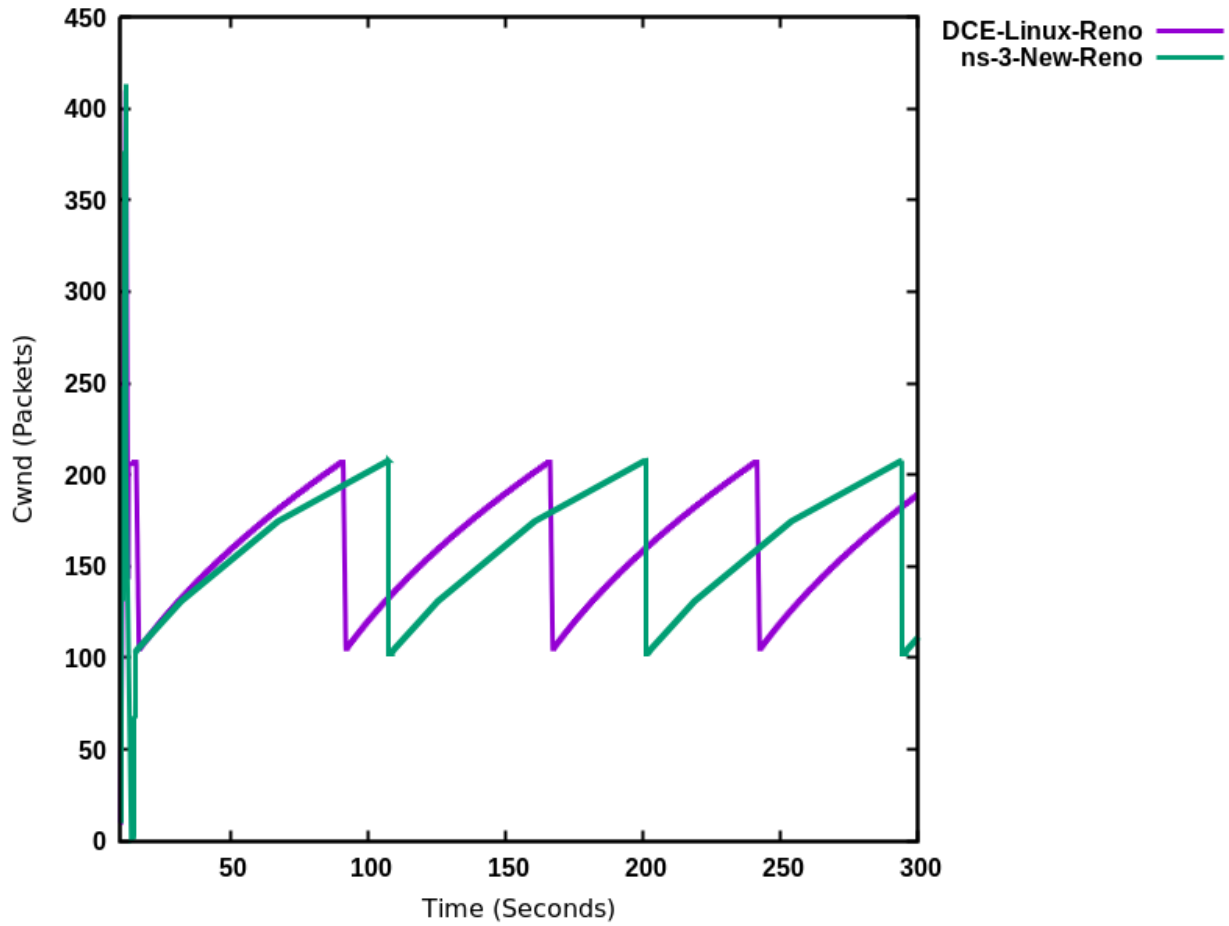

Fig. 8: DCE Linux Reno vs. ns-3 Linux Reno

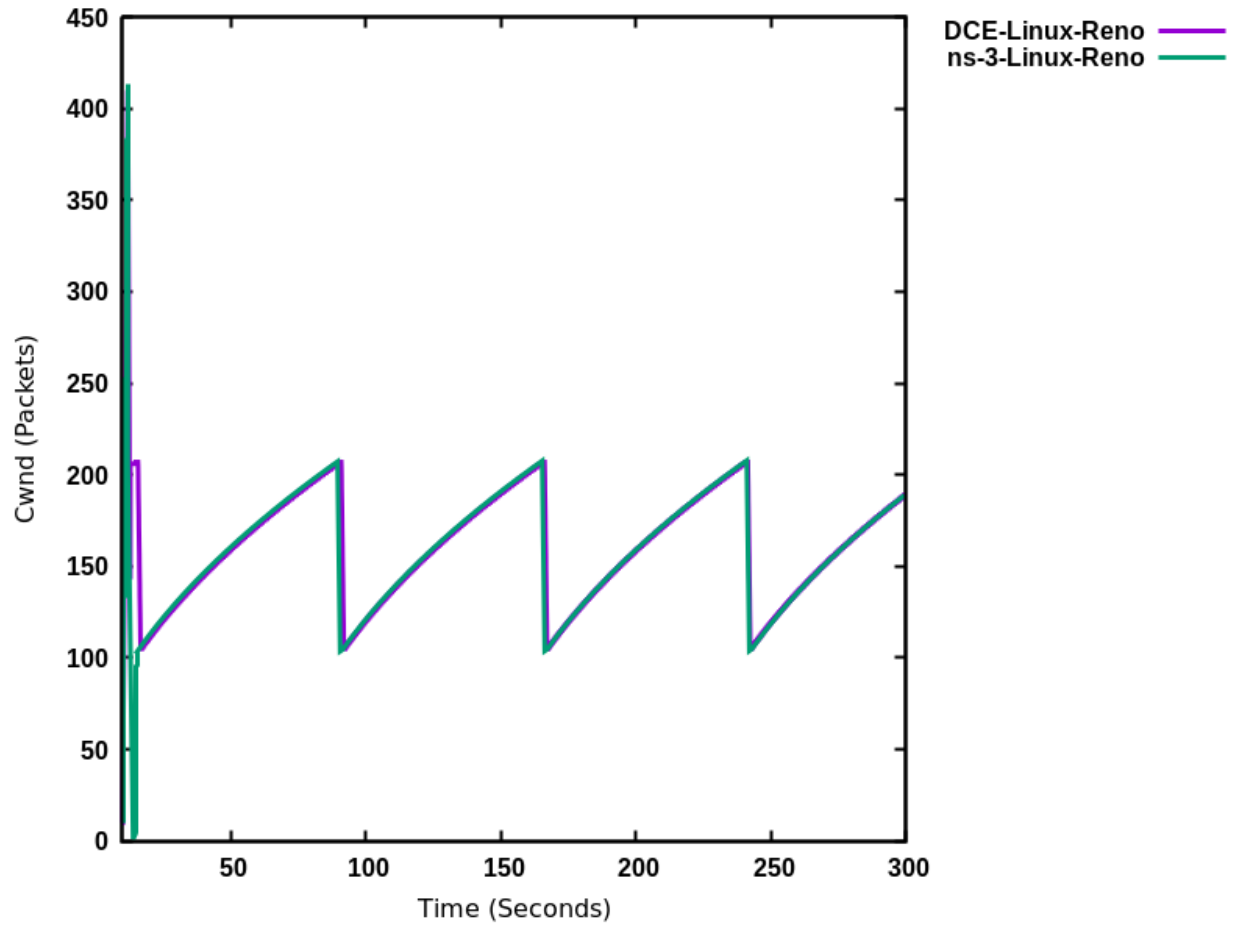

Fig. 9: DCE Linux Reno vs. ns-3 Linux Reno

change in throughput. In contrast, Figure *DCTCP throughput for 80ms/50Mbps bottleneck, 1ms CE threshold* plots the throughput for the same configuration except with an 80 ms base RTT. In this case, the DCTCP exits slow start early and takes a long time to build the flow throughput to the bottleneck link capacity. DCTCP is not intended to be used at such a large base RTT, but this figure highlights the sensitivity to RTT (and can be reproduced using the Linux implementation).

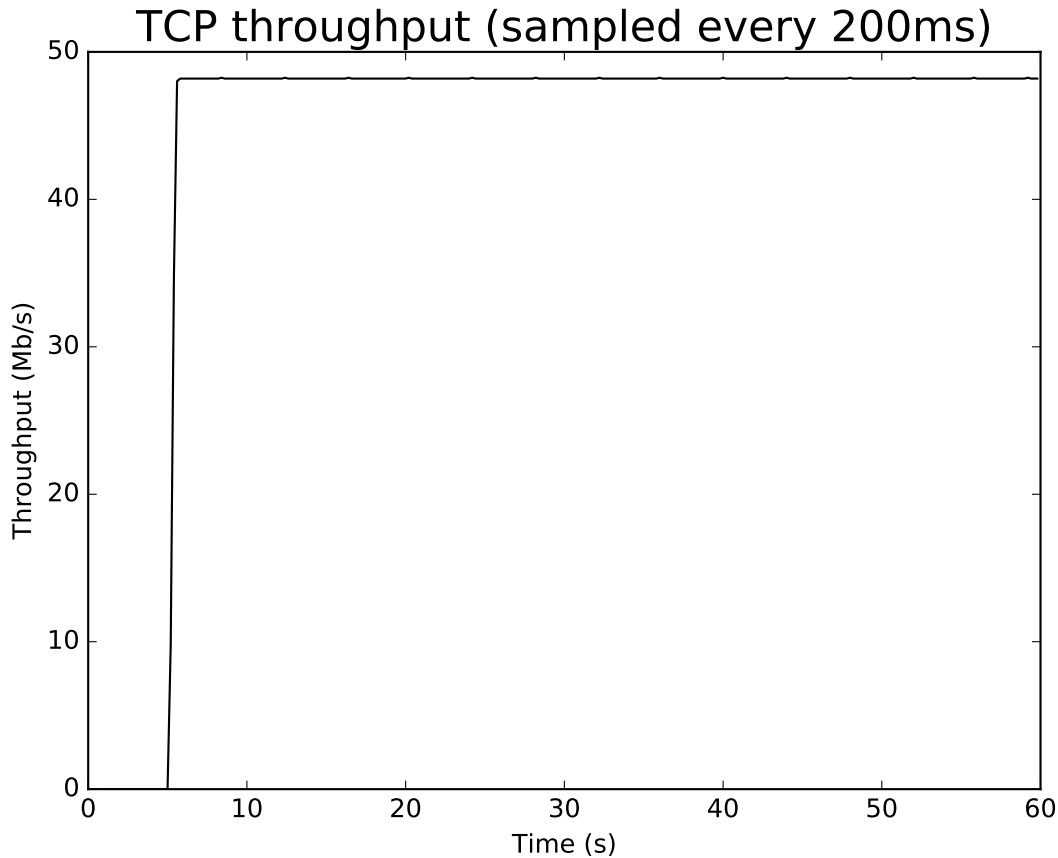

Fig. 10: DCTCP throughput for 10ms/50Mbps bottleneck, 1ms CE threshold

Similar to DCTCP, TCP CUBIC has been tested against the Linux kernel version 4.4 implementation. Figure *CUBIC cwnd evolution for 50ms/50Mbps bottleneck, no ECN* compares the congestion window evolution between ns-3 and Linux for a single flow operating over a 50 Mbps link with 50 ms base RTT and the CoDel AQM. Some differences can be observed between the peak of slow start window growth (ns-3 exits slow start earlier due to its HyStart implementation), and the window growth is a bit out-of-sync (likely due to different implementations of the algorithm), but the cubic concave/convex window pattern, and the signs of TCP CUBIC fast convergence algorithm (alternating patterns of cubic and concave window growth) can be observed. The ns-3 congestion window is maintained in bytes (unlike Linux which uses segments) but has been normalized to segments for these plots. Figure *CUBIC cwnd evolution for 50ms/50Mbps bottleneck, with ECN* displays the outcome of a similar scenario but with ECN enabled throughout.

### Writing a new congestion control algorithm

Writing (or porting) a congestion control algorithms from scratch (or from other systems) is a process completely separated from the internals of TcpSocketBase.

All operations that are delegated to a congestion control are contained in the class TcpCongestionOps. It mimics the

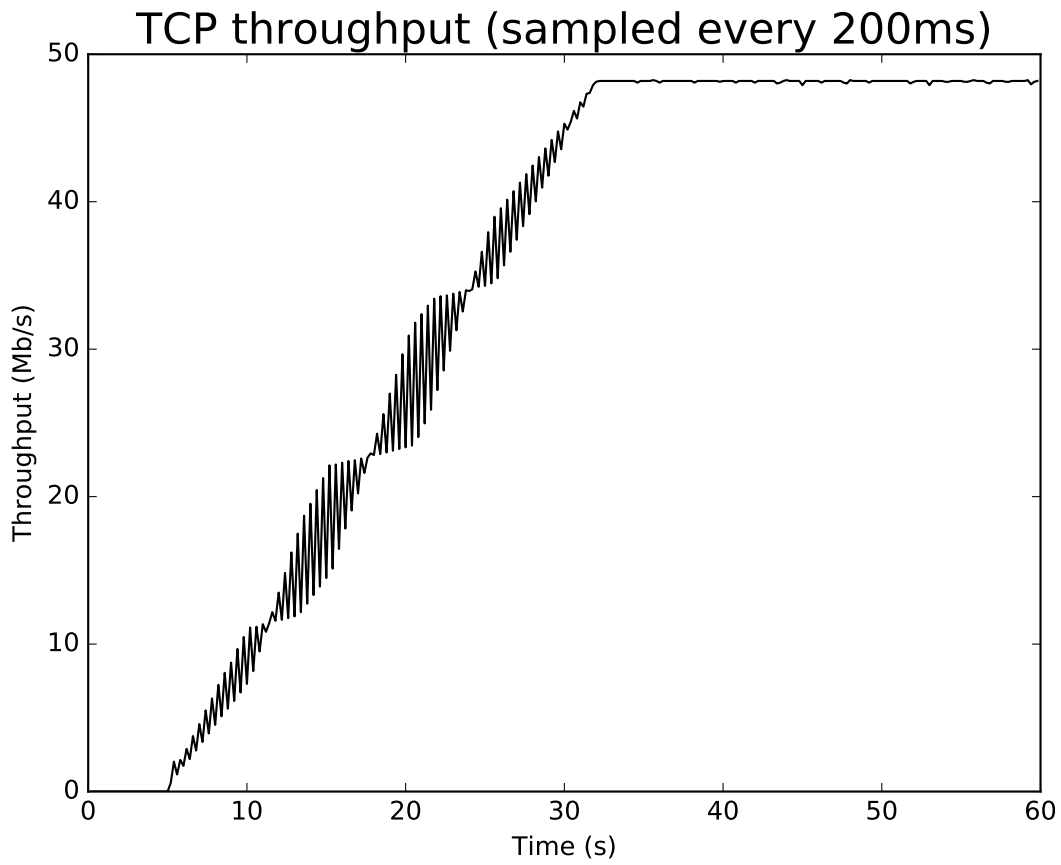

Fig. 11: DCTCP throughput for 80ms/50Mbps bottleneck, 1ms CE threshold

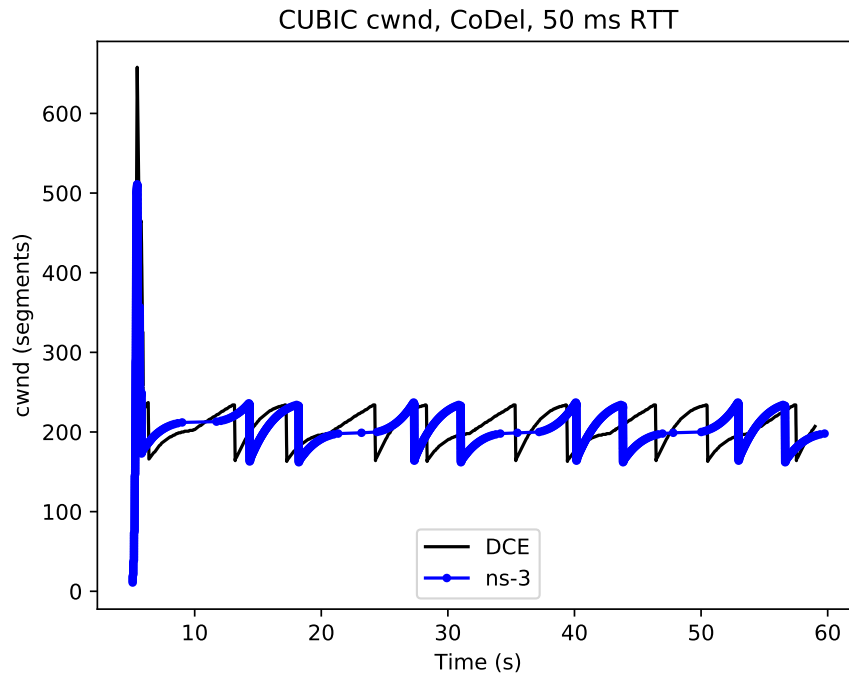

Fig. 12: CUBIC cwnd evolution for 50ms/50Mbps bottleneck, no ECN

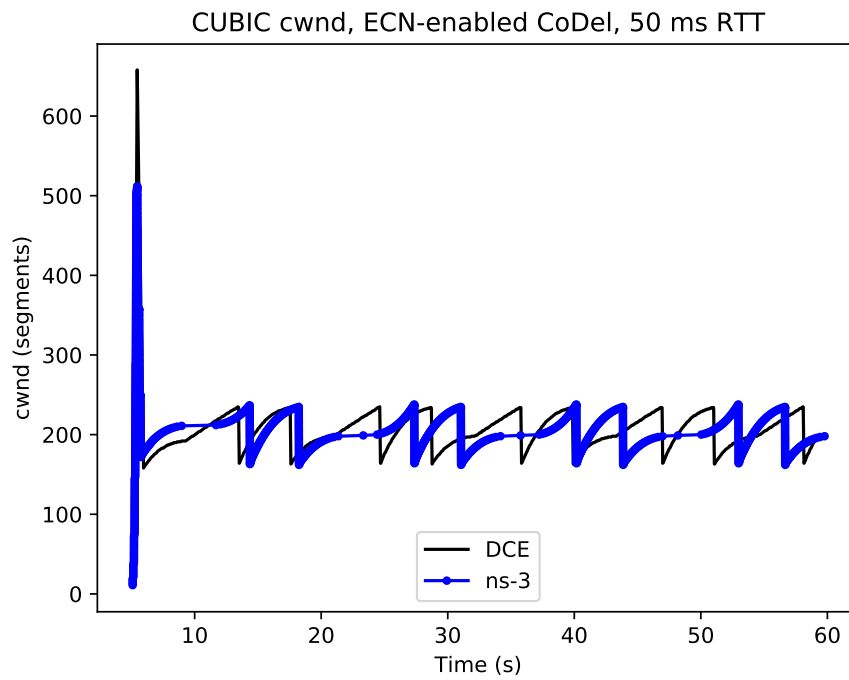

Fig. 13: CUBIC cwnd evolution for 50ms/50Mbps bottleneck, with ECN

structure `tcp_congestion_ops` of Linux, and the following operations are defined:

```
virtual std::string GetName () const;
virtual uint32_t GetSsThresh (Ptr<const TcpSocketState> tcb, uint32_t bytesInFlight);
virtual void IncreaseWindow (Ptr<TcpSocketState> tcb, uint32_t segmentsAacked);
virtual void PktsAacked (Ptr<TcpSocketState> tcb, uint32_t segmentsAacked, const Time& rtt);
virtual Ptr<TcpCongestionOps> Fork ();
virtual void CwndEvent (Ptr<TcpSocketState> tcb, const TcpSocketState::TcpCaEvent_t event);
```

The most interesting methods to write are `GetSsThresh` and `IncreaseWindow`. The latter is called when `TcpSocketBase` decides that it is time to increase the congestion window. Much information is available in the Transmission Control Block, and the method should increase `cWnd` and/or `ssThresh` based on the number of segments acked.

`GetSsThresh` is called whenever the socket needs an updated value of the slow start threshold. This happens after a loss; congestion control algorithms are then asked to lower such value, and to return it.

`PktsAacked` is used in case the algorithm needs timing information (such as RTT), and it is called each time an ACK is received.

`CwndEvent` is used in case the algorithm needs the state of socket during different congestion window event.

## TCP SACK and non-SACK

To avoid code duplication and the effort of maintaining two different versions of the TCP core, namely RFC 6675 (TCP-SACK) and RFC 5681 (TCP congestion control), we have merged RFC 6675 in the current code base. If the receiver supports the option, the sender bases its retransmissions over the received SACK information. However, in the absence of that option, the best it can do is to follow the RFC 5681 specification (on Fast Retransmit/Recovery) and employing NewReno modifications in case of partial ACKs.

A similar concept is used in Linux with the function `tcp_add_reno_sack`. Our implementation resides in the `TcpTxBuffer` class that implements a scoreboard through two different lists of segments. `TcpSocketBase` actively uses the API provided by `TcpTxBuffer` to query the scoreboard; please refer to the Doxygen documentation (and to in-code comments) if you want to learn more about this implementation.

For an academic peer-reviewed paper on the SACK implementation in ns-3, please refer to <https://dl.acm.org/citation.cfm?id=3067666>.

## Loss Recovery Algorithms

The following loss recovery algorithms are supported in ns-3 TCP. The current default (as of ns-3.32 release) is Proportional Rate Reduction (PRR), while the default for ns-3.31 and earlier was Classic Recovery.

### Classic Recovery

Classic Recovery refers to the combination of NewReno algorithm described in RFC 6582 along with SACK based loss recovery algorithm mentioned in RFC 6675. SACK based loss recovery is used when sender and receiver support SACK options. In the case when SACK options are disabled, the NewReno modification handles the recovery.

At the start of recovery phase the congestion window is reduced differently for NewReno and SACK based recovery. For NewReno the reduction is done as given below:

$$cWnd = ssThresh$$

For SACK based recovery, this is done as follows:

$$cWnd = ssThresh + (dupAckCount * segmentSize)$$

While in the recovery phase, the congestion window is inflated by `segmentSize` on arrival of every ACK when `NewReno` is used. The congestion window is kept same when SACK based loss recovery is used.

### Proportional Rate Reduction

Proportional Rate Reduction (PRR) is a loss recovery algorithm described in RFC 6937 and currently used in Linux. The design of PRR helps in avoiding excess window adjustments and aims to keep the congestion window as close as possible to `ssThresh`.

PRR updates the congestion window by comparing the values of `bytesInFlight` and `ssThresh`. If the value of `bytesInFlight` is greater than `ssThresh`, congestion window is updated as shown below:

$$sndcnt = CEIL(prrDelivered * ssThresh / RecoverFS) - prrOut$$

$$cWnd = pipe + sndcnt$$

where `RecoverFS` is the value of `bytesInFlight` at the start of recovery phase, `prrDelivered` is the total bytes delivered during recovery phase, `prrOut` is the total bytes sent during recovery phase and `sndcnt` represents the number of bytes to be sent in response to each ACK.

Otherwise, the congestion window is updated by either using Conservative Reduction Bound (CRB) or Slow Start Reduction Bound (SSRB) with SSRB being the default Reduction Bound. Each Reduction Bound calculates a maximum data sending limit. For CRB, the limit is calculated as shown below:

$$limit = prrDelivered - prrout$$

For SSRB, it is calculated as:

$$limit = MAX(prrDelivered - prrOut, DeliveredData) + MSS$$

where `DeliveredData` represents the total number of bytes delivered to the receiver as indicated by the current ACK and `MSS` is the maximum segment size.

After limit calculation, the `cWnd` is updated as given below:

$$sndcnt = MIN(ssThresh - pipe, limit)$$

$$cWnd = pipe + sndcnt$$

More information (paper): <https://dl.acm.org/citation.cfm?id=2068832>

More information (RFC): <https://tools.ietf.org/html/rfc6937>

### Adding a new loss recovery algorithm in ns-3

Writing (or porting) a loss recovery algorithms from scratch (or from other systems) is a process completely separated from the internals of `TcpSocketBase`.

All operations that are delegated to a loss recovery are contained in the class `TcpRecoveryOps` and are given below:

```
virtual std::string GetName () const;
virtual void EnterRecovery (Ptr<const TcpSocketState> tcb, uint32_t unAckDataCount,
                           bool isSackEnabled, uint32_t dupAckCount,
                           uint32_t bytesInFlight, uint32_t lastDeliveredBytes);
virtual void DoRecovery (Ptr<const TcpSocketState> tcb, uint32_t unAckDataCount,
                       bool isSackEnabled, uint32_t dupAckCount,
                       uint32_t bytesInFlight, uint32_t lastDeliveredBytes);
virtual void ExitRecovery (Ptr<TcpSocketState> tcb, uint32_t bytesInFlight);
virtual void UpdateBytesSent (uint32_t bytesSent);
virtual Ptr<TcpRecoveryOps> Fork ();
```

EnterRecovery is called when packet loss is detected and recovery is triggered. While in recovery phase, each time when an ACK arrives, DoRecovery is called which performs the necessary congestion window changes as per the recovery algorithm. ExitRecovery is called just prior to exiting recovery phase in order to perform the required congestion window adjustments. UpdateBytesSent is used to keep track of bytes sent and is called whenever a data packet is sent during recovery phase.

## Delivery Rate Estimation

Current TCP implementation measures the approximate value of the delivery rate of inflight data based on Delivery Rate Estimation.

As high level idea, keep in mind that the algorithm keeps track of 2 variables:

1. *delivered*: Total amount of data delivered so far.
2. *deliveredStamp*: Last time *delivered* was updated.

When a packet is transmitted, the value of *delivered* ( $d_0$ ) and *deliveredStamp* ( $t_0$ ) is stored in its respective TcpTxItem.

When an acknowledgement comes for this packet, the value of *delivered* and *deliveredStamp* is updated to  $d_1$  and  $t_1$  in the same TcpTxItem.

After processing the acknowledgement, the rate sample is calculated and then passed to a congestion avoidance algorithm:

$$delivery\_rate = (d_1 - d_0) / (t_1 - t_0)$$

The implementation to estimate delivery rate is a joint work between TcpTxBuffer and TcpRateOps. For more information, please take a look at their Doxygen documentation.

The implementation follows the Internet draft (Delivery Rate Estimation): <https://tools.ietf.org/html/draft-cheng-iccr-g-delivery-rate-estimation-00>

## Current limitations

- TcpCongestionOps interface does not contain every possible Linux operation

## Writing TCP tests

The TCP subsystem supports automated test cases on both socket functions and congestion control algorithms. To show how to write tests for TCP, here we explain the process of creating a test case that reproduces the [Bug #1571](#).

The bug concerns the zero window situation, which happens when the receiver cannot handle more data. In this case, it advertises a zero window, which causes the sender to pause transmission and wait for the receiver to increase the window.



The sender has a timer to periodically check the receiver's window: however, in modern TCP implementations, when the receiver has freed a "significant" amount of data, the receiver itself sends an "active" window update, meaning that the transmission could be resumed. Nevertheless, the sender timer is still necessary because window updates can be lost.

---

**Note:** During the text, we will assume some knowledge about the general design of the TCP test infrastructure, which is explained in detail into the Doxygen documentation. As a brief summary, the strategy is to have a class that sets up a TCP connection, and that calls protected members of itself. In this way, subclasses can implement the necessary members, which will be called by the main `TcpGeneralTest` class when events occur. For example, after processing an ACK, the method `ProcessedAck` will be invoked. Subclasses interested in checking some particular things which must have happened during an ACK processing, should implement the `ProcessedAck` method and check the interesting values inside the method. To get a list of available methods, please check the Doxygen documentation.

---

We describe the writing of two test cases, covering both situations: the sender's zero-window probing and the receiver "active" window update. Our focus will be on dealing with the reported problems, which are:

- an ns-3 receiver does not send "active" window update when its receive buffer is being freed;
- even if the window update is artificially crafted, the transmission does not resume.

However, other things should be checked in the test:

- Persistent timer setup
- Persistent timer teardown if `rWnd` increases

To construct the test case, one first derives from the `TcpGeneralTest` class:

The code is the following:

```
TcpZeroWindowTest::TcpZeroWindowTest (const std::string &desc)
    : TcpGeneralTest (desc)
{
}
```

Then, one should define the general parameters for the TCP connection, which will be one-sided (one node is acting as SENDER, while the other is acting as RECEIVER):

- Application packet size set to 500, and 20 packets in total (meaning a stream of 10k bytes)
- Segment size for both SENDER and RECEIVER set to 500 bytes
- Initial slow start threshold set to `UINT32_MAX`
- Initial congestion window for the SENDER set to 10 segments (5000 bytes)
- Congestion control: NewReno

We have also to define the link properties, because the above definition does not work for every combination of propagation delay and sender application behavior.

- Link one-way propagation delay: 50 ms
- Application packet generation interval: 10 ms
- Application starting time: 20 s after the starting point

To define the properties of the environment (e.g. properties which should be set before the object creation, such as propagation delay) one next implements the method `ConfigureEnvironment`:

```
void
TcpZeroWindowTest::ConfigureEnvironment ()
{
    TcpGeneralTest::ConfigureEnvironment ();
    SetAppPktCount (20);
    SetMTU (500);
    SetTransmitStart (Seconds (2.0));
    SetPropagationDelay (Milliseconds (50));
}
```

For other properties, set after the object creation, one can use `ConfigureProperties ()`. The difference is that some values, such as initial congestion window or initial slow start threshold, are applicable only to a single instance, not to every instance we have. Usually, methods that requires an id and a value are meant to be called inside `ConfigureProperties ()`. Please see the Doxygen documentation for an exhaustive list of the tunable properties.

```
void
TcpZeroWindowTest::ConfigureProperties ()
{
    TcpGeneralTest::ConfigureProperties ();
    SetInitialCwnd (SENDER, 10);
}
```

To see the default value for the experiment, please see the implementation of both methods inside `TcpGeneralTest` class.

---

**Note:** If some configuration parameters are missing, add a method called “SetSomeValue” which takes as input the value only (if it is meant to be called inside `ConfigureEnvironment`) or the socket and the value (if it is meant to be called inside `ConfigureProperties`).

---

To define a zero-window situation, we choose (by design) to initiate the connection with a 0-byte rx buffer. This implies that the RECEIVER, in its first SYN-ACK, advertises a zero window. This can be accomplished by implementing the method `CreateReceiverSocket`, setting an Rx buffer value of 0 bytes (at line 6 of the following code):

```
1 Ptr<TcpSocketMsgBase>
2 TcpZeroWindowTest::CreateReceiverSocket (Ptr<Node> node)
3 {
4     Ptr<TcpSocketMsgBase> socket = TcpGeneralTest::CreateReceiverSocket (node);
5
6     socket->SetAttribute ("RcvBufSize", UintegerValue (0));
7     Simulator::Schedule (Seconds (10.0),
8                          &TcpZeroWindowTest::IncreaseBufSize, this);
9
10    return socket;
11 }
```

Even so, to check the active window update, we should schedule an increase of the buffer size. We do this at line 7 and 8, scheduling the function `IncreaseBufSize`.

```
void
TcpZeroWindowTest::IncreaseBufSize ()
{
    SetRcvBufSize (RECEIVER, 2500);
}
```

Which utilizes the `SetRcvBufSize` method to edit the `RxBuffer` object of the RECEIVER. As said before, check the Doxygen documentation for class `TcpGeneralTest` to be aware of the various possibilities that it offers.

**Note:** By design, we choose to maintain a close relationship between `TcpSocketBase` and `TcpGeneralTest`: they are connected by a friendship relation. Since friendship is not passed through inheritance, if one discovers that one needs to access or to modify a private (or protected) member of `TcpSocketBase`, one can do so by adding a method in the class `TcpGeneralSocket`. An example of such method is `SetRcvBufSize`, which allows `TcpGeneralSocket` subclasses to forcefully set the `RxBuffer` size.

```
void
TcpGeneralTest::SetRcvBufSize (SocketWho who, uint32_t size)
{
    if (who == SENDER)
    {
        m_senderSocket->SetRcvBufSize (size);
    }
    else if (who == RECEIVER)
    {
        m_receiverSocket->SetRcvBufSize (size);
    }
    else
    {
        NS_FATAL_ERROR ("Not defined");
    }
}
```

Next, we can start to follow the TCP connection:

1. At time 0.0 s the connection is opened sender side, with a SYN packet sent from SENDER to RECEIVER
2. At time 0.05 s the RECEIVER gets the SYN and replies with a SYN-ACK
3. At time 0.10 s the SENDER gets the SYN-ACK and replies with a SYN.

While the general structure is defined, and the connection is started, we need to define a way to check the `rWnd` field on the segments. To this aim, we can implement the methods `Rx` and `Tx` in the `TcpGeneralTest` subclass, checking each time the actions of the RECEIVER and the SENDER. These methods are defined in `TcpGeneralTest`, and they are attached to the `Rx` and `Tx` traces in the `TcpSocketBase`. One should write small tests for every detail that one wants to ensure during the connection (it will prevent the test from changing over the time, and it ensures that the behavior will stay consistent through releases). We start by ensuring that the first SYN-ACK has 0 as advertised window size:

```
void
TcpZeroWindowTest::Tx(const Ptr<const Packet> p, const TcpHeader &h, SocketWho who)
{
    ...
    else if (who == RECEIVER)
    {
        NS_LOG_INFO ("\tRECEIVER TX " << h << " size " << p->GetSize());

        if (h.GetFlags () & TcpHeader::SYN)
        {
            NS_TEST_ASSERT_MSG_EQ (h.GetWindowSize(), 0,
                                   "RECEIVER window size is not 0 in the SYN-ACK");
        }
    }
    ....
}
```

Practically, we are checking that every SYN packet sent by the RECEIVER has the advertised window set to 0. The same thing is done also by checking, in the `Rx` method, that each SYN received by SENDER has the advertised

window set to 0. Thanks to the log subsystem, we can print what is happening through messages. If we run the experiment, enabling the logging, we can see the following:

```
./waf shell
gdb --args ./build/utils/ns3-dev-test-runner-debug --test-name=tcp-zero-window-test --
↳stop-on-failure --fullness=QUICK --assert-on-failure --verbose
(gdb) run

0.00s TcpZeroWindowTestSuite:Tx(): 0.00      SENDER TX 49153 > 4477 [SYN] Seq=0 Ack=0,
↳Win=32768 ns3::TcpOptionWinScale(2) ns3::TcpOptionTS(0;0) size 36
0.05s TcpZeroWindowTestSuite:Rx(): 0.05      RECEIVER RX 49153 > 4477 [SYN] Seq=0,
↳Ack=0 Win=32768 ns3::TcpOptionWinScale(2) ns3::TcpOptionTS(0;0)
↳ns3::TcpOptionEnd(EOL) size 0
0.05s TcpZeroWindowTestSuite:Tx(): 0.05      RECEIVER TX 4477 > 49153 [SYN|ACK] Seq=0,
↳Ack=1 Win=0 ns3::TcpOptionWinScale(0) ns3::TcpOptionTS(50;0) size 36
0.10s TcpZeroWindowTestSuite:Rx(): 0.10      SENDER RX 4477 > 49153 [SYN|ACK] Seq=0,
↳Ack=1 Win=0 ns3::TcpOptionWinScale(0) ns3::TcpOptionTS(50;0) ns3::TcpOptionEnd(EOL)
↳size 0
0.10s TcpZeroWindowTestSuite:Tx(): 0.10      SENDER TX 49153 > 4477 [ACK] Seq=1 Ack=1,
↳Win=32768 ns3::TcpOptionTS(100;50) size 32
0.15s TcpZeroWindowTestSuite:Rx(): 0.15      RECEIVER RX 49153 > 4477 [ACK] Seq=1,
↳Ack=1 Win=32768 ns3::TcpOptionTS(100;50) ns3::TcpOptionEnd(EOL) size 0
(...)
```

The output is cut to show the three-way handshake. As we can see from the headers, the rWnd of RECEIVER is set to 0, and thankfully our tests are not failing. Now we need to test for the persistent timer, which should be started by the SENDER after it receives the SYN-ACK. Since the Rx method is called before any computation on the received packet, we should utilize another method, namely ProcessedAck, which is the method called after each processed ACK. In the following, we show how to check if the persistent event is running after the processing of the SYN-ACK:

```
void
TcpZeroWindowTest::ProcessedAck (const Ptr<const TcpSocketState> tcb,
                                const TcpHeader& h, SocketWho who)
{
    if (who == SENDER)
    {
        if (h.GetFlags () & TcpHeader::SYN)
        {
            EventId persistentEvent = GetPersistentEvent (SENDER);
            NS_TEST_ASSERT_MSG_EQ (persistentEvent.IsRunning (), true,
                                  "Persistent event not started");
        }
    }
}
```

Since we programmed the increase of the buffer size after 10 simulated seconds, we expect the persistent timer to fire before any rWnd changes. When it fires, the SENDER should send a window probe, and the receiver should reply reporting again a zero window situation. At first, we investigate on what the sender sends:

```
1  if (Simulator::Now ().GetSeconds () <= 6.0)
2  {
3      NS_TEST_ASSERT_MSG_EQ (p->GetSize () - h.GetSerializedSize(), 0,
4                              "Data packet sent anyway");
5  }
6  else if (Simulator::Now ().GetSeconds () > 6.0 &&
7           Simulator::Now ().GetSeconds () <= 7.0)
8  {
```

(continues on next page)

(continued from previous page)

```

9     NS_TEST_ASSERT_MSG_EQ (m_zeroWindowProbe, false, "Sent another probe");
10
11     if (! m_zeroWindowProbe)
12     {
13         NS_TEST_ASSERT_MSG_EQ (p->GetSize () - h.GetSerializedSize(), 1,
14                               "Data packet sent instead of window probe");
15         NS_TEST_ASSERT_MSG_EQ (h.GetSequenceNumber(), SequenceNumber32 (1),
16                               "Data packet sent instead of window probe");
17         m_zeroWindowProbe = true;
18     }
19 }

```

We divide the events by simulated time. At line 1, we check everything that happens before the 6.0 seconds mark; for instance, that no data packets are sent, and that the state remains OPEN for both sender and receiver.

Since the persist timeout is initialized at 6 seconds (exercise left for the reader: edit the test, getting this value from the Attribute system), we need to check (line 6) between 6.0 and 7.0 simulated seconds that the probe is sent. Only one probe is allowed, and this is the reason for the check at line 11.

```

1  if (Simulator::Now ().GetSeconds () > 6.0 &&
2      Simulator::Now ().GetSeconds () <= 7.0)
3  {
4      NS_TEST_ASSERT_MSG_EQ (h.GetSequenceNumber(), SequenceNumber32 (1),
5                            "Data packet sent instead of window probe");
6      NS_TEST_ASSERT_MSG_EQ (h.GetWindowSize(), 0,
7                            "No zero window advertised by RECEIVER");
8  }

```

For the RECEIVER, the interval between 6 and 7 seconds is when the zero-window segment is sent.

Other checks are redundant; the safest approach is to deny any other packet exchange between the 7 and 10 seconds mark.

```

else if (Simulator::Now ().GetSeconds () > 7.0 &&
         Simulator::Now ().GetSeconds () < 10.0)
{
    NS_FATAL_ERROR ("No packets should be sent before the window update");
}

```

The state checks are performed at the end of the methods, since they are valid in every condition:

```

NS_TEST_ASSERT_MSG_EQ (GetCongStateFrom (GetTcb(SENDER)), TcpSocketState::CA_OPEN,
                      "Sender State is not OPEN");
NS_TEST_ASSERT_MSG_EQ (GetCongStateFrom (GetTcb(RECEIVER)), TcpSocketState::CA_OPEN,
                      "Receiver State is not OPEN");

```

Now, the interesting part in the Tx method is to check that after the 10.0 seconds mark (when the RECEIVER sends the active window update) the value of the window should be greater than zero (and precisely, set to 2500):

```

else if (Simulator::Now ().GetSeconds () >= 10.0)
{
    NS_TEST_ASSERT_MSG_EQ (h.GetWindowSize(), 2500,
                          "Receiver window not updated");
}

```

To be sure that the sender receives the window update, we can use the Rx method:

```
1  if (Simulator::Now().GetSeconds() >= 10.0)
2  {
3      NS_TEST_ASSERT_MSG_EQ (h.GetWindowSize(), 2500,
4                          "Receiver window not updated");
5      m_windowUpdated = true;
6  }
```

We check every packet after the 10 seconds mark to see if it has the window updated. At line 5, we also set to true a boolean variable, to check that we effectively reach this test.

Last but not least, we implement also the `NormalClose()` method, to check that the connection ends with a success:

```
void
TcpZeroWindowTest::NormalClose (SocketWho who)
{
    if (who == SENDER)
    {
        m_senderFinished = true;
    }
    else if (who == RECEIVER)
    {
        m_receiverFinished = true;
    }
}
```

The method is called only if all bytes are transmitted successfully. Then, in the method `FinalChecks()`, we check all variables, which should be true (which indicates that we have perfectly closed the connection).

```
void
TcpZeroWindowTest::FinalChecks ()
{
    NS_TEST_ASSERT_MSG_EQ (m_zeroWindowProbe, true,
                          "Zero window probe not sent");
    NS_TEST_ASSERT_MSG_EQ (m_windowUpdated, true,
                          "Window has not updated during the connection");
    NS_TEST_ASSERT_MSG_EQ (m_senderFinished, true,
                          "Connection not closed successfully (SENDER)");
    NS_TEST_ASSERT_MSG_EQ (m_receiverFinished, true,
                          "Connection not closed successfully (RECEIVER)");
}
```

To run the test, the usual way is

```
./test.py -s tcp-zero-window-test

PASS: TestSuite tcp-zero-window-test
1 of 1 tests passed (1 passed, 0 skipped, 0 failed, 0 crashed, 0 valgrind errors)
```

To see INFO messages, use a combination of `./waf shell` and `gdb` (really useful):

```
./waf shell && gdb --args ./build/utils/ns3-dev-test-runner-debug --test-name=tcp-
↪zero-window-test --stop-on-failure --fullness=QUICK --assert-on-failure --verbose
```

and then, hit “Run”.

---

**Note:** This code magically runs without any reported errors; however, in real cases, when you discover a bug you should expect the existing test to fail (this could indicate a well-written test and a bad-written model, or a bad-written

test; hopefully the first situation). Correcting bugs is an iterative process. For instance, commits created to make this test case running without errors are 11633:6b74df04cf44, (others to be merged).

### 17.5.3 Network Simulation Cradle

The [Network Simulation Cradle \(NSC\)](#) is a framework for wrapping real-world network code into simulators, allowing simulation of real-world behavior at little extra cost. This work has been validated by comparing situations using a test network with the same situations in the simulator. To date, it has been shown that the NSC is able to produce extremely accurate results. NSC supports four real world stacks: FreeBSD, OpenBSD, lwIP and Linux. Emphasis has been placed on not changing any of the network stacks by hand. Not a single line of code has been changed in the network protocol implementations of any of the above four stacks. However, a custom C parser was built to programmatically change source code.

NSC has previously been ported to *ns-2* and OMNeT++, and was added to *ns-3* in September 2008 (ns-3.2 release). This section describes the *ns-3* port of NSC and how to use it.

NSC has been obsoleted by the Linux kernel support within [Direct Code Execution \(DCE\)](#). However, NSC is still available through the bake build system. NSC supports Linux kernels 2.6.18 and 2.6.26, and an experimental version of 2.6.29 exists on ns-3's code server (<http://code.nsnam.org/fw/nsc-linux-2.6.29/>), but newer versions of the kernel have not been ported.

#### Prerequisites

Presently, NSC has been tested and shown to work on these platforms: Linux i386 and Linux x86-64. NSC does not support powerpc. Use on FreeBSD or OS X is unsupported (although it may be able to work).

Building NSC requires the packages flex and bison.

NSC requires use of gcc-4.9 or gcc-5 series, and will not build on newer systems lacking the older compilers.

#### Configuring and Downloading

NSC must either be downloaded separately from its own repository, or downloading when using the [bake build system](#) of *ns-3*.

For ns-3.17 through ns-3.28 releases, when using bake, one obtains NSC implicitly as part of an “allinone” configuration, such as:

```
$ cd bake
$ python bake.py configure -e ns-allinone-3.27
$ python bake.py download
$ python bake.py build
```

For ns-3.29 and later versions, including the ‘ns-3-allinone’ development version, one must explicitly add NSC (‘nsc-0.5.3’) to the bake configuration, such as:

```
$ cd bake
$ python bake.py configure -e ns-allinone-3.29 -e nsc-0.5.3
$ python bake.py download
$ python bake.py build
```

Instead of a released version, one may use the ns-3 development version by specifying “ns-3-allinone” to the configure step above.

NSC may also be downloaded from [its download site](#) using Mercurial:

```
$ hg clone https://secure.wand.net.nz/mercurial/nsc
```

Prior to the ns-3.17 release, NSC was included in the allinone tarball and the released version did not need to be separately downloaded.

### Building and validating

NSC may be built as part of the bake build process; alternatively, one may build NSC by itself using its build system; e.g.:

```
$ cd nsc-dev
$ python sconscript.py
```

Once NSC has been built either manually or through the bake system, change into the *ns-3* source directory and try running the following configuration:

```
$ ./waf configure
```

If NSC has been previously built and found by waf, then you will see:

```
Network Simulation Cradle      : enabled
```

If NSC has not been found, you will see:

```
Network Simulation Cradle      : not enabled (NSC not found (see option --with-nsc))
```

In this case, you must pass the relative or absolute path to the NSC libraries with the “`--with-nsc`” configure option; e.g.

```
$ ./waf configure --with-nsc=/path/to/my/nsc/directory
```

For *ns-3* releases prior to the ns-3.17 release, using the `build.py` script in `ns-3-allinone` directory, NSC will be built by default unless the platform does not support it. To explicitly disable it when building *ns-3*, type:

```
$ ./waf configure --enable-examples --enable-tests --disable-nsc
```

If waf detects NSC, then building *ns-3* with NSC is performed the same way with waf as without it. Once *ns-3* is built, try running the following test suite:

```
$ ./test.py -s ns3-tcp-interoperability
```

If NSC has been successfully built, the following test should show up in the results:

```
PASS TestSuite ns3-tcp-interoperability
```

This confirms that NSC is ready to use.

### Usage

There are a few example files. Try:

```
$ ./waf --run tcp-nsc-zoo
$ ./waf --run tcp-nsc-lfn
```



These examples will deposit some `.pcap` files in your directory, which can be examined by `tcpdump` or `wireshark`.

Let's look at the `examples/tcp/tcp-nsc-zoo.cc` file for some typical usage. How does it differ from using native `ns-3` TCP? There is one main configuration line, when using NSC and the `ns-3` helper API, that needs to be set:

```
InternetStackHelper internetStack;

internetStack.SetNscStack ("liblinux2.6.26.so");
// this switches nodes 0 and 1 to NSCs Linux 2.6.26 stack.
internetStack.Install (n.Get(0));
internetStack.Install (n.Get(1));
```

The key line is the `SetNscStack`. This tells the `InternetStack` helper to aggregate instances of NSC TCP instead of native `ns-3` TCP to the remaining nodes. It is important that this function be called **before** calling the `Install()` function, as shown above.

Which stacks are available to use? Presently, the focus has been on Linux 2.6.18 and Linux 2.6.26 stacks for `ns-3`. To see which stacks were built, one can execute the following `find` command at the `ns-3` top level directory:

```
$ find nsc -name "*.so" -type f
nsc/linux-2.6.18/liblinux2.6.18.so
nsc/linux-2.6.26/liblinux2.6.26.so
```

This tells us that we may either pass the library name `liblinux2.6.18.so` or `liblinux2.6.26.so` to the above configuration step.

## Stack configuration

NSC TCP shares the same configuration attributes that are common across TCP sockets, as described above and documented in [Doxygen](#)

Additionally, NSC TCP exports a lot of configuration variables into the `ns-3` attributes system, via a `sysctl`-like interface. In the `examples/tcp/tcp-nsc-zoo` example, you can see the following configuration:

```
// this disables TCP SACK, wscale and timestamps on node 1 (the attributes
// represent sysctl-values).
Config::Set ("/NodeList/1/$ns3::Ns3NscStack<linux2.6.26>/net.ipv4.tcp_sack",
             StringValue ("0"));
Config::Set ("/NodeList/1/$ns3::Ns3NscStack<linux2.6.26>/net.ipv4.tcp_timestamps",
             StringValue ("0"));
Config::Set ("/NodeList/1/$ns3::Ns3NscStack<linux2.6.26>/net.ipv4.tcp_window_scaling",
             StringValue ("0"));
```

These additional configuration variables are not available to native `ns-3` TCP.

Also note that default values for TCP attributes in `ns-3` TCP may differ from the NSC TCP implementation. Specifically in `ns-3`:

- 1) TCP default MSS is 536
- 2) TCP Delayed ACK count is 2

Therefore when making comparisons between results obtained using NSC and `ns-3` TCP, care must be taken to ensure these values are set appropriately. See `/examples/tcp/tcp-nsc-comparison.cc` for an example.

## NSC API

This subsection describes the API that NSC presents to *ns-3* or any other simulator. NSC provides its API in the form of a number of classes that are defined in `sim/sim_interface.h` in the `nsc` directory.

- **INetStack** INetStack contains the ‘low level’ operations for the operating system network stack, e.g. in and output functions from and to the network stack (think of this as the ‘network driver interface’). There are also functions to create new TCP or UDP sockets.
- **ISendCallback** This is called by NSC when a packet should be sent out to the network. This simulator should use this callback to re-inject the packet into the simulator so the actual data can be delivered/routed to its destination, where it will eventually be handed into `Receive()` (and eventually back to the receivers NSC instance via `INetStack->if_receive()`).
- **INetStreamSocket** This is the structure defining a particular connection endpoint (file descriptor). It contains methods to operate on this endpoint, e.g. `connect`, `disconnect`, `accept`, `listen`, `send_data/read_data`, ...
- **IInterruptCallback** This contains the `wakeup()` callback, which is called by NSC whenever something of interest happens. Think of `wakeup()` as a replacement of the operating systems `wakeup` function: Whenever the operating system would wake up a process that has been waiting for an operation to complete (for example the TCP handshake during `connect()`), NSC invokes the `wakeup()` callback to allow the simulator to check for state changes in its connection endpoints.

## ns-3 implementation

The *ns-3* implementation makes use of the above NSC API, and is implemented as follows.

The three main parts are:

- `ns3::NscTcpL4Protocol`: a subclass of `Ipv4L4Protocol` (and two NSC classes: `ISendCallback` and `IInterruptCallback`)
- `ns3::NscTcpSocketImpl`: a subclass of `TcpSocket`
- `ns3::NscTcpSocketFactoryImpl`: a factory to create new NSC sockets

`src/internet/model/nsc-tcp-l4-protocol` is the main class. Upon Initialization, it loads an NSC network stack to use (via `dlopen()`). Each instance of this class may use a different stack. The stack (=shared library) to use is set using the `SetNscLibrary()` method (at this time its called indirectly via the internet stack helper). The NSC stack is then set up accordingly (timers etc). The `NscTcpL4Protocol::Receive()` function hands the packet it receives (must be a complete TCP/IP packet) to the NSC stack for further processing. To be able to send packets, this class implements the NSC `send_callback()` method. This method is called by NSC whenever the NSC stack wishes to send a packet out to the network. Its arguments are a raw buffer, containing a complete TCP/IP packet, and a length value. This method therefore has to convert the raw data to a `Ptr<Packet>` usable by *ns-3*. In order to avoid various IPv4 header issues, the NSC IP header is not included. Instead, the TCP header and the actual payload are put into the `Ptr<Packet>`, after this the `Packet` is passed down to layer 3 for sending the packet out (no further special treatment is needed in the send code path).

This class calls `ns3::NscTcpSocketImpl` both from the NSC `wakeup()` callback and from the receive path (to ensure that possibly queued data is scheduled for sending).

`src/internet/model/nsc-tcp-socket-impl` implements the NSC socket interface. Each instance has its own `m_nscTcpSocket`. Data that is sent will be handed to the NSC stack via `m_nscTcpSocket->send_data()` (and not to `NscTcpL4Protocol`, this is the major difference compared to *ns-3* TCP). The class also queues up data that is sent before the underlying descriptor has entered an ESTABLISHED state. This class is called from the `NscTcpL4Protocol` class, when the `NscTcpL4Protocol wakeup()` callback is invoked by NSC. `NscTcpSocketImpl` then checks the current connection state (`SYN_SENT`, `ESTABLISHED`, `LISTEN`...) and schedules appropriate callbacks as needed, e.g. a `LISTEN` socket will schedule `accept()` to see if a new connection must be accepted, an `ESTABLISHED` socket schedules any pending data for writing, schedule a `read()` callback, etc.

Note that `ns3::NscTcpSocketImpl` does not interact with NSC TCP directly: instead, data is redirected to NSC. NSC TCP calls the NSC TCP sockets of a node when its `wakeup()` callback is invoked by NSC.

## Limitations

- NSC only works on single-interface nodes; attempting to run it on a multi-interface node will cause a program error.
- Cygwin and OS X PPC are not supported; OS X Intel is not supported but may work
- The non-Linux stacks of NSC are not supported in *ns-3*
- Not all socket API callbacks are supported

For more information, see [this wiki page](#).

## 17.6 UDP model in ns-3

This chapter describes the UDP model available in *ns-3*.

### 17.6.1 Generic support for UDP

*ns-3* supports a native implementation of UDP. It provides a connectionless, unreliable datagram packet service. Packets may be reordered or duplicated before they arrive. UDP calculates and checks checksums to catch transmission errors.

This implementation inherits from a few common header classes in the `src/network` directory, so that user code can swap out implementations with minimal changes to the scripts.

Here are the important abstract base classes:

- `class UdpSocket`: This is defined in: `src/internet/model/udp-socket.{cc,h}` This is an abstract base class of all UDP sockets. This class exists solely for hosting `UdpSocket` attributes that can be reused across different implementations, and for declaring UDP-specific multicast API.
- `class UdpSocketImpl`: This class subclasses `UdpSocket`, and provides a socket interface to *ns-3*'s implementation of UDP.
- `class UdpSocketFactory`: This is used by the layer-4 protocol instance to create UDP sockets.
- `class UdpSocketFactoryImpl`: This class is derived from `SocketFactory` and implements the API for creating UDP sockets.
- `class UdpHeader`: This class contains fields corresponding to those in a network UDP header (port numbers, payload size, checksum) as well as methods for serialization to and deserialization from a byte buffer.
- `class UdpL4Protocol`: This is a subclass of `IpL4Protocol` and provides an implementation of the UDP protocol.

### 17.6.2 ns-3 UDP

This is an implementation of the User Datagram Protocol described in RFC 768. UDP uses a simple connectionless communication model with a minimum of protocol mechanism. The implementation provides checksums for data integrity, and port numbers for addressing different functions at the source and destination of the datagram. It has no handshaking dialogues, and thus exposes the user's data to any unreliability of the underlying network. There is no guarantee of data delivery, ordering, or duplicate protection.

## Usage

In many cases, usage of UDP is set at the application layer by telling the *ns-3* application which kind of socket factory to use.

Using the helper functions defined in `src/applications/helper`, here is how one would create a UDP receiver:

```
// Create a packet sink on the receiver
uint16_t port = 50000;
Address sinkLocalAddress(InetSocketAddress (Ipv4Address::GetAny (), port));
PacketSinkHelper sinkHelper ("ns3::UdpSocketFactory", sinkLocalAddress);
ApplicationContainer sinkApp = sinkHelper.Install (serverNode);
sinkApp.Start (Seconds (1.0));
sinkApp.Stop (Seconds (10.0));
```

Similarly, the below snippet configures OnOffApplication traffic source to use UDP:

```
// Create the OnOff applications to send data to the UDP receiver
OnOffHelper clientHelper ("ns3::UdpSocketFactory", Address ());
clientHelper.SetAttribute ("Remote", remoteAddress);
ApplicationContainer clientApps = (clientHelper.Install (clientNode));
clientApps.Start (Seconds (2.0));
clientApps.Stop (Seconds (9.0));
```

For users who wish to have a pointer to the actual socket (so that socket operations like `Bind()`, setting socket options, etc. can be done on a per-socket basis), UDP sockets can be created by using the `Socket::CreateSocket()` method as given below:

```
Ptr<Node> node = CreateObject<Node> ();
InternetStackHelper internet;
internet.Install (node);

Ptr<SocketFactory> socketFactory = node->GetObject<UdpSocketFactory> ();
Ptr<Socket> socket = socketFactory->CreateSocket ();
socket->Bind (InetSocketAddress (Ipv4Address::GetAny (), 80));
```

Once a UDP socket is created, we do not need an explicit connection setup before sending and receiving data. Being a connectionless protocol, all we need to do is to create a socket and bind it to a known port. For a client, simply create a socket and start sending data. The `Bind()` call allows an application to specify a port number and an address on the local machine. It allocates a local IPv4 endpoint for this socket.

At the end of data transmission, the socket is closed using the `Socket::Close()`. It returns a 0 on success and -1 on failure.

Please note that applications usually create the sockets automatically. Please refer to the source code of your preferred application to discover how and when it creates the socket.

## UDP Socket interaction and interface with Application layer

The following is the description of the public interface of the UDP socket, and how the interface is used to interact with the socket itself.

### Socket APIs for UDP connections:

**Connect()** This is called when `Send()` is used instead of `SendTo()` by the user. It sets the address of the remote endpoint which is used by `Send()`. If the remote address is valid, this method makes a callback to *Connection-Succeeded*.

**Bind()** Bind the socket to an address, or to a general endpoint. A general endpoint is an endpoint with an ephemeral port allocation (that is, a random port allocation) on the 0.0.0.0 IP address. For instance, in current applications, data senders usually bind automatically after a `Connect()` over a random port. Consequently, the connection will start from this random port towards the well-defined port of the receiver. The IP 0.0.0.0 is then translated by lower layers into the real IP of the device.

**Bind6()** Same as `Bind()`, but for IPv6.

**BindToNetDevice()** Bind the socket to the specified `NetDevice`. If set on a socket, this option will force packets to leave the bound device regardless of the device that IP routing would naturally choose. In the receive direction, only packets received from the bound interface will be delivered.

**ShutdownSend()** Signals the termination of send, or in other words, prevents data from being added to the buffer.

**Recv()** Grabs data from the UDP socket and forwards it to the application layer. If no data is present (i.e. `m_deliveryQueue.empty()` returns 0), an empty packet is returned.

**RecvFrom()** Same as `Recv()`, but with the source address as parameter.

**SendTo()** The `SendTo()` API is the UDP counterpart of the TCP API `Send()`. It additionally specifies the address to which the message is to be sent because no prior connection is established in UDP communication. It returns the number of bytes sent or -1 in case of failure.

**Close()** The close API closes a socket and terminates the connection. This results in freeing all the data structures previously allocated.

---

## Public callbacks

These callbacks are called by the UDP socket to notify the application of interesting events. We will refer to these with the protected name used in `socket.h`, but we will provide the API function to set the pointers to these callback as well.

**NotifyConnectionSucceeded: SetConnectCallback, 1st argument** Called when the `Connect()` succeeds and the remote address is validated.

**NotifyConnectionFailed: SetConnectCallback, 2nd argument** Called in `Connect()` when the the remote address validation fails.

**NotifyDataSent: SetDataSentCallback** The socket notifies the application that some bytes have been transmitted at the IP layer. These bytes could still be lost in the node (traffic control layer) or in the network.

**NotifySend: SetSendCallback** Invoked to get the space available in the tx buffer when a packet (that carries data) is sent.

**NotifyDataRecv: SetRecvCallback** Called when the socket receives a packet (that carries data) in the receiver buffer.

## Validation

The following test cases have been provided for UDP implementation in the `src/internet/test/udp-test.cc` file.

- **UdpSocketImplTest:** Checks data received via UDP Socket over IPv4.
- **UdpSocketLoopbackTest:** Checks data received via UDP Socket Loopback over IPv4.
- **Udp6SocketImplTest :** Checks data received via UDP Socket over IPv6.
- **Udp6SocketLoopbackTest :** Checks data received via UDP Socket Loopback over IPv6 Test.

## Limitations

- UDP\_CORK is presently not the part of this implementation.
- `NotifyNormalClose`, `NotifyErrorClose`, `NotifyConnectionRequest` and `NotifyNewConnectionCreated` socket API callbacks are not supported.

## 17.7 Internet Applications Module Documentation

The goal of this module is to hold all the Internet-specific applications, and most notably some very specific applications (e.g., ping) or daemons (e.g., radvd). Other non-Internet-specific applications such as packet generators are contained in other modules.

The source code for the new module lives in the directory `src/internet-apps`.

Each application has its own goals, limitations and scope, which are briefly explained in the following.

All the applications are extensively used in the top-level `examples` directories. The users are encouraged to check the scripts therein to have a clear overview of the various options and usage tricks.

### 17.7.1 V4Ping

This app mimics a “ping” (ICMP Echo) using IPv4. The application allows the following attributes to be set:

- Remote address
- Verbose mode
- Packet size (default 56 bytes)
- Packet interval (default 1 second)

Moreover, the user can access the measured RTT value (as a Traced Source).

### 17.7.2 Ping6

This app mimics a “ping” (ICMP Echo) using IPv6. The application allows the following attributes to be set:

- Remote address
- Local address (sender address)
- Packet size (default 56 bytes)
- Packet interval (default 1 second)
- Max number of packets to send

### 17.7.3 Radvd

This app mimics a “RADVD” daemon. I.e., the daemon responsible for IPv6 routers advertisements. All the IPv6 routers should have a RADVD daemon installed.

The configuration of the Radvd application mimics the one of the radvd Linux program.

## 17.7.4 DHCPv4

The *ns-3* implementation of Dynamic Host Configuration Protocol (DHCP) follows the specifications of [RFC 2131](#) and [RFC 2132](#).

The source code for DHCP is located in `src/internet-apps/model` and consists of the following 6 files:

- `dhcp-server.h`,
- `dhcp-server.cc`,
- `dhcp-client.h`,
- `dhcp-client.cc`,
- `dhcp-header.h` and
- `dhcp-header.cc`

### Helpers

The following two files have been added to `src/internet-apps/helper` for DHCP:

- `dhcp-helper.h` and
- `dhcp-helper.cc`

### Tests

The tests for DHCP can be found at `src/internet-apps/test/dhcp-test.cc`

### Examples

The examples for DHCP can be found at `src/internet-apps/examples/dhcp-example.cc`

### Scope and Limitations

The server should be provided with a network address, mask and a range of address for the pool. One client application can be installed on only one netdevice in a node, and can configure address for only that netdevice.

The following five basic DHCP messages are supported:

- DHCP DISCOVER
- DHCP OFFER
- DHCP REQUEST
- DHCP ACK
- DHCP NACK

Also, the following eight options of BootP are supported:

- 1 (Mask)
- 50 (Requested Address)
- 51 (Address Lease Time)
- 53 (DHCP message type)

- 54 (DHCP server identifier)
- 58 (Address renew time)
- 59 (Address rebind time)
- 255 (end)

The client identifier option (61) can be implemented in near future.

In the current implementation, a DHCP client can obtain IPv4 address dynamically from the DHCP server, and can renew it within a lease time period.

Multiple DHCP servers can be configured, but the implementation does not support the use of a DHCP Relay yet.

PageBreak



## LOW-RATE WIRELESS PERSONAL AREA NETWORK (LR-WPAN)

This chapter describes the implementation of ns-3 models for the low-rate, wireless personal area network (LR-WPAN) as specified by IEEE standard 802.15.4 (2006).

### 18.1 Model Description

The source code for the lr-wpan module lives in the directory `src/lr-wpan`.

#### 18.1.1 Design

The model design closely follows the standard from an architectural standpoint.

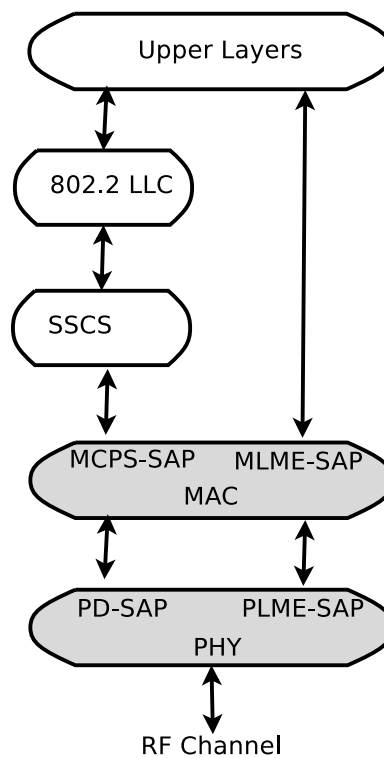

Fig. 1: Architecture and scope of Ir-wpan models

The grey areas in the figure (adapted from Fig 3. of IEEE Std. 802.15.4-2006) show the scope of the model.

The Spectrum NetDevice from Nicola Baldo is the basis for the implementation.

The implementation also plans to borrow from the ns-2 models developed by Zheng and Lee in the future.

## APIs

The APIs closely follow the standard, adapted for ns-3 naming conventions and idioms. The APIs are organized around the concept of service primitives as shown in the following figure adapted from Figure 14 of IEEE Std. 802.15.4-2006.

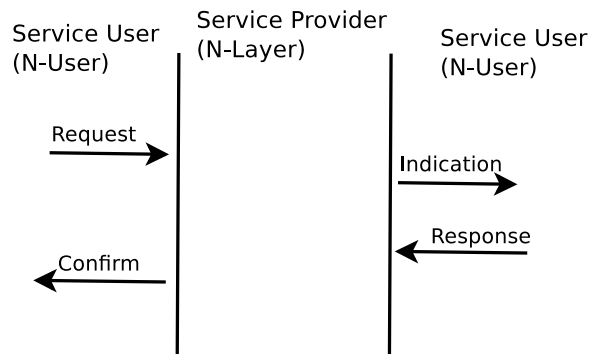

Fig. 2: Service primitives

The APIs are organized around four conceptual services and service access points (SAP):

- MAC data service (MCPS)
- MAC management service (MLME)
- PHY data service (PD)
- PHY management service (PLME)

In general, primitives are standardized as follows (e.g. Sec 7.1.1.1.1 of IEEE 802.15.4-2006)::

```
MCPS-DATA.request      (
    SrcAddrMode,
    DstAddrMode,
    DstPANId,
    DstAddr,
    msduLength,
    msdu,
    msduHandle,
    TxOptions,
    SecurityLevel,
    KeyIdMode,
    KeySource,
    KeyIndex
)
```

This maps to ns-3 classes and methods such as::

```
struct McpsDataRequestParameters
{
    uint8_t m_srcAddrMode;
    uint8_t m_dstAddrMode;
    ...
}
```

(continues on next page)

(continued from previous page)

```
};

void
LrWpanMac::McpsDataRequest (McpsDataRequestParameters params)
{
...
}
```

## MAC

The MAC at present implements the unslotted CSMA/CA variant, without beaconing. Currently there is no support for coordinators and the relevant APIs.

The implemented MAC is similar to Contiki's NullMAC, i.e., a MAC without sleep features. The radio is assumed to be always active (receiving or transmitting), or completely shut down. Frame reception is not disabled while performing the CCA.

The main API supported is the data transfer API (McpsDataRequest/Indication/Confirm). CSMA/CA according to Std 802.15.4-2006, section 7.5.1.4 is supported. Frame reception and rejection according to Std 802.15.4-2006, section 7.5.6.2 is supported, including acknowledgements. Only short addressing completely implemented. Various trace sources are supported, and trace sources can be hooked to sinks.

## PHY

The physical layer components consist of a Phy model, an error rate model, and a loss model. The error rate model presently models the error rate for IEEE 802.15.4 2.4 GHz AWGN channel for OQPSK; the model description can be found in IEEE Std 802.15.4-2006, section E.4.1.7. The Phy model is based on SpectrumPhy and it follows specification described in section 6 of IEEE Std 802.15.4-2006. It models PHY service specifications, PPDU formats, PHY constants and PIB attributes. It currently only supports the transmit power spectral density mask specified in 2.4 GHz per section 6.5.3.1. The noise power density assumes uniformly distributed thermal noise across the frequency bands. The loss model can fully utilize all existing simple (non-spectrum phy) loss models. The Phy model uses the existing single spectrum channel model. The physical layer is modeled on packet level, that is, no preamble/SFD detection is done. Packet reception will be started with the first bit of the preamble (which is not modeled), if the SNR is more than -5 dB, see IEEE Std 802.15.4-2006, appendix E, Figure E.2. Reception of the packet will finish after the packet was completely transmitted. Other packets arriving during reception will add up to the interference/noise.

Currently the receiver sensitivity is set to a fixed value of -106.58 dBm. This corresponds to a packet error rate of 1% for 20 byte reference packets for this signal power, according to IEEE Std 802.15.4-2006, section 6.1.7. In the future we will provide support for changing the sensitivity to different values.

## NetDevice

Although it is expected that other technology profiles (such as 6LoWPAN and ZigBee) will write their own NetDevice classes, a basic LrWpanNetDevice is provided, which encapsulates the common operations of creating a generic LrWpan device and hooking things together.

## MAC addresses

Contrary to other technologies, a IEEE 802.15.4 has 2 different kind of addresses:

- Long addresses (64 bits)

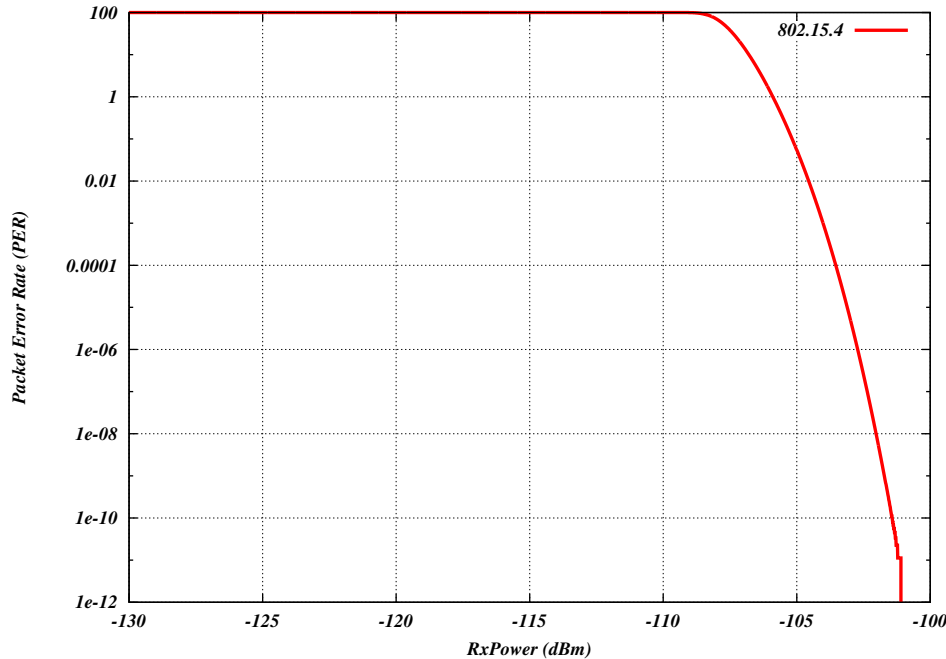

Fig. 3: Packet error rate vs. signal power

- Short addresses (16 bits)

The 64-bit addresses are unique worldwide, and set by the device vendor (in a real device). The 16-bit addresses are not guaranteed to be unique, and they are typically either assigned during the devices deployment, or assigned dynamically during the device bootstrap.

In **ns-3l** the device bootstrap is not (yet) present. Hence, both addresses are set when the device is created.

The other relevant “address” to consider is the PanId (16 bits), which represents the PAN the device is attached to.

Due to the limited number of available bytes in a packet, IEEE 802.15.4 tries to use short addresses instead of long addresses, even though the two might be used at the same time.

For the sake of communicating with the upper layers, and in particular to generate auto-configured IPv6 addresses, each NetDevice must identify itself with a MAC address. The MAC addresses are also used during packet reception, so it is important to use them consistently.

Focusing on IPv6 Stateless address autoconfiguration (SLAAC), there are two relevant RFCs to consider: RFC 4944 and RFC 6282, and the two differ on how to build the IPv6 address given the NetDevice address.

RFC 4944 mandates that the IID part of the IPv6 address is calculated as  $YYYY:00ff:fe00:XXXX$ , while RFC 6282 mandates that the IID part of the IPv6 address is calculated as  $0000:00ff:fe00:XXXX$  where  $XXXX$  is the device short address, and  $YYYY$  is the PanId. In both cases the U/L bit must be set to local, so in the RFC 4944 the PanId might have one bit flipped.

In order to facilitate interoperability, and to avoid unwanted module dependencies, the **ns-3l** implementation moves the IID calculation in the `LrWpanNetDevice::GetAddress()`, which will return an `Address` formatted properly, i.e.:

- The Long address (a `Mac64Address`) if the Short address has not been set, or
- A properly formatted 48-bit pseudo-address (a `Mac48Address`) if the short address has been set.

The 48-bit pseudo-address is generated according to either RFC 4944 or RFC 6282 depending on the configuration of an Attribute (`PseudoMacAddressMode`).

The default is to use RFC 6282 style addresses.

Note that, on reception, a packet might contain either a short or a long address. This is reflected in the upper-layer notification callback, which can contain either the pseudo-address (48 bits) or the long address (64 bit) of the sender.

Note also that RFC 4944 or RFC 6282 are the RFCs defining the IPv6 address compression formats (HC1 and IPHC respectively). It is definitely not a good idea to either mix devices using different pseudo-address format or compression types in the same network. This point is further discussed in the `sixlowpan` module documentation.

## 18.1.2 Scope and Limitations

Future versions of this document will contain a PICS proforma similar to Appendix D of IEEE 802.15.4-2006. The current emphasis is on the unslotted mode of 802.15.4 operation for use in Zigbee, and the scope is limited to enabling a single mode (CSMA/CA) with basic data transfer capabilities. Association with PAN coordinators is not yet supported, nor the use of extended addressing. Interference is modeled as AWGN but this is currently not thoroughly tested.

The NetDevice Tx queue is not limited, i.e., packets are never dropped due to queue becoming full. They may be dropped due to excessive transmission retries or channel access failure.

## 18.1.3 References

- Wireless Medium Access Control (MAC) and Physical Layer (PHY) Specifications for Low-Rate Wireless Personal Area Networks (WPANs), IEEE Computer Society, IEEE Std 802.15.4-2006, 8 September 2006.
- J. Zheng and Myung J. Lee, “A comprehensive performance study of IEEE 802.15.4,” Sensor Network Operations, IEEE Press, Wiley Interscience, Chapter 4, pp. 218-237, 2006.

## 18.2 Usage

### 18.2.1 Enabling lr-wpan

Add `lr-wpan` to the list of modules built with ns-3.

### 18.2.2 Helper

The helper is patterned after other device helpers. In particular, tracing (`ascii` and `pcap`) is enabled similarly, and enabling of all `lr-wpan` log components is performed similarly. Use of the helper is exemplified in `examples/lr-wpan-data.cc`. For `ascii` tracing, the transmit and receive traces are hooked at the Mac layer.

The default propagation loss model added to the channel, when this helper is used, is the `LogDistancePropagationLossModel` with default parameters.

### 18.2.3 Examples

The following examples have been written, which can be found in `src/lr-wpan/examples/`:

- `lr-wpan-data.cc`: A simple example showing end-to-end data transfer.
- `lr-wpan-error-distance-plot.cc`: An example to plot variations of the packet success ratio as a function of distance.
- `lr-wpan-error-model-plot.cc`: An example to test the phy.

- `lr-wpan-packet-print.cc`: An example to print out the MAC header fields.
- `lr-wpan-phy-test.cc`: An example to test the phy.

In particular, the module enables a very simplified end-to-end data transfer scenario, implemented in `lr-wpan-data.cc`. The figure shows a sequence of events that are triggered when the MAC receives a `DataRequest` from the higher layer. It invokes a Clear Channel Assessment (CCA) from the PHY, and if successful, sends the frame down to the PHY where it is transmitted over the channel and results in a `DataIndication` on the peer node.

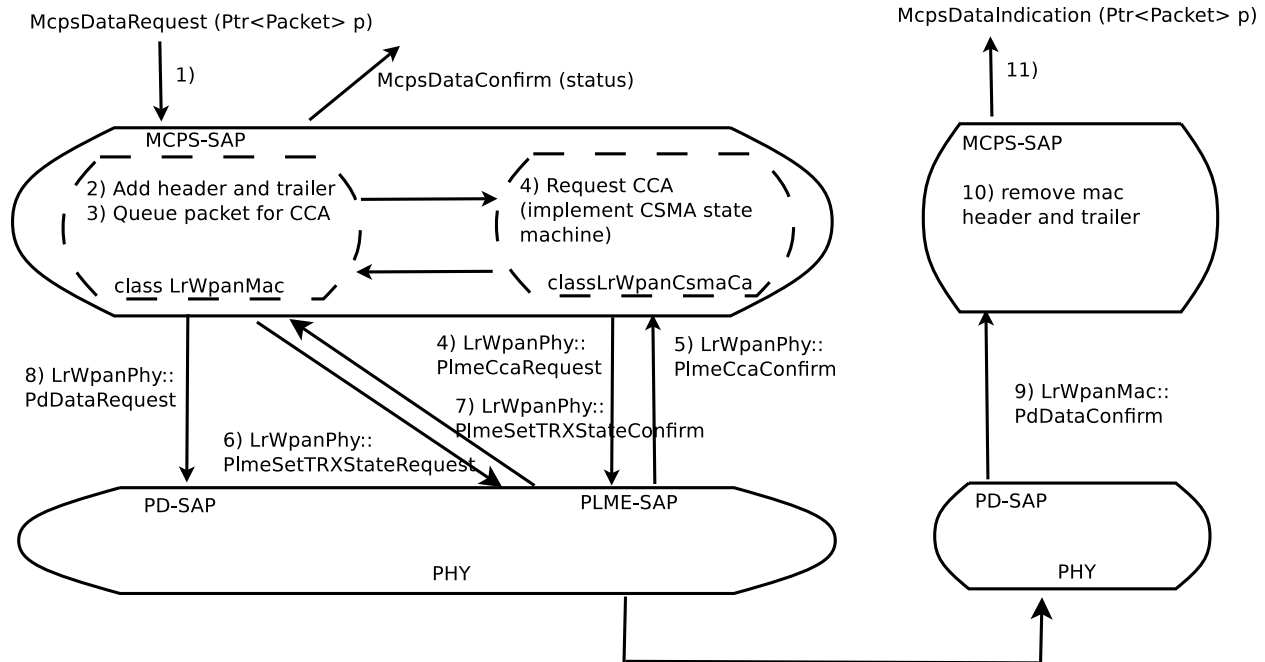

Fig. 4: Data example for simple LR-WPAN data transfer end-to-end

The example `lr-wpan-error-distance-plot.cc` plots the packet success ratio (PSR) as a function of distance, using the default `LogDistance` propagation loss model and the 802.15.4 error model. The channel (default 11), packet size (default 20 bytes) and transmit power (default 0 dBm) can be varied by command line arguments. The program outputs a file named `802.15.4-psr-distance.plt`. Loading this file into `gnuplot` yields a file `802.15.4-psr-distance.eps`, which can be converted to pdf or other formats. The default output is shown below.

### 18.2.4 Tests

The following tests have been written, which can be found in `src/lr-wpan/tests/`:

- `lr-wpan-ack-test.cc`: Check that acknowledgments are being used and issued in the correct order.
- `lr-wpan-collision-test.cc`: Test correct reception of packets with interference and collisions.
- `lr-wpan-error-model-test.cc`: Check that the error model gives predictable values.
- `lr-wpan-packet-test.cc`: Test the 802.15.4 MAC header/trailer classes
- `lr-wpan-pd-plme-sap-test.cc`: Test the PLME and PD SAP per IEEE 802.15.4
- `lr-wpan-spectrum-value-helper-test.cc`: Test that the conversion between power (expressed as a scalar quantity) and spectral power, and back again, falls within a 25% tolerance across the range of possible channels and input powers.

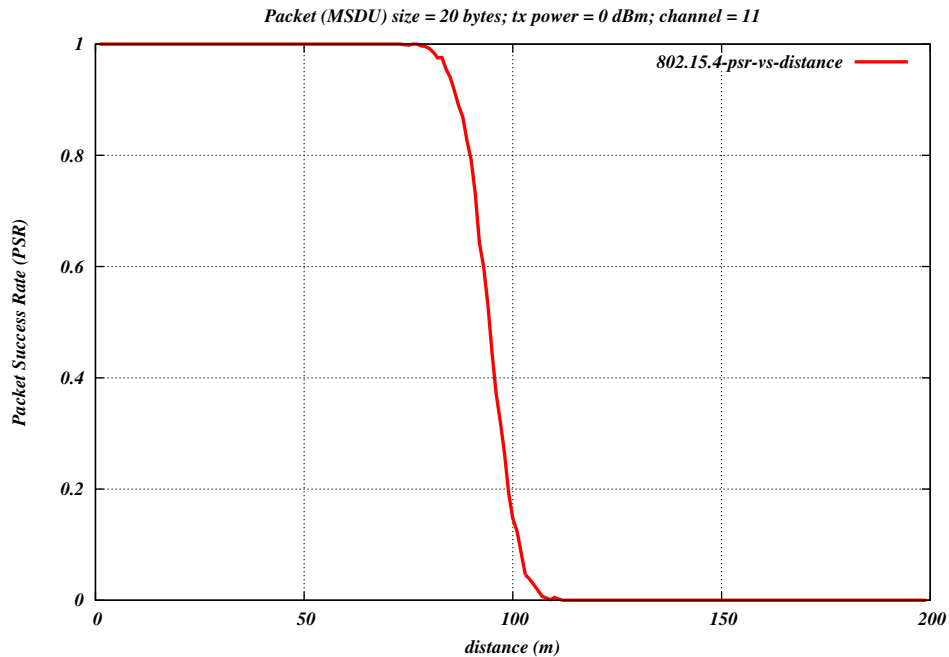

Fig. 5: Default output of the program `lr-wpan-error-distance-plot.cc`

## 18.3 Validation

The model has not been validated against real hardware. The error model has been validated against the data in IEEE Std 802.15.4-2006, section E.4.1.7 (Figure E.2). The MAC behavior (CSMA backoff) has been validated by hand against expected behavior. The below plot is an example of the error model validation and can be reproduced by running `lr-wpan-error-model-plot.cc`:

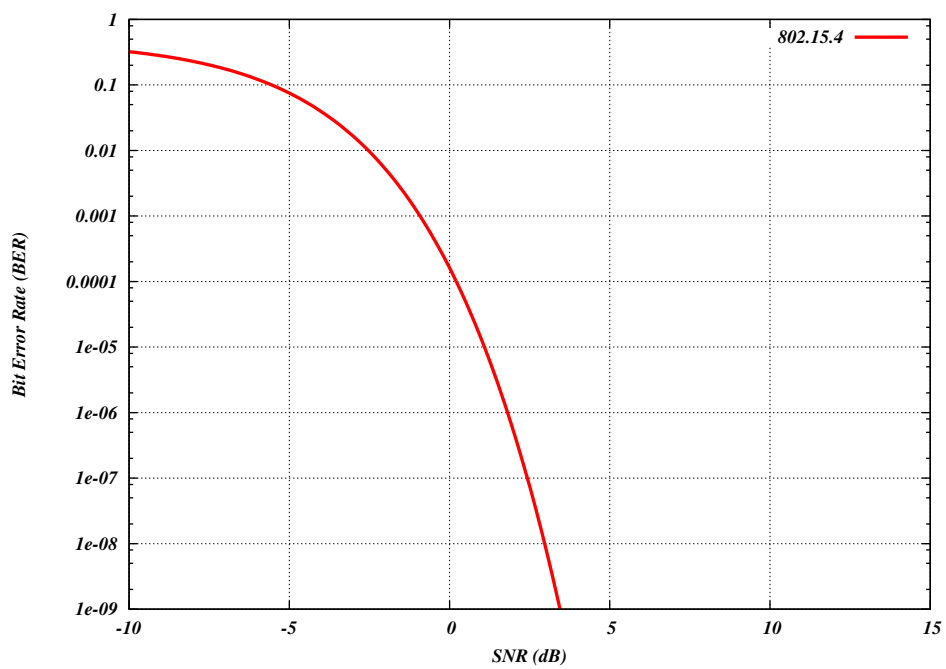

Fig. 6: Default output of the program `lr-wpan-error-model-plot.cc`



## LTE MODULE

### 19.1 Design Documentation

#### 19.1.1 Overview

An overview of the LTE-EPC simulation model is depicted in the figure *Overview of the LTE-EPC simulation model*. There are two main components:

- the LTE Model. This model includes the LTE Radio Protocol stack (RRC, PDCP, RLC, MAC, PHY). These entities reside entirely within the UE and the eNB nodes.
- the EPC Model. This model includes core network interfaces, protocols and entities. These entities and protocols reside within the SGW, PGW and MME nodes, and partially within the eNB nodes.

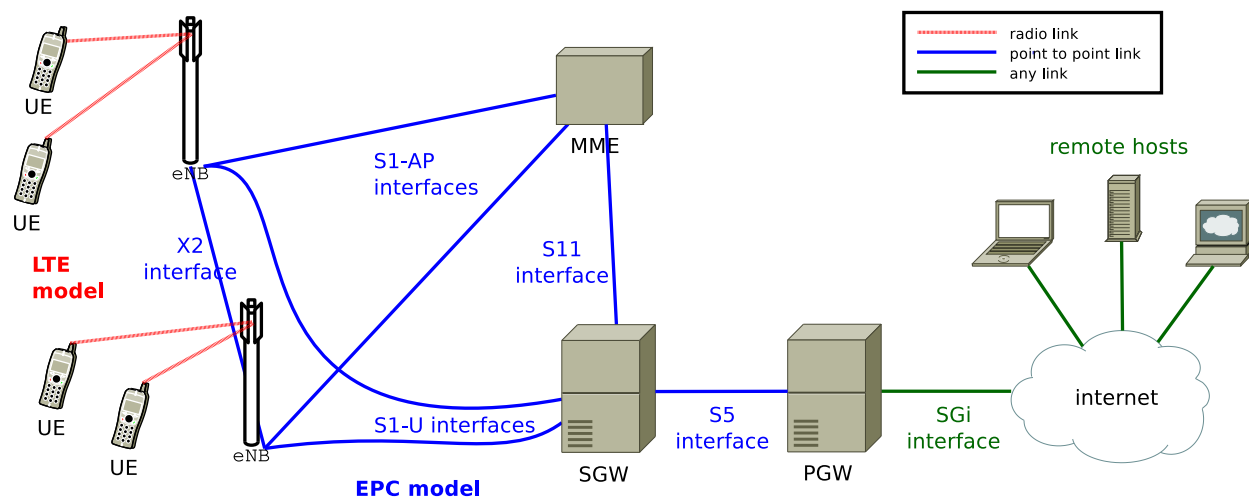

Fig. 1: Overview of the LTE-EPC simulation model

#### 19.1.2 Design Criteria

##### LTE Model

The LTE model has been designed to support the evaluation of the following aspects of LTE systems:

- Radio Resource Management
- QoS-aware Packet Scheduling

- Inter-cell Interference Coordination
- Dynamic Spectrum Access

In order to model LTE systems to a level of detail that is sufficient to allow a correct evaluation of the above mentioned aspects, the following requirements have been considered:

1. At the radio level, the granularity of the model should be at least that of the Resource Block (RB). In fact, this is the fundamental unit being used for resource allocation. Without this minimum level of granularity, it is not possible to model accurately packet scheduling and inter-cell-interference. The reason is that, since packet scheduling is done on a per-RB basis, an eNB might transmit on a subset only of all the available RBs, hence interfering with other eNBs only on those RBs where it is transmitting. Note that this requirement rules out the adoption of a system level simulation approach, which evaluates resource allocation only at the granularity of call/bearer establishment.
2. The simulator should scale up to tens of eNBs and hundreds of User Equipment (UEs). This rules out the use of a link level simulator, i.e., a simulator whose radio interface is modeled with a granularity up to the symbol level. This is because to have a symbol level model it is necessary to implement all the PHY layer signal processing, whose huge computational complexity severely limits simulation. In fact, link-level simulators are normally limited to a single eNB and one or a few UEs.
3. It should be possible within the simulation to configure different cells so that they use different carrier frequencies and system bandwidths. The bandwidth used by different cells should be allowed to overlap, in order to support dynamic spectrum licensing solutions such as those described in [Ofcom2600MHz] and [RealWireless]. The calculation of interference should handle appropriately this case.
4. To be more representative of the LTE standard, as well as to be as close as possible to real-world implementations, the simulator should support the MAC Scheduler API published by the FemtoForum [FFAPI]. This interface is expected to be used by femtocell manufacturers for the implementation of scheduling and Radio Resource Management (RRM) algorithms. By introducing support for this interface in the simulator, we make it possible for LTE equipment vendors and operators to test in a simulative environment exactly the same algorithms that would be deployed in a real system.
5. The LTE simulation model should contain its own implementation of the API defined in [FFAPI]. Neither binary nor data structure compatibility with vendor-specific implementations of the same interface are expected; hence, a compatibility layer should be interposed whenever a vendor-specific MAC scheduler is to be used with the simulator. This requirement is necessary to allow the simulator to be independent from vendor-specific implementations of this interface specification. We note that [FFAPI] is a logical specification only, and its implementation (e.g., translation to some specific programming language) is left to the vendors.
6. The model is to be used to simulate the transmission of IP packets by the upper layers. With this respect, it shall be considered that in LTE the Scheduling and Radio Resource Management do not work with IP packets directly, but rather with RLC PDUs, which are obtained by segmentation and concatenation of IP packets done by the RLC entities. Hence, these functionalities of the RLC layer should be modeled accurately.

### EPC Model

The main objective of the EPC model is to provide means for the simulation of end-to-end IP connectivity over the LTE model. To this aim, it supports for the interconnection of multiple UEs to the Internet, via a radio access network of multiple eNBs connected to the core network, as shown in Figure *Overview of the LTE-EPC simulation model*.

The following design choices have been made for the EPC model:

1. The Packet Data Network (PDN) type supported is both IPv4 and IPv6. In other words, the end-to-end connections between the UEs and the remote hosts can be IPv4 and IPv6. However, the networks between the core network elements (MME, SGWs and PGWs) are IPv4-only.
2. The SGW and PGW functional entities are implemented in different nodes, which are hence referred to as the SGW node and PGW node, respectively.

3. The MME functional entities is implemented as a network node, which is hence referred to as the MME node.
4. The scenarios with inter-SGW mobility are not of interest. But several SGW nodes may be present in simulations scenarios.
5. A requirement for the EPC model is that it can be used to simulate the end-to-end performance of realistic applications. Hence, it should be possible to use with the EPC model any regular ns-3 application working on top of TCP or UDP.
6. Another requirement is the possibility of simulating network topologies with the presence of multiple eNBs, some of which might be equipped with a backhaul connection with limited capabilities. In order to simulate such scenarios, the user data plane protocols being used between the eNBs and the SGW should be modeled accurately.
7. It should be possible for a single UE to use different applications with different QoS profiles. Hence, multiple EPS bearers should be supported for each UE. This includes the necessary classification of TCP/UDP traffic over IP done at the UE in the uplink and at the PGW in the downlink.
8. The initial focus of the EPC model is mainly on the EPC data plane. The accurate modeling of the EPC control plane is, for the time being, not a requirement; however, the necessary control plane interactions among the different network nodes of the core network are realized by implementing control protocols/messages among them. Direct interaction among the different simulation objects via the provided helper objects should be avoided as much as possible.
9. The focus of the EPC model is on simulations of active users in ECM connected mode. Hence, all the functionality that is only relevant for ECM idle mode (in particular, tracking area update and paging) are not modeled at all.
10. The model should allow the possibility to perform an X2-based handover between two eNBs.

### 19.1.3 Architecture

#### LTE Model

##### UE architecture

The architecture of the LTE radio protocol stack model of the UE is represented in the figures *LTE radio protocol stack architecture for the UE on the data plane* and *LTE radio protocol stack architecture for the UE on the control plane* which highlight respectively the data plane and the control plane.

The architecture of the PHY/channel model of the UE is represented in figure *PHY and channel model architecture for the UE*.

##### eNB architecture

The architecture of the LTE radio protocol stack model of the eNB is represented in the figures *LTE radio protocol stack architecture for the eNB on the data plane* and *LTE radio protocol stack architecture for the eNB on the control plane* which highlight respectively the data plane and the control plane.

The architecture of the PHY/channel model of the eNB is represented in figure *PHY and channel model architecture for the eNB*.

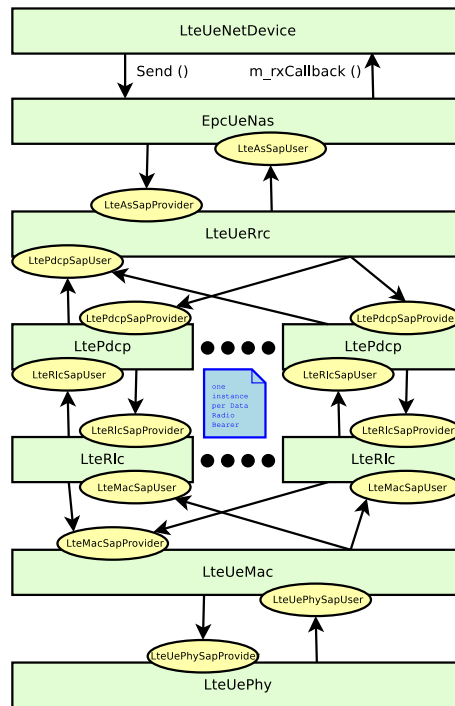

Fig. 2: LTE radio protocol stack architecture for the UE on the data plane

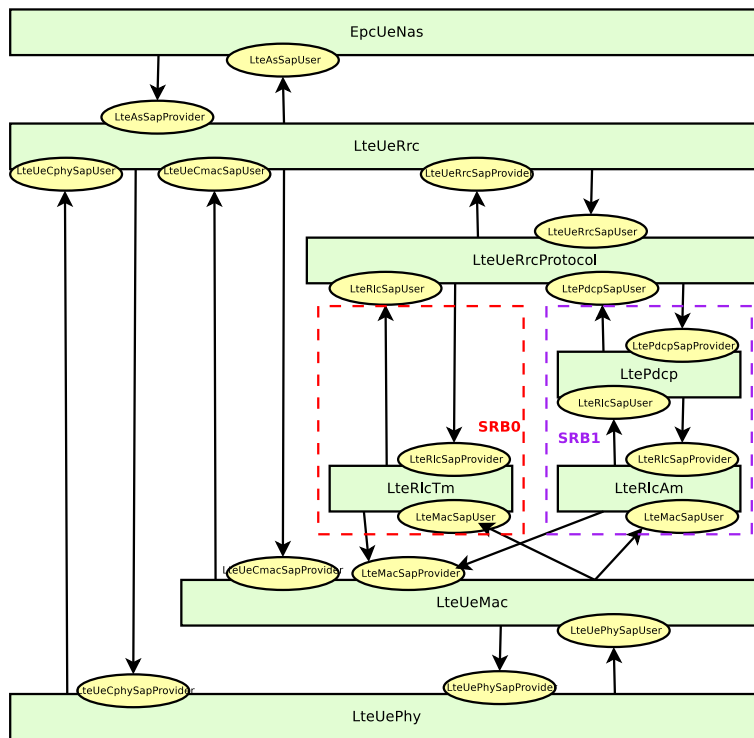

Fig. 3: LTE radio protocol stack architecture for the UE on the control plane

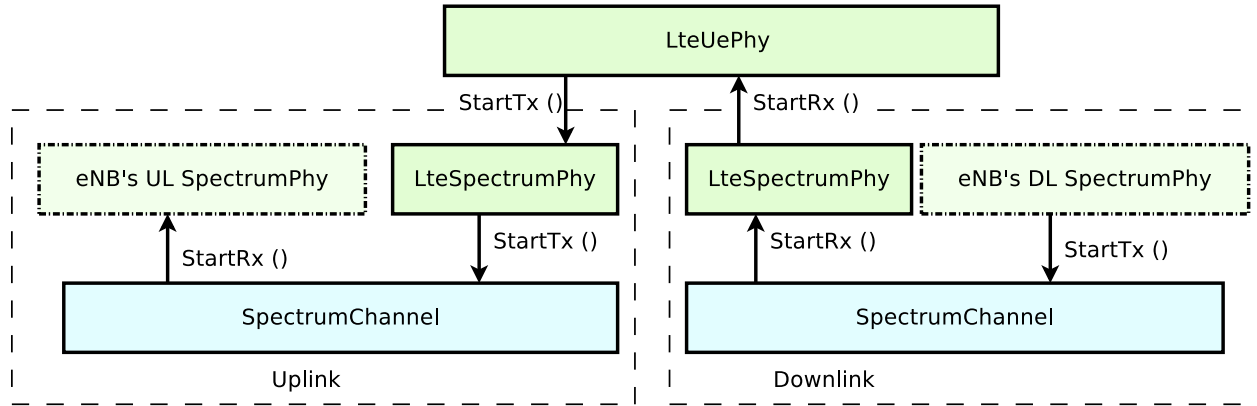

Fig. 4: PHY and channel model architecture for the UE

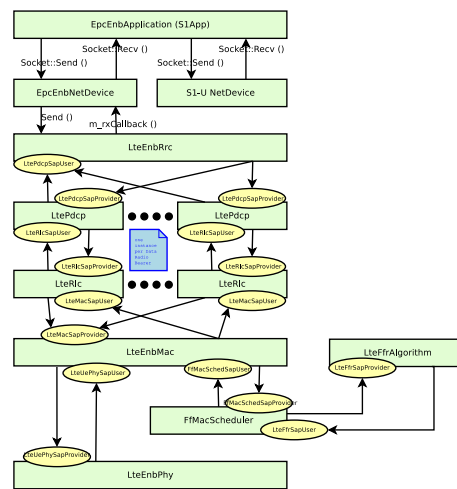

Fig. 5: LTE radio protocol stack architecture for the eNB on the data plane

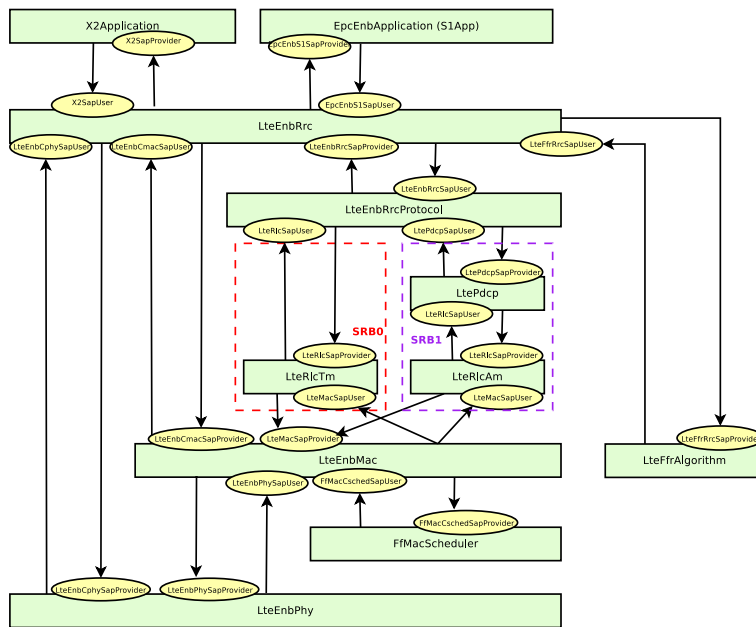

Fig. 6: LTE radio protocol stack architecture for the eNB on the control plane

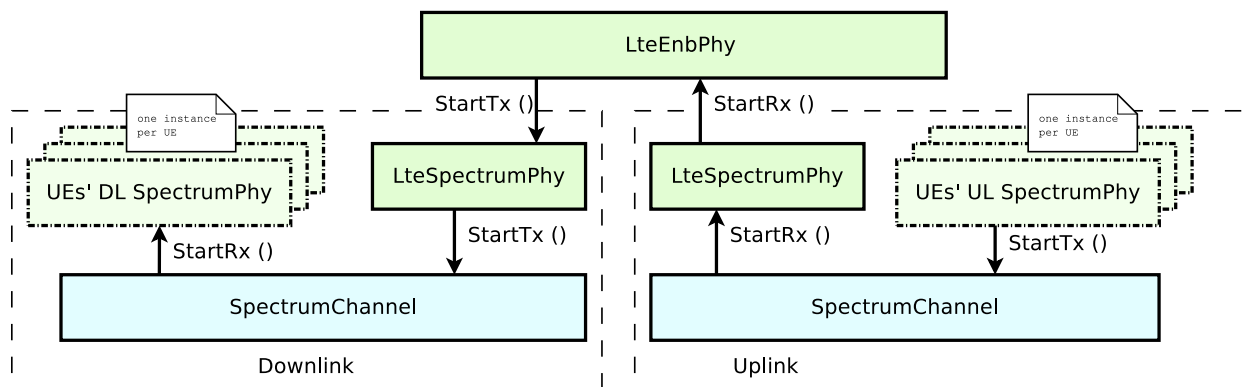

Fig. 7: PHY and channel model architecture for the eNB

## EPC Model

### EPC data plane

In Figure *LTE-EPC data plane protocol stack*, we represent the end-to-end LTE-EPC data plane protocol stack as it is modeled in the simulator. The figure shows all nodes in the data path, i.e. UE, eNB, SGW, PGW and a remote host in the Internet. All protocol stacks (S5 protocol stack, S1-U protocol stack and the LTE radio protocol stack) specified by 3GPP are present.

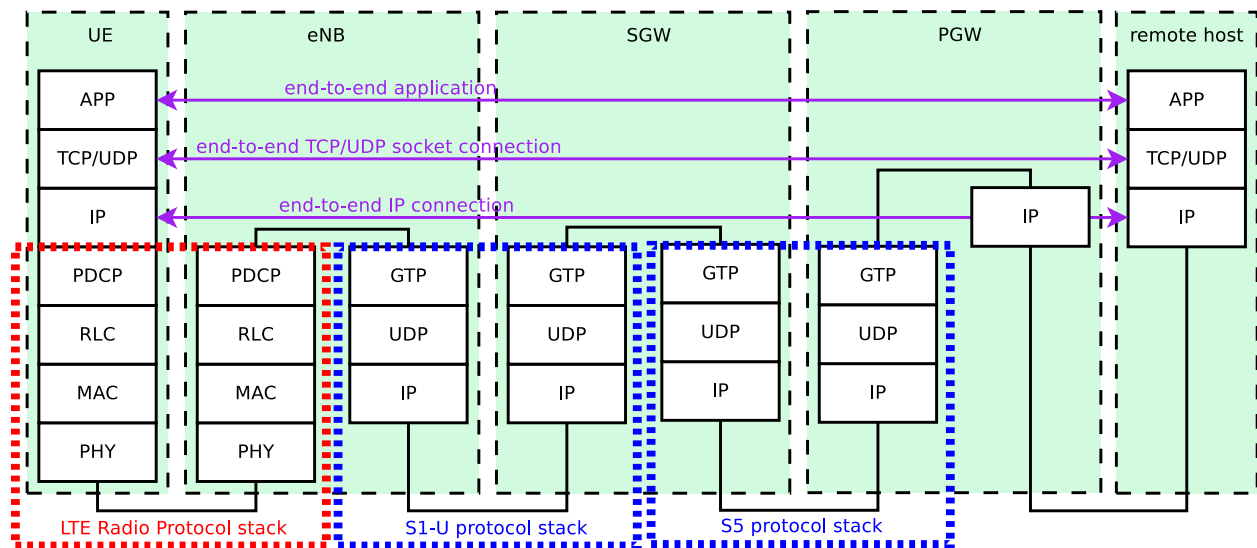

Fig. 8: LTE-EPC data plane protocol stack

### EPC control plane

The architecture of the implementation of the control plane model is shown in figure *LTE-EPC control plane protocol stack*. The control interfaces that are modeled explicitly are the S1-MME, the S11, and the S5 interfaces. The X2 interface is also modeled explicitly and it is described in more detail in section *X2*

The S1-MME, the S11 and the S5 interfaces are modeled using protocol data units sent over its respective links. These interfaces use the SCTP protocol as transport protocol but currently, the SCTP protocol is not modeled in the ns-3 simulator, so the UDP protocol is used instead of the SCTP protocol.

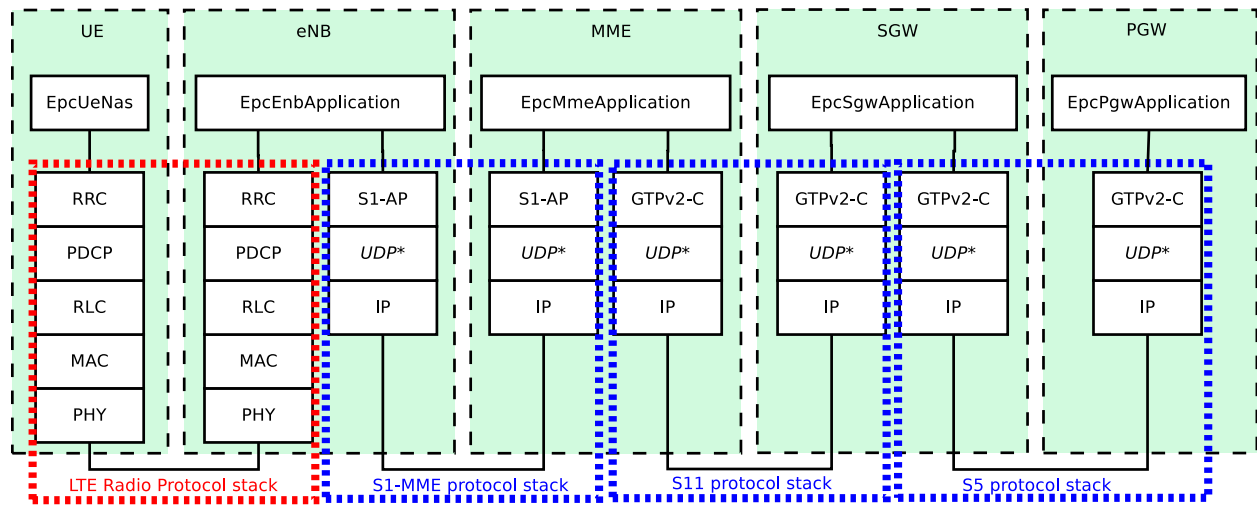

Fig. 9: LTE-EPC control plane protocol stack



## 19.1.4 Channel and Propagation

For channel modeling purposes, the LTE module uses the `SpectrumChannel` interface provided by the spectrum module. At the time of this writing, two implementations of such interface are available: `SingleModelSpectrumChannel` and `MultiModelSpectrumChannel`, and the LTE module requires the use of the `MultiModelSpectrumChannel` in order to work properly. This is because of the need to support different frequency and bandwidth configurations. All the propagation models supported by `MultiModelSpectrumChannel` can be used within the LTE module.

### Use of the Buildings model with LTE

The recommended propagation model to be used with the LTE module is the one provided by the Buildings module, which was in fact designed specifically with LTE (though it can be used with other wireless technologies as well). Please refer to the documentation of the Buildings module for generic information on the propagation model it provides.

In this section we will highlight some considerations that specifically apply when the Buildings module is used together with the LTE module.

The naming convention used in the following will be:

- User equipment: UE
- Macro Base Station: MBS
- Small cell Base Station (e.g., pico/femtocell): SC

The LTE module considers FDD only, and implements downlink and uplink propagation separately. As a consequence, the following pathloss computations are performed

- MBS <-> UE (indoor and outdoor)
- SC (indoor and outdoor) <-> UE (indoor and outdoor)

The LTE model does not provide the following pathloss computations:

- UE <-> UE
- MBS <-> MBS
- MBS <-> SC
- SC <-> SC

The Buildings model does not know the actual type of the node; i.e., it is not aware of whether a transmitter node is a UE, a MBS, or a SC. Rather, the Buildings model only cares about the position of the node: whether it is indoor and outdoor, and what is its z-axis respect to the rooftop level. As a consequence, for an eNB node that is placed outdoor and at a z-coordinate above the rooftop level, the propagation models typical of MBS will be used by the Buildings module. Conversely, for an eNB that is placed outdoor but below the rooftop, or indoor, the propagation models typical of pico and femtocells will be used.

For communications involving at least one indoor node, the corresponding wall penetration losses will be calculated by the Buildings model. This covers the following use cases:

- MBS <-> indoor UE
- outdoor SC <-> indoor UE
- indoor SC <-> indoor UE
- indoor SC <-> outdoor UE

Please refer to the documentation of the Buildings module for details on the actual models used in each case.

## Fading Model

The LTE module includes a trace-based fading model derived from the one developed during the GSoC 2010 [Piro2011]. The main characteristic of this model is the fact that the fading evaluation during simulation run-time is based on pre-calculated traces. This is done to limit the computational complexity of the simulator. On the other hand, it needs huge structures for storing the traces; therefore, a trade-off between the number of possible parameters and the memory occupancy has to be found. The most important ones are:

- users' speed: relative speed between users (affects the Doppler frequency, which in turns affects the time-variance property of the fading)
- number of taps (and relative power): number of multiple paths considered, which affects the frequency property of the fading.
- time granularity of the trace: sampling time of the trace.
- frequency granularity of the trace: number of values in frequency to be evaluated.
- length of trace: ideally large as the simulation time, might be reduced by windowing mechanism.
- number of users: number of independent traces to be used (ideally one trace per user).

With respect to the mathematical channel propagation model, we suggest the one provided by the `rayleighchan` function of Matlab, since it provides a well accepted channel modelization both in time and frequency domain. For more information, the reader is referred to [mathworks].

The simulator provides a matlab script (`src/lte/model/fading-traces/fading-trace-generator.m`) for generating traces based on the format used by the simulator. In detail, the channel object created with the `rayleighchan` function is used for filtering a discrete-time impulse signal in order to obtain the channel impulse response. The filtering is repeated for different TTI, thus yielding subsequent time-correlated channel responses (one per TTI). The channel response is then processed with the `pwelch` function for obtaining its power spectral density values, which are then saved in a file with the proper format compatible with the simulator model.

Since the number of variable it is pretty high, generate traces considering all of them might produce a high number of traces of huge size. On this matter, we considered the following assumptions of the parameters based on the 3GPP fading propagation conditions (see Annex B.2 of [TS36104]):

- users' speed: typically only a few discrete values are considered, i.e.:
  - 0 and 3 kmph for pedestrian scenarios
  - 30 and 60 kmph for vehicular scenarios
  - 0, 3, 30 and 60 for urban scenarios
- channel taps: only a limited number of sets of channel taps are normally considered, for example three models are mentioned in Annex B.2 of [TS36104].
- time granularity: we need one fading value per TTI, i.e., every 1 ms (as this is the granularity in time of the ns-3 LTE PHY model).
- frequency granularity: we need one fading value per RB (which is the frequency granularity of the spectrum model used by the ns-3 LTE model).
- length of the trace: the simulator includes the windowing mechanism implemented during the GSoC 2011, which consists of picking up a window of the trace each window length in a random fashion.
- per-user fading process: users share the same fading trace, but for each user a different starting point in the trace is randomly picked up. This choice was made to avoid the need to provide one fading trace per user.

According to the parameters we considered, the following formula express in detail the total size  $S_{traces}$  of the fading traces:

$$S_{traces} = S_{sample} \times N_{RB} \times \frac{T_{trace}}{T_{sample}} \times N_{scenarios} \text{ [bytes]}$$

where  $S_{sample}$  is the size in bytes of the sample (e.g., 8 in case of double precision, 4 in case of float precision),  $N_{RB}$  is the number of RB or set of RBs to be considered,  $T_{trace}$  is the total length of the trace,  $T_{sample}$  is the time resolution of the trace (1 ms), and  $N_{scenarios}$  is the number of fading scenarios that are desired (i.e., combinations of different sets of channel taps and user speed values). We provide traces for 3 different scenarios one for each taps configuration defined in Annex B.2 of [TS36104]:

- Pedestrian: with nodes' speed of 3 kmph.
- Vehicular: with nodes' speed of 60 kmph.
- Urban: with nodes' speed of 3 kmph.

hence  $N_{scenarios} = 3$ . All traces have  $T_{trace} = 10$  s and  $RB_{NUM} = 100$ . This results in a total 24 MB bytes of traces.

## Antennas

Being based on the `SpectrumPhy`, the LTE PHY model supports antenna modeling via the ns-3 `AntennaModel` class. Hence, any model based on this class can be associated with any eNB or UE instance. For instance, the use of the `CosineAntennaModel` associated with an eNB device allows to model one sector of a macro base station. By default, the `IsotropicAntennaModel` is used for both eNBs and UEs.

## 19.1.5 PHY

### Overview

The physical layer model provided in this LTE simulator is based on the one described in [Piro2011], with the following modifications. The model now includes the inter cell interference calculation and the simulation of uplink traffic, including both packet transmission and CQI generation.

### Subframe Structure

The subframe is divided into control and data part as described in Figure *LTE subframe division..*

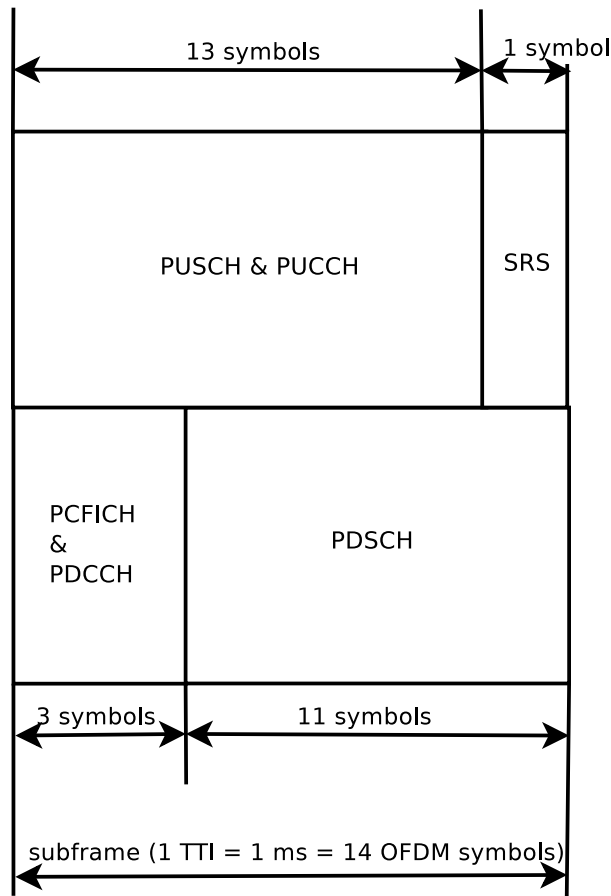

Fig. 10: LTE subframe division.

Considering the granularity of the simulator based on RB, the control and the reference signaling have to be consequently modeled considering this constraint. According to the standard [TS36211], the downlink control frame starts at the beginning of each subframe and lasts up to three symbols across the whole system bandwidth, where the actual duration is provided by the Physical Control Format Indicator Channel (PCFICH). The information on the allocation are then mapped in the remaining resource up to the duration defined by the PCFICH, in the so called Physical Downlink Control Channel (PDCCH). A PDCCH transports a single message called Downlink Control Information (DCI) coming from the MAC layer, where the scheduler indicates the resource allocation for a specific user. The PCFICH and PDCCH are modeled with the transmission of the control frame of a fixed duration of 3/14 of milliseconds spanning in the whole available bandwidth, since the scheduler does not estimate the size of the control region. This implies that a single transmission block models the entire control frame with a fixed power (i.e., the one used for the

PDSCH) across all the available RBs. According to this feature, this transmission represents also a valuable support for the Reference Signal (RS). This allows of having every TTI an evaluation of the interference scenario since all the eNB are transmitting (simultaneously) the control frame over the respective available bandwidths. We note that, the model does not include the power boosting since it does not reflect any improvement in the implemented model of the channel estimation.

The Sounding Reference Signal (SRS) is modeled similar to the downlink control frame. The SRS is periodically placed in the last symbol of the subframe in the whole system bandwidth. The RRC module already includes an algorithm for dynamically assigning the periodicity as function of the actual number of UEs attached to a eNB according to the UE-specific procedure (see Section 8.2 of [TS36213]).

## MAC to Channel delay

To model the latency of real MAC and PHY implementations, the PHY model simulates a MAC-to-channel delay in multiples of TTIs (1ms). The transmission of both data and control packets are delayed by this amount.

## CQI feedback

The generation of CQI feedback is done accordingly to what specified in [FFAPI]. In detail, we considered the generation of periodic wideband CQI (i.e., a single value of channel state that is deemed representative of all RBs in use) and inband CQIs (i.e., a set of value representing the channel state for each RB).

The CQI index to be reported is obtained by first obtaining a SINR measurement and then passing this SINR measurement to the *Adaptive Modulation and Coding* module which will map it to the CQI index.

In downlink, the SINR used to generate CQI feedback can be calculated in two different ways:

1. *Ctrl* method: SINR is calculated combining the signal power from the reference signals (which in the simulation is equivalent to the PDCCH) and the interference power from the PDCCH. This approach results in considering any neighboring eNB as an interferer, regardless of whether this eNB is actually performing any PDSCH transmission, and regardless of the power and RBs used for eventual interfering PDSCH transmissions.
2. *Mixed* method: SINR is calculated combining the signal power from the reference signals (which in the simulation is equivalent to the PDCCH) and the interference power from the PDSCH. This approach results in considering as interferers only those neighboring eNBs that are actively transmitting data on the PDSCH, and allows to generate inband CQIs that account for different amounts of interference on different RBs according to the actual interference level. In the case that no PDSCH transmission is performed by any eNB, this method consider that interference is zero, i.e., the SINR will be calculated as the ratio of signal to noise only.

To switch between this two CQI generation approaches, `LteHelper::UsePdschForCqiGeneration` needs to be configured: false for first approach and true for second approach (true is default value):

```
Config::SetDefault ("ns3::LteHelper::UsePdschForCqiGeneration", BooleanValue (true));
```

In uplink, two types of CQIs are implemented:

- SRS based, periodically sent by the UEs.
- PUSCH based, calculated from the actual transmitted data.

The scheduler interface include an attribute system called `ULCqiFilter` for managing the filtering of the CQIs according to their nature, in detail:

- `SRS_UL_CQI` for storing only SRS based CQIs.
- `PUSCH_UL_CQI` for storing only PUSCH based CQIs.

It has to be noted that, the `FfMacScheduler` provides only the interface and it is matter of the actual scheduler implementation to include the code for managing these attributes (see scheduler related section for more information on this matter).

## Interference Model

The PHY model is based on the well-known Gaussian interference models, according to which the powers of interfering signals (in linear units) are summed up together to determine the overall interference power.

The sequence diagram of Figure *Sequence diagram of the PHY interference calculation procedure* shows how interfering signals are processed to calculate the SINR, and how SINR is then used for the generation of CQI feedback.

## LTE Spectrum Model

The usage of the radio spectrum by eNBs and UEs in LTE is described in [TS36101]. In the simulator, radio spectrum usage is modeled as follows. Let  $f_c$  denote the LTE Absolute Radio Frequency Channel Number, which identifies the carrier frequency on a 100 kHz raster; furthermore, let  $B$  be the Transmission Bandwidth Configuration in number of Resource Blocks. For every pair  $(f_c, B)$  used in the simulation we define a corresponding `SpectrumModel` using the functionality provided by the *Spectrum Module*. model using the Spectrum framework described in [Baldo2009].  $f_c$  and  $B$  can be configured for every eNB instantiated in the simulation; hence, each eNB can use a different spectrum model. Every UE will automatically use the spectrum model of the eNB it is attached to. Using the `MultiModelSpectrumChannel` described in [Baldo2009], the interference among eNBs that use different spectrum models is properly accounted for. This allows to simulate dynamic spectrum access policies, such as for example the spectrum licensing policies that are discussed in [Ofcom2600MHz].

## Data PHY Error Model

The simulator includes an error model of the data plane (i.e., PDSCH and PUSCH) according to the standard link-to-system mapping (LSM) techniques. The choice is aligned with the standard system simulation methodology of OFDMA radio transmission technology. Thanks to LSM we are able to maintain a good level of accuracy and at the same time limiting the computational complexity increase. It is based on the mapping of single link layer performance obtained by means of link level simulators to system (in our case network) simulators. In particular link the layer simulator is used for generating the performance of a single link from a PHY layer perspective, usually in terms of code block error rate (BLER), under specific static conditions. LSM allows the usage of these parameters in more complex scenarios, typical of system/network simulators, where we have more links, interference and “colored” channel propagation phenomena (e.g., frequency selective fading).

To do this the Vienna LTE Simulator [ViennaLteSim] has been used for what concerns the extraction of link layer performance and the Mutual Information Based Effective SINR (MIESM) as LSM mapping function using part of the work recently published by the Signet Group of University of Padua [PaduaPEM].

## MIESM

The specific LSM method adopted is the one based on the usage of a mutual information metric, commonly referred to as the mutual information per per coded bit (MIB or MMIB when a mean of multiples MIBs is involved). Another option would be represented by the Exponential ESM (EESM); however, recent studies demonstrate that MIESM outperforms EESM in terms of accuracy [LozanoCost].

The mutual information (MI) is dependent on the constellation mapping and can be calculated per transport block (TB) basis, by evaluating the MI over the symbols and the subcarrier. However, this would be too complex for a network simulator. Hence, in our implementation a flat channel response within the RB has been considered; therefore the overall MI of a TB is calculated averaging the MI evaluated per each RB used in the TB. In detail, the implemented

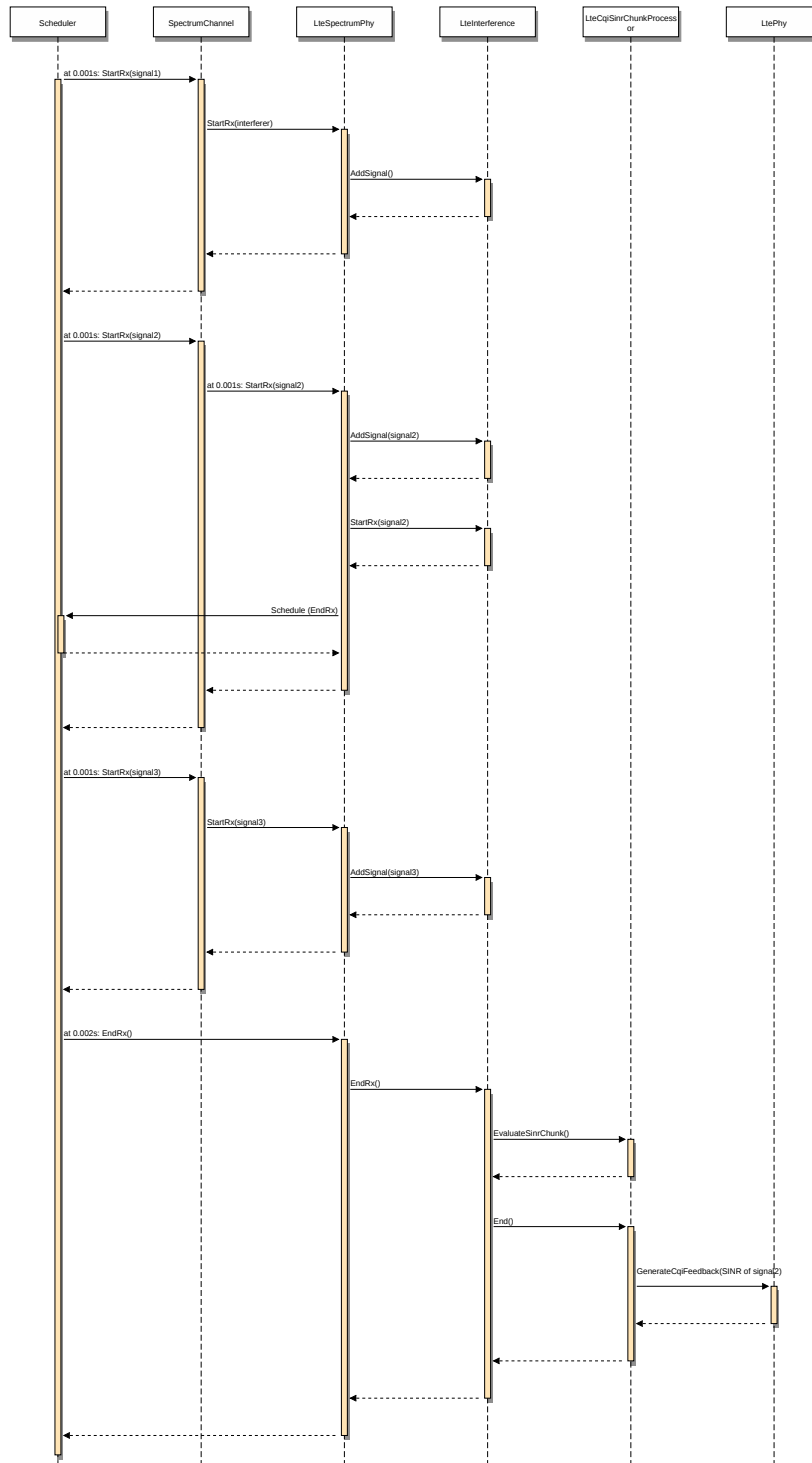

Fig. 11: Sequence diagram of the PHY interference calculation procedure

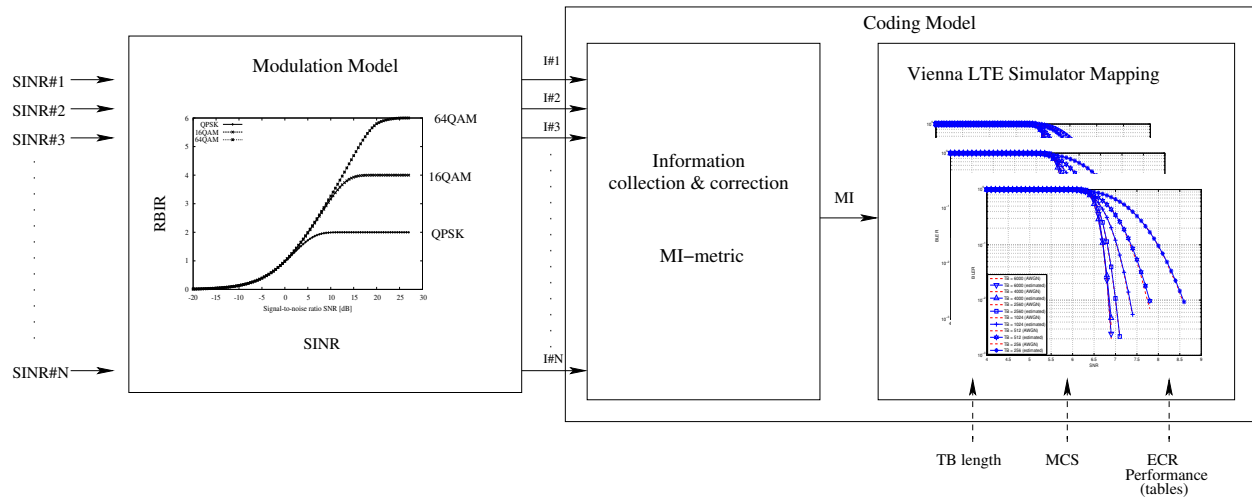

Fig. 12: MIESM computational procedure diagram

scheme is depicted in Figure *MIESM computational procedure diagram*, where we see that the model starts by evaluating the MI value for each RB, represented in the figure by the SINR samples. Then the equivalent MI is evaluated per TB basis by averaging the MI values. Finally, a further step has to be done since the link level simulator returns the performance of the link in terms of block error rate (BLER) in a additive white gaussian noise (AWGN) channel, where the blocks are the code blocks (CBs) independently encoded/decoded by the turbo encoder. On this matter the standard 3GPP segmentation scheme has been used for estimating the actual CB size (described in section 5.1.2 of [TS36212]). This scheme divides the TB in  $N_{K_-}$  blocks of size  $K_-$  and  $N_{K_+}$  blocks of size  $K_+$ . Therefore the overall TB BLER (TBLER) can be expressed as

$$TBLER = 1 - \prod_{i=1}^C (1 - CBLER_i)$$

where the  $CBLER_i$  is the BLER of the CB  $i$  obtained according to the link level simulator CB BLER curves. For estimating the  $CBLER_i$ , the MI evaluation has been implemented according to its numerical approximation defined in [wimaxEmd]. Moreover, for reducing the complexity of the computation, the approximation has been converted into lookup tables. In detail, Gaussian cumulative model has been used for approximating the AWGN BLER curves with three parameters which provides a close fit to the standard AWGN performances, in formula:

$$CBLER_i = \frac{1}{2} \left[ 1 - \operatorname{erf} \left( \frac{x - b_{ECR}}{\sqrt{2}c_{ECR}} \right) \right]$$

where  $x$  is the MI of the TB,  $b_{ECR}$  represents the “transition center” and  $c_{ECR}$  is related to the “transition width” of the Gaussian cumulative distribution for each Effective Code Rate (ECR) which is the actual transmission rate according to the channel coding and MCS. For limiting the computational complexity of the model we considered only a subset of the possible ECRs in fact we would have potentially 5076 possible ECRs (i.e., 27 MCSs and 188 CB sizes). On this respect, we will limit the CB sizes to some representative values (i.e., 40, 140, 160, 256, 512, 1024, 2048, 4032, 6144), while for the others the worst one approximating the real one will be used (i.e., the smaller CB size value available respect to the real one). This choice is aligned to the typical performance of turbo codes, where the CB size is not strongly impacting on the BLER. However, it is to be notes that for CB sizes lower than 1000 bits the effect might be relevant (i.e., till 2 dB); therefore, we adopt this unbalanced sampling interval for having more precision where it is necessary. This behaviour is confirmed by the figures presented in the Annex Section.

## BLER Curves

On this respect, we reused part of the curves obtained within [PaduaPEM]. In detail, we introduced the CB size dependency to the CB BLER curves with the support of the developers of [PaduaPEM] and of the LTE Vienna Simulator.



In fact, the module released provides the link layer performance only for what concerns the MCSs (i.e. with a given fixed ECR). In detail the new error rate curves for each has been evaluated with a simulation campaign with the link layer simulator for a single link with AWGN noise and for CB size of 104, 140, 256, 512, 1024, 2048, 4032 and 6144. These curves has been mapped with the Gaussian cumulative model formula presented above for obtaining the correspondents  $b_{ECR}$  and  $c_{ECR}$  parameters.

The BLER performance of all MCS obtained with the link level simulator are plotted in the following figures (blue lines) together with their correspondent mapping to the Gaussian cumulative distribution (red dashed lines).

## Integration of the BLER curves in the ns-3 LTE module

The model implemented uses the curves for the LSM of the recently LTE PHY Error Model released in the ns3 community by the Signet Group [PaduaPEM] and the new ones generated for different CB sizes. The `LteSpectrumPhy` class is in charge of evaluating the TB BLER thanks to the methods provided by the `LteMiErrorModel` class, which is in charge of evaluating the TB BLER according to the vector of the perceived SINR per RB, the MCS and the size in order to proper model the segmentation of the TB in CBs. In order to obtain the vector of the perceived SINR two instances of `LtePemSinrChunkProcessor` (child of `LteChunkProcessor` dedicated to evaluate the SINR for obtaining physical error performance) have been attached to UE downlink and eNB uplink `LteSpectrumPhy` modules for evaluating the error model distribution respectively of PDSCH (UE side) and ULSCH (eNB side).

The model can be disabled for working with a zero-losses channel by setting the `PemEnabled` attribute of the `LteSpectrumPhy` class (by default is active). This can be done according to the standard ns3 attribute system procedure, that is:

```
Config::SetDefault ("ns3::LteSpectrumPhy::DataErrorModelEnabled", BooleanValue_
↪ (false));
```

## Control Channels PHY Error Model

The simulator includes the error model for downlink control channels (PCFICH and PDCCH), while in uplink it is assumed and ideal error-free channel. The model is based on the MIESM approach presented before for considering the effects of the frequency selective channel since most of the control channels span the whole available bandwidth.

### PCFICH + PDCCH Error Model

The model adopted for the error distribution of these channels is based on an evaluation study carried out in the RAN4 of 3GPP, where different vendors investigated the demodulation performance of the PCFICH jointly with PDCCH. This is due to the fact that the PCFICH is the channel in charge of communicating to the UEs the actual dimension of the PDCCH (which spans between 1 and 3 symbols); therefore the correct decodification of the DCIs depends on the correct interpretation of both ones. In 3GPP this problem have been evaluated for improving the cell-edge performance [FujitsuWhitePaper], where the interference among neighboring cells can be relatively high due to signal degradation. A similar problem has been notices in femto-cell scenario and, more in general, in HetNet scenarios the bottleneck has been detected mainly as the PCFICH channel [Bharucha2011], where in case of many eNBs are deployed in the same service area, this channel may collide in frequency, making impossible the correct detection of the PDCCH channel, too.

In the simulator, the SINR perceived during the reception has been estimated according to the MIESM model presented above in order to evaluate the error distribution of PCFICH and PDCCH. In detail, the SINR samples of all the RBs are included in the evaluation of the MI associated to the control frame and, according to this values, the effective SINR (eSINR) is obtained by inverting the MI evaluation process. It has to be noted that, in case of MIMO transmission, both PCFICH and the PDCCH use always the transmit diversity mode as defined by the standard. According to the eSINR perceived the decodification error probability can be estimated as function of the results presented in [R4-081920].

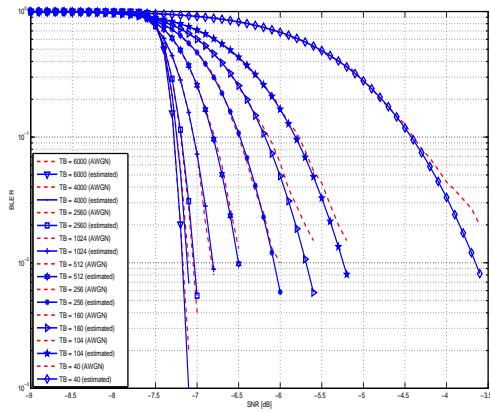

a) MCS1

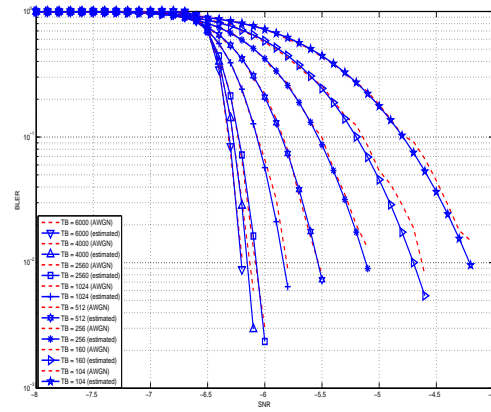

b) MCS2

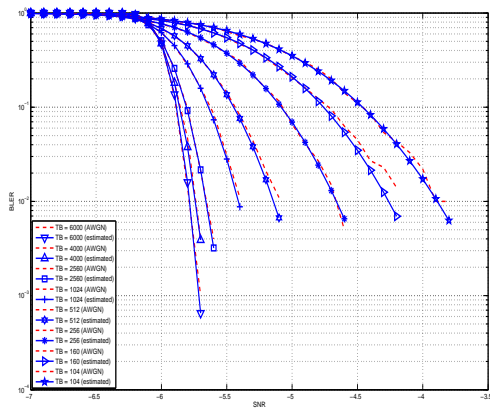

c) MCS3

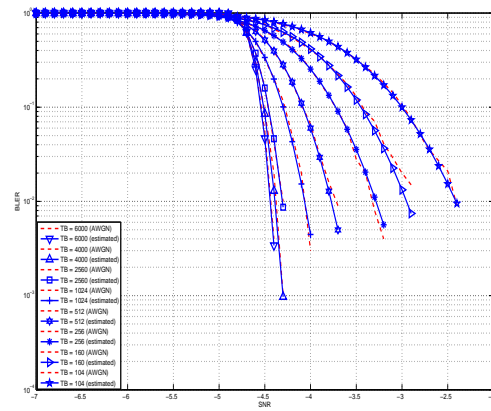

d) MCS4

Fig. 13: BLER for MCS 1, 2, 3 and 4.

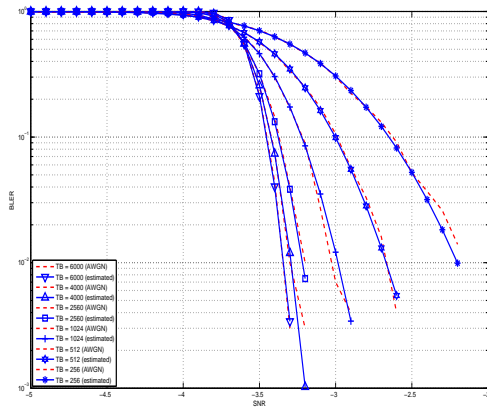

a) MCS5

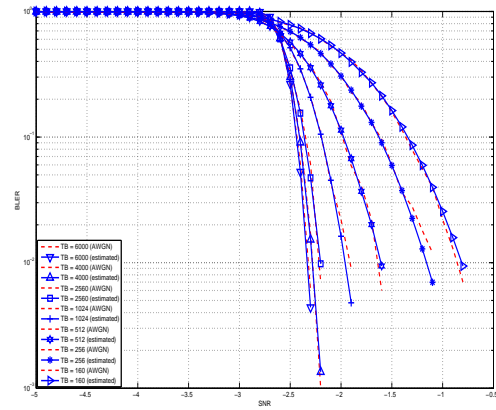

b) MCS6

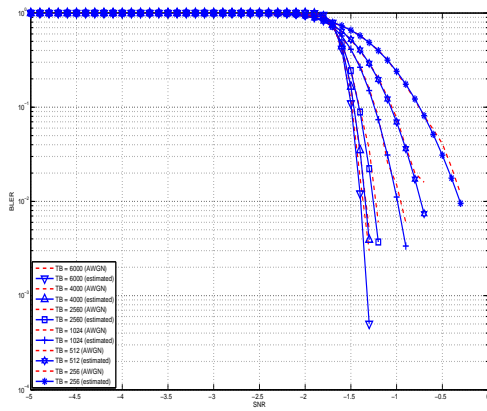

c) MCS7

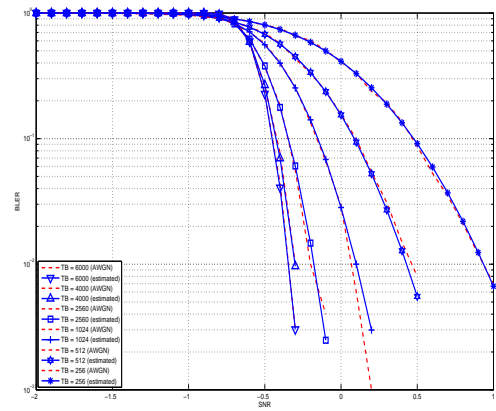

d) MCS8

Fig. 14: BLER for MCS 5, 6, 7 and 8.

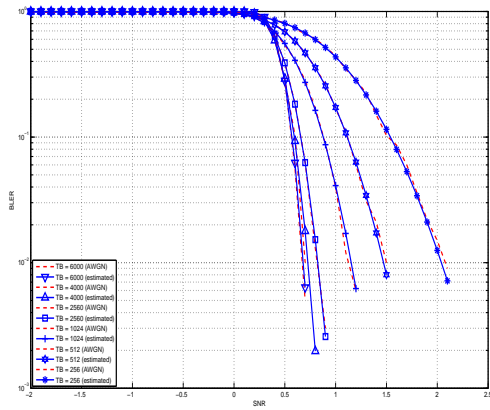

a) MCS9

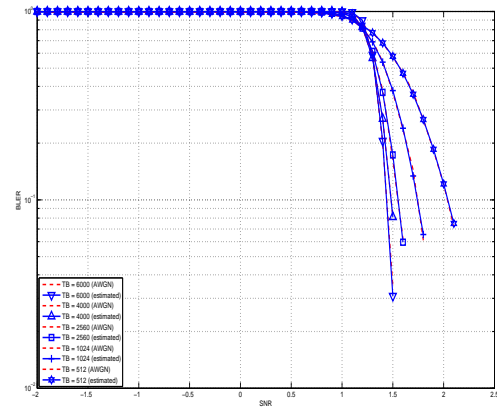

b) MCS10

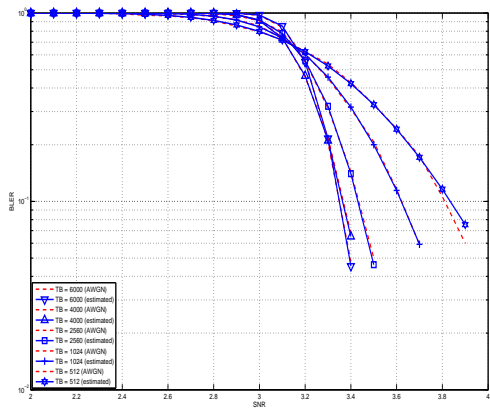

c) MCS11

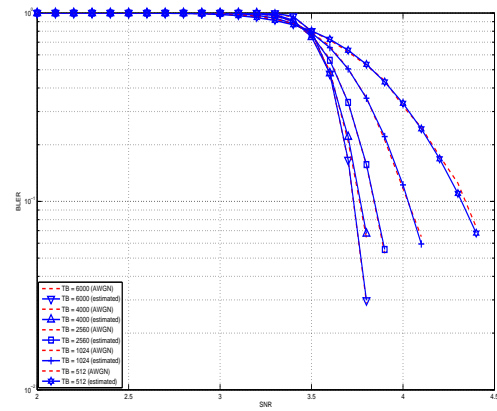

d) MCS12

Fig. 15: BLER for MCS 9, 10, 11 and 12.

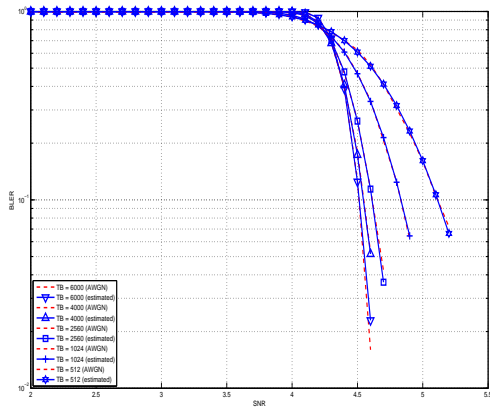

a) MCS13

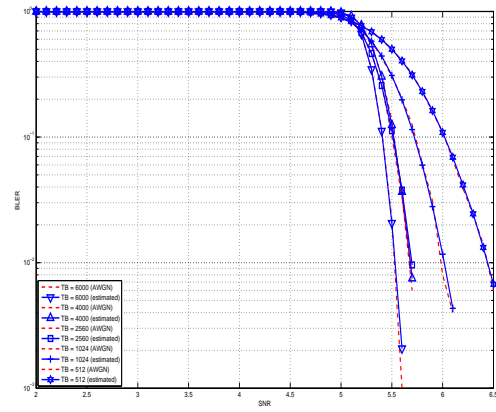

b) MCS14

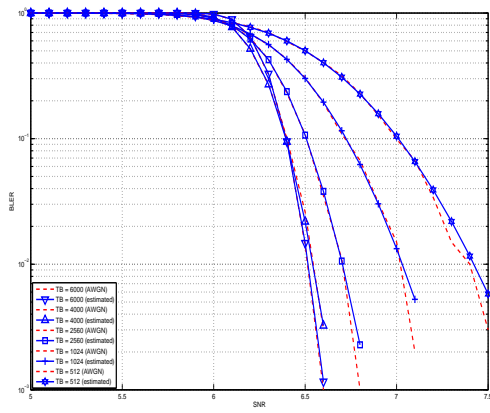

c) MCS15

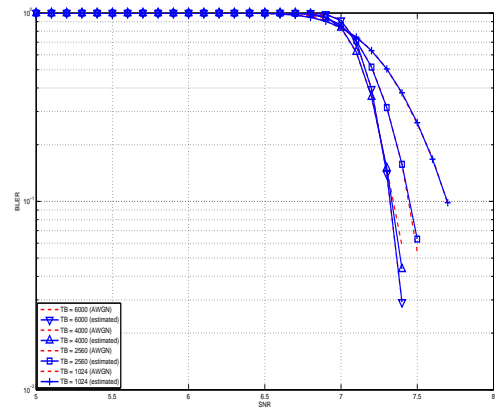

d) MCS16

Fig. 16: BLER for MCS 13, 14, 15 and 16.

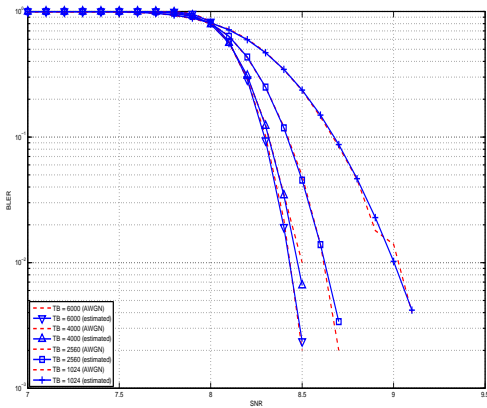

a) MCS17

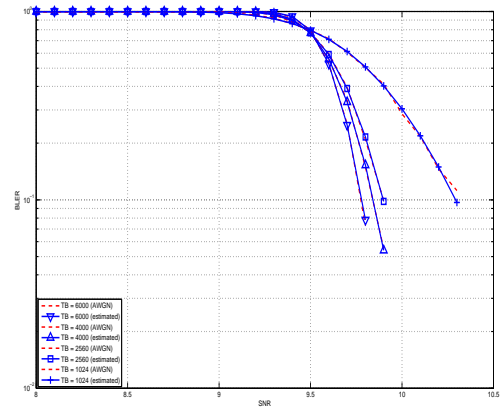

b) MCS18

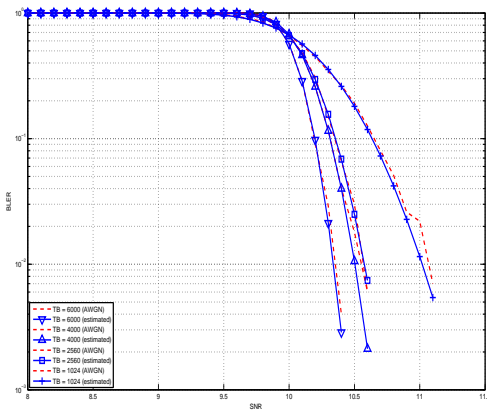

c) MCS19

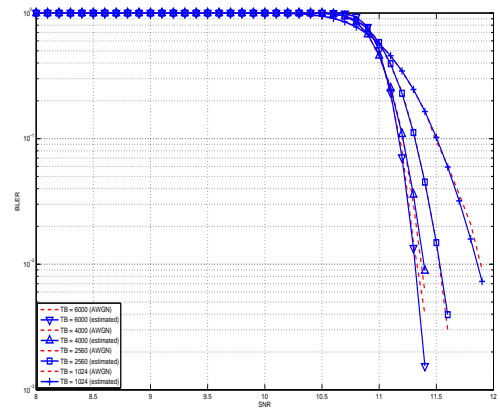

d) MCS20

Fig. 17: BLER for MCS 17, 17, 19 and 20.

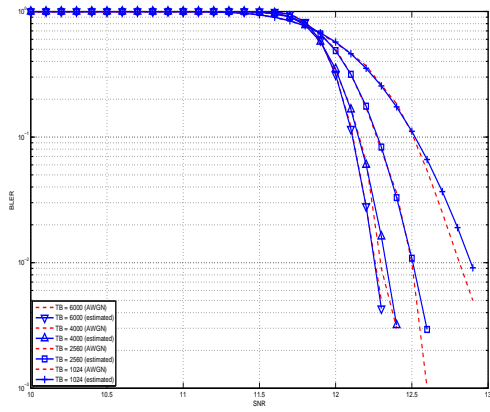

a) MCS21

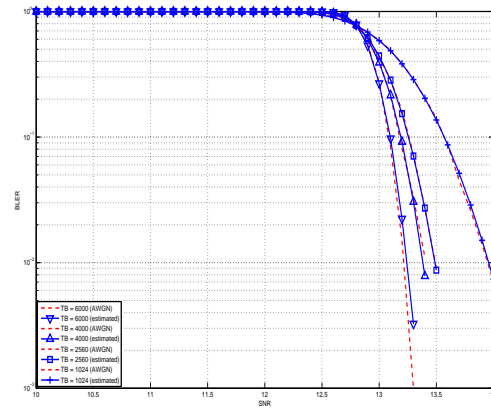

b) MCS22

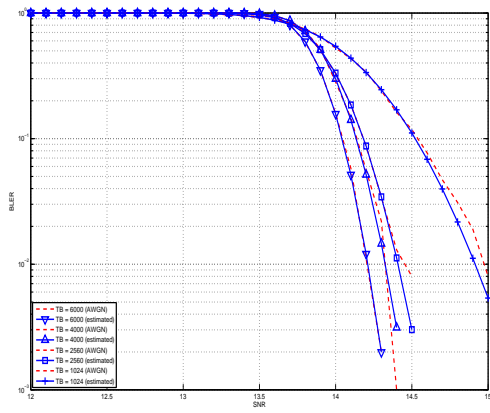

c) MCS23

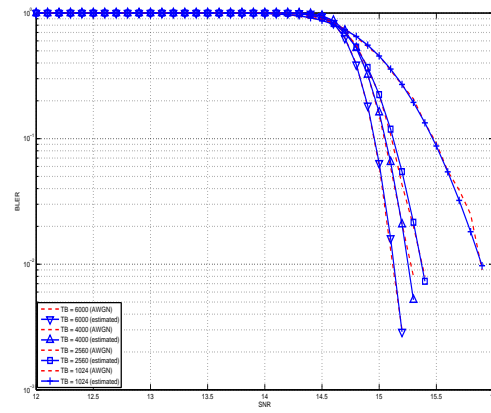

d) MCS24

Fig. 18: BLER for MCS 21, 22, 23 and 24.

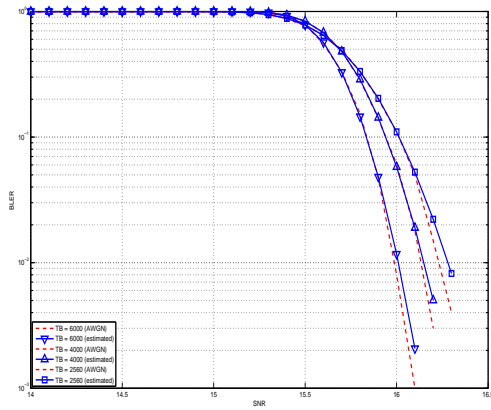

a) MCS25

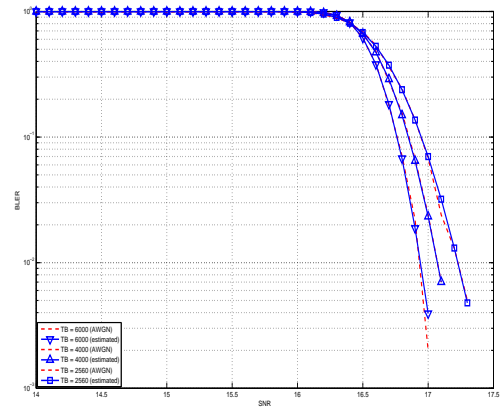

b) MCS26

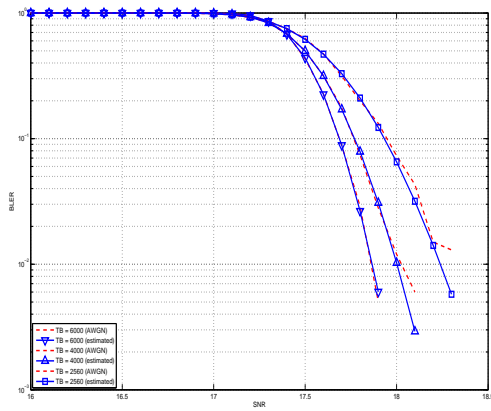

c) MCS27

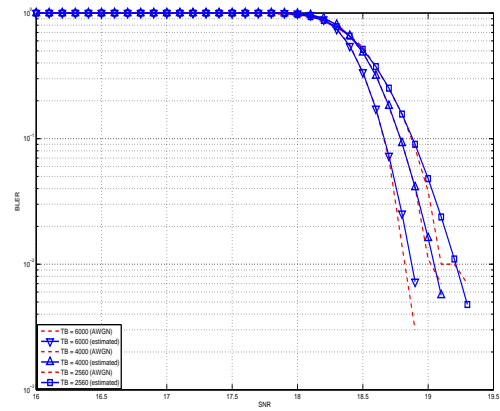

d) MCS28

Fig. 19: BLER for MCS 25, 26, 27 and 28.



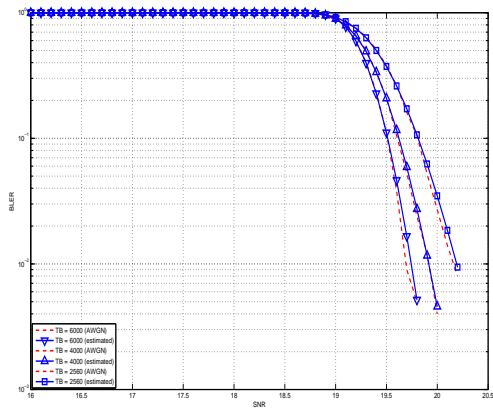

a) MCS29

Fig. 20: BLER for MCS 29.

In case an error occur, the DCIs discarded and therefore the UE will be not able to receive the correspondent Tbs, therefore resulting lost.

## MIMO Model

The use of multiple antennas both at transmitter and receiver side, known as multiple-input and multiple-output (MIMO), is a problem well studied in literature during the past years. Most of the work concentrate on evaluating analytically the gain that the different MIMO schemes might have in term of capacity; however someones provide also information of the gain in terms of received power [CatreuxMIMO].

According to the considerations above, a model more flexible can be obtained considering the gain that MIMO schemes bring in the system from a statistical point of view. As highlighted before, [CatreuxMIMO] presents the statistical gain of several MIMO solutions respect to the SISO one in case of no correlation between the antennas. In the work the gain is presented as the cumulative distribution function (CDF) of the output SINR for what concern SISO, MIMO-Alamouti, MIMO-MMSE, MIMO-OSIC-MMSE and MIMO-ZF schemes. Elaborating the results, the output SINR distribution can be approximated with a log-normal one with different mean and variance as function of the scheme considered. However, the variances are not so different and they are approximatively equal to the one of the SISO mode already included in the shadowing component of the `BuildingsPropagationLossModel`, in detail:

- SISO:  $\mu = 13.5$  and  $\sigma = 20$  [dB].
- MIMO-Alamouti:  $\mu = 17.7$  and  $\sigma = 11.1$  [dB].
- MIMO-MMSE:  $\mu = 10.7$  and  $\sigma = 16.6$  [dB].
- MIMO-OSIC-MMSE:  $\mu = 12.6$  and  $\sigma = 15.5$  [dB].
- MIMO-ZF:  $\mu = 10.3$  and  $\sigma = 12.6$  [dB].

Therefore the PHY layer implements the MIMO model as the gain perceived by the receiver when using a MIMO scheme respect to the one obtained using SISO one. We note that, these gains referred to a case where there is no correlation between the antennas in MIMO scheme; therefore do not model degradation due to paths correlation.

## UE PHY Measurements Model

According to [TS36214], the UE has to report a set of measurements of the eNBs that the device is able to perceive: the reference signal received power (RSRP) and the reference signal received quality (RSRQ). The former is a measure of the received power of a specific eNB, while the latter includes also channel interference and thermal noise. The UE has to report the measurements jointly with the physical cell identity (PCI) of the cell. Both the RSRP and RSRQ measurements are performed during the reception of the RS, while the PCI is obtained with the Primary Synchronization Signal (PSS). The PSS is sent by the eNB each 5 subframes and in detail in the subframes 1 and 6. In real systems, only 504 distinct PCIs are available, and hence it could occur that two nearby eNBs use the same PCI; however, in the simulator we model PCIs using simulation metadata, and we allow up to 65535 distinct PCIs, thereby avoiding PCI collisions provided that less that 65535 eNBs are simulated in the same scenario.

According to [TS36133] sections 9.1.4 and 9.1.7, RSRP is reported by PHY layer in dBm while RSRQ in dB. The values of RSRP and RSRQ are provided to higher layers through the C-PHY SAP (by means of `UeMeasurementsParameters` struct) every 200 ms as defined in [TS36331]. Layer 1 filtering is performed by averaging the all the measurements collected during the last window slot. The periodicity of reporting can be adjusted for research purposes by means of the `LteUePhy::UeMeasurementsFilterPeriod` attribute.

The formulas of the RSRP and RSRQ can be simplified considering the assumption of the PHY layer that the channel is flat within the RB, the finest level of accuracy. In fact, this implies that all the REs within a RB have the same power, therefore:

$$RSRP = \frac{\sum_{k=0}^{K-1} \frac{\sum_{m=0}^{M-1} (P(k,m))}{M}}{K} = \frac{\sum_{k=0}^{K-1} \frac{(M \times P(k))}{M}}{K} = \frac{\sum_{k=0}^{K-1} (P(k))}{K}$$

where  $P(k, m)$  represents the signal power of the RE  $m$  within the RB  $k$ , which, as observed before, is constant within the same RB and equal to  $P(k)$ ,  $M$  is the number of REs carrying the RS in a RB and  $K$  is the number of RBs. It is to be noted that  $P(k)$ , and in general all the powers defined in this section, is obtained in the simulator from the PSD of the RB (which is provided by the `LteInterferencePowerChunkProcessor`), in detail:

$$P(k) = PSD_{RB}(k) * 180000/12$$

where  $PSD_{RB}(k)$  is the power spectral density of the RB  $k$ , 180000 is the bandwidth in Hz of the RB and 12 is the number of REs per RB in an OFDM symbol. Similarly, for RSSI we have

$$RSSI = \frac{\sum_{k=0}^{K-1} \sum_{s=0}^{S-1} \sum_{r=0}^{R-1} (P(k, s, r) + I(k, s, r) + N(k, s, r))}{S}$$

where  $S$  is the number of OFDM symbols carrying RS in a RB and  $R$  is the number of REs carrying a RS in a OFDM symbol (which is fixed to 2) while  $P(k, s, r)$ ,  $I(k, s, r)$  and  $N(k, s, r)$  represent respectively the perceived power of the serving cell, the interference power and the noise power of the RE  $r$  in symbol  $s$ . As for RSRP, the measurements within a RB are always equals among each others according to the PHY model; therefore  $P(k, s, r) = P(k)$ ,  $I(k, s, r) = I(k)$  and  $N(k, s, r) = N(k)$ , which implies that the RSSI can be calculated as:

$$RSSI = \sum_{k=0}^{K-1} \frac{S \times 2 \times (P(k) + I(k) + N(k))}{S} = \sum_{k=0}^{K-1} 2 \times (P(k) + I(k) + N(k))$$

Considering the constraints of the PHY reception chain implementation, and in order to maintain the level of computational complexity low, only RSRP can be directly obtained for all the cells. This is due to the fact that `LteSpectrumPhy` is designed for evaluating the interference only respect to the signal of the serving eNB. This implies that the PHY layer is optimized for managing the power signals information with the serving eNB as a reference. However, RSRP and RSRQ of neighbor cell  $i$  can be extracted by the current information available of the serving cell  $j$  as detailed in the following:

$$RSRP_i = \frac{\sum_{k=0}^{K-1} (P_i(k))}{K}$$

$$RSSI_i = RSSI_j = \sum_{k=0}^{K-1} 2 \times (I_j(k) + P_j(k) + N_j(k))$$

$$RSRQ_i^j = K \times RSRP_i / RSSI_j$$

where  $RSRP_i$  is the RSRP of the neighbor cell  $i$ ,  $P_i(k)$  is the power perceived at any RE within the RB  $k$ ,  $K$  is the total number of RBs,  $RSSI_i$  is the RSSI of the neighbor cell  $i$  when the UE is attached to cell  $j$  (which, since it is the sum of all the received powers, coincides with  $RSSI_j$ ),  $I_j(k)$  is the total interference perceived by UE in any RE of RB  $k$  when attached to cell  $i$  (obtained by the `LteInterferencePowerChunkProcessor`),  $P_j(k)$  is the power perceived of cell  $j$  in any RE of the RB  $k$  and  $N$  is the power noise spectral density in any RE. The sample is considered as valid in case of the RSRQ evaluated is above the `LteUePhy::RsrqUeMeasThreshold` attribute.

## 19.1.6 HARQ

The HARQ scheme implemented is based on a incremental redundancy (IR) solutions combined with multiple stop-and-wait processes for enabling a continuous data flow. In detail, the solution adopted is the *soft combining hybrid IR Full incremental redundancy* (also called IR Type II), which implies that the retransmissions contain only new information respect to the previous ones. The resource allocation algorithm of the HARQ has been implemented within the respective scheduler classes (i.e., `RrFfMacScheduler` and `PffFfMacScheduler`, refer to their correspondent sections for more info), while the decodification part of the HARQ has been implemented in the `LteSpectrumPhy` and `LteHarqPhy` classes which will be detailed in this section.

According to the standard, the UL retransmissions are synchronous and therefore are allocated 7 ms after the original transmission. On the other hand, for the DL, they are asynchronous and therefore can be allocated in a more flexible

way starting from 7 ms and it is a matter of the specific scheduler implementation. The HARQ processes behavior is depicted in Figure:ref:fig-harq-processes-scheme.

At the MAC layer, the HARQ entity residing in the scheduler is in charge of controlling the 8 HARQ processes for generating new packets and managing the retransmissions both for the DL and the UL. The scheduler collects the HARQ feedback from eNB and UE PHY layers (respectively for UL and DL connection) by means of the FF API primitives `SchedUlTriggerReq` and `SchedDlTriggerReq`. According to the HARQ feedback and the RLC buffers status, the scheduler generates a set of DCIs including both retransmissions of HARQ blocks received erroneous and new transmissions, in general, giving priority to the former. On this matter, the scheduler has to take into consideration one constraint when allocating the resource for HARQ retransmissions, it must use the same modulation order of the first transmission attempt (i.e., QPSK for  $MCS \in [0..9]$ , 16QAM for  $MCS \in [10..16]$  and 64QAM for  $MCS \in [17..28]$ ). This restriction comes from the specification of the rate matcher in the 3GPP standard [TS36212], where the algorithm fixes the modulation order for generating the different blocks of the redundancy versions.

The PHY Error Model model (i.e., the `LteMiErrorModel` class already presented before) has been extended for considering IR HARQ according to [wimaxEmd], where the parameters for the AWGN curves mapping for MIESM mapping in case of retransmissions are given by:

$$R_{eff} = \frac{X}{\sum_{i=1}^q C_i}$$

$$M_{I_{eff}} = \frac{\sum_{i=1}^q C_i M_i}{\sum_{i=1}^q C_i}$$

where  $X$  is the number of original information bits,  $C_i$  are number of coded bits,  $M_i$  are the mutual information per HARQ block received on the total number of  $q$  retransmissions. Therefore, in order to be able to return the error probability with the error model implemented in the simulator evaluates the  $R_{eff}$  and the  $M_{I_{eff}}$  and return the value of error probability of the ECR of the same modulation with closest lower rate respect to the  $R_{eff}$ . In order to consider the effect of HARQ retransmissions a new sets of curves have been integrated respect to the standard one used for the original MCS. The new curves are intended for covering the cases when the most conservative MCS of a modulation is used which implies the generation of  $R_{eff}$  lower respect to the one of standard MCSs. On this matter the curves for 1, 2 and 3 retransmissions have been evaluated for 10 and 17. For MCS 0 we considered only the first retransmission since the produced code rate is already very conservative (i.e., 0.04) and returns an error rate enough robust for the reception (i.e., the downturn of the BLER is centered around -18 dB). It is to be noted that, the size of first TB transmission has been assumed as containing all the information bits to be coded; therefore  $X$  is equal to the size of the first TB sent of a an HARQ process. The model assumes that the eventual presence of parity bits in the codewords is already considered in the link level curves. This implies that as soon as the minimum  $R_{eff}$  is reached the model is not including the gain due to the transmission of further parity bits.

The part of HARQ devoted to manage the decodification of the HARQ blocks has been implemented in the `LteHarqPhy` and `LteSpectrumPhy` classes. The former is in charge of maintaining the HARQ information for each active process. The latter interacts with `LteMiErrorModel` class for evaluating the correctness of the blocks received and includes the messaging algorithm in charge of communicating to the HARQ entity in the scheduler the result of the decodifications. These messages are encapsulated in the `dLInfoListElement` for DL and `uLInfoListElement` for UL and sent through the PUCCH and the PHICH respectively with an ideal error free model according to the assumptions in their implementation. A sketch of the iteration between HARQ and LTE protocol stack is represented in Figure:ref:fig-harq-architecture.

Finally, the HARQ engine is always active both at MAC and PHY layer; however, in case of the scheduler does not support HARQ the system will continue to work with the HARQ functions inhibited (i.e., buffers are filled but not used). This implementation characteristic gives backward compatibility with schedulers implemented before HARQ integration.



## 19.1.7 MAC

### Resource Allocation Model

We now briefly describe how resource allocation is handled in LTE, clarifying how it is modeled in the simulator. The scheduler is in charge of generating specific structures called *Data Control Indication* (DCI) which are then transmitted by the PHY of the eNB to the connected UEs, in order to inform them of the resource allocation on a per subframe basis. In doing this in the downlink direction, the scheduler has to fill some specific fields of the DCI structure with all the information, such as: the Modulation and Coding Scheme (MCS) to be used, the MAC Transport Block (TB) size, and the allocation bitmap which identifies which RBs will contain the data transmitted by the eNB to each user.

For the mapping of resources to physical RBs, we adopt a *localized mapping* approach (see [Sesia2009], Section 9.2.2.1); hence in a given subframe each RB is always allocated to the same user in both slots. The allocation bitmap can be coded in different formats; in this implementation, we considered the *Allocation Type 0* defined in [TS36213], according to which the RBs are grouped in Resource Block Groups (RBG) of different size determined as a function of the Transmission Bandwidth Configuration in use.

For certain bandwidth values not all the RBs are usable, since the group size is not a common divisor of the group. This is for instance the case when the bandwidth is equal to 25 RBs, which results in a RBG size of 2 RBs, and therefore 1 RB will result not addressable. In uplink the format of the DCIs is different, since only adjacent RBs can be used because of the SC-FDMA modulation. As a consequence, all RBs can be allocated by the eNB regardless of the bandwidth configuration.

### Adaptive Modulation and Coding

The simulator provides two Adaptive Modulation and Coding (AMC) models: one based on the GSoC model [Piro2011] and one based on the physical error model (described in the following sections).

The former model is a modified version of the model described in [Piro2011], which in turn is inspired from [Seo2004]. Our version is described in the following. Let  $i$  denote the generic user, and let  $\gamma_i$  be its SINR. We get the spectral efficiency  $\eta_i$  of user  $i$  using the following equations:

$$\begin{aligned} \text{BER} &= 0.00005 \\ \Gamma &= \frac{-\ln(5 * \text{BER})}{1.5} \\ \eta_i &= \log_2 \left( 1 + \frac{\gamma_i}{\Gamma} \right) \end{aligned}$$

The procedure described in [R1-081483] is used to get the corresponding MCS scheme. The spectral efficiency is quantized based on the channel quality indicator (CQI), rounding to the lowest value, and is mapped to the corresponding MCS scheme.

Finally, we note that there are some discrepancies between the MCS index in [R1-081483] and that indicated by the standard: [TS36213] Table 7.1.7.1-1 says that the MCS index goes from 0 to 31, and 0 appears to be a valid MCS scheme (TB size is not 0) but in [R1-081483] the first useful MCS index is 1. Hence to get the value as intended by the standard we need to subtract 1 from the index reported in [R1-081483].

The alternative model is based on the physical error model developed for this simulator and explained in the following subsections. This scheme is able to adapt the MCS selection to the actual PHY layer performance according to the specific CQI report. According to their definition, a CQI index is assigned when a single PDSCH TB with the modulation coding scheme and code rate correspondent to that CQI index in table 7.2.3-1 of [TS36213] can be received with an error probability less than 0.1. In case of wideband CQIs, the reference TB includes all the RBGs available in order to have a reference based on the whole available resources; while, for subband CQIs, the reference TB is sized as the RBGs.

## Transport Block model

The model of the MAC Transport Blocks (TBs) provided by the simulator is simplified with respect to the 3GPP specifications. In particular, a simulator-specific class (PacketBurst) is used to aggregate MAC SDUs in order to achieve the simulator's equivalent of a TB, without the corresponding implementation complexity. The multiplexing of different logical channels to and from the RLC layer is performed using a dedicated packet tag (LteRadioBearerTag), which performs a functionality which is partially equivalent to that of the MAC headers specified by 3GPP.

## The FemtoForum MAC Scheduler Interface

This section describes the ns-3 specific version of the LTE MAC Scheduler Interface Specification published by the FemtoForum [FFAPI].

We implemented the ns-3 specific version of the FemtoForum MAC Scheduler Interface [FFAPI] as a set of C++ abstract classes; in particular, each primitive is translated to a C++ method of a given class. The term *implemented* here is used with the same meaning adopted in [FFAPI], and hence refers to the process of translating the logical interface specification to a particular programming language. The primitives in [FFAPI] are grouped in two groups: the CSCHED primitives, which deal with scheduler configuration, and the SCHED primitives, which deal with the execution of the scheduler. Furthermore, [FFAPI] defines primitives of two different kinds: those of type REQ go from the MAC to the Scheduler, and those of type IND/CNF go from the scheduler to the MAC. To translate these characteristics into C++, we define the following abstract classes that implement Service Access Points (SAPs) to be used to issue the primitives:

- the `FfMacSchedSapProvider` class defines all the C++ methods that correspond to SCHED primitives of type REQ;
- the `FfMacSchedSapUser` class defines all the C++ methods that correspond to SCHED primitives of type CNF/IND;
- the `FfMacCschedSapProvider` class defines all the C++ methods that correspond to CSCHED primitives of type REQ;
- the `FfMacCschedSapUser` class defines all the C++ methods that correspond to CSCHED primitives of type CNF/IND;

There are 3 blocks involved in the MAC Scheduler interface: Control block, Subframe block and Scheduler block. Each of these blocks provide one part of the MAC Scheduler interface. The figure below shows the relationship between the blocks and the SAPs defined in our implementation of the MAC Scheduler Interface.

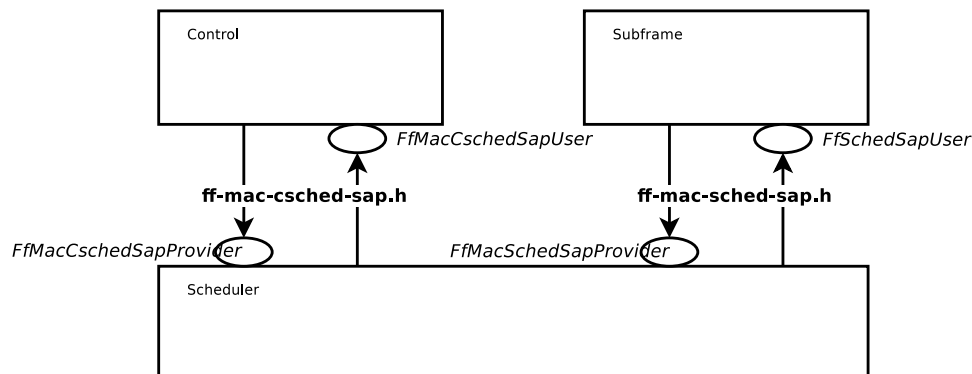

In addition to the above principles, the following design choices have been taken:

- The definition of the MAC Scheduler interface classes follows the naming conventions of the *ns-3* Coding Style. In particular, we follow the CamelCase convention for the primitive names. For example, the primitive `CSCHED_CELL_CONFIG_REQ` is translated to `CschedCellConfigReq` in the *ns-3* code.

- The same naming conventions are followed for the primitive parameters. As the primitive parameters are member variables of classes, they are also prefixed with a `m_`.
- regarding the use of vectors and lists in data structures, we note that [FFAPI] is a pretty much C-oriented API. However, considered that C++ is used in ns-3, and that the use of C arrays is discouraged, we used STL vectors (`std::vector`) for the implementation of the MAC Scheduler Interface, instead of using C arrays as implicitly suggested by the way [FFAPI] is written.
- In C++, members with constructors and destructors are not allowed in unions. Hence all those data structures that are said to be unions in [FFAPI] have been defined as structs in our code.

The figure below shows how the MAC Scheduler Interface is used within the eNB.

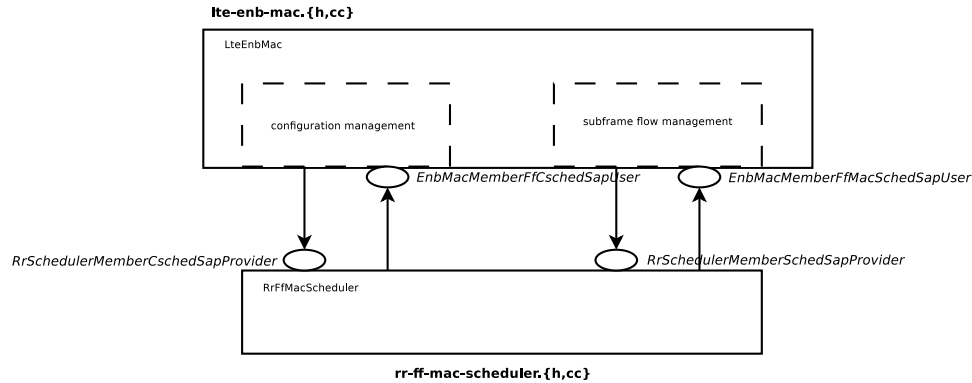

The User side of both the CSCHED SAP and the SCHED SAP are implemented within the eNB MAC, i.e., in the file `lte-enb-mac.cc`. The eNB MAC can be used with different scheduler implementations without modifications. The same figure also shows, as an example, how the Round Robin scheduler is implemented: to interact with the MAC of the eNB, the Round Robin scheduler implements the Provider side of the SCHED SAP and CSCHED SAP interfaces. A similar approach can be used to implement other schedulers as well. A description of each of the scheduler implementations that we provide as part of our LTE simulation module is provided in the following subsections.

## Round Robin (RR) Scheduler

The Round Robin (RR) scheduler is probably the simplest scheduler found in the literature. It works by dividing the available resources among the active flows, i.e., those logical channels which have a non-empty RLC queue. If the number of RBGs is greater than the number of active flows, all the flows can be allocated in the same subframe. Otherwise, if the number of active flows is greater than the number of RBGs, not all the flows can be scheduled in a given subframe; then, in the next subframe the allocation will start from the last flow that was not allocated. The MCS to be adopted for each user is done according to the received wideband CQIs.

For what concern the HARQ, RR implements the non adaptive version, which implies that in allocating the retransmission attempts RR uses the same allocation configuration of the original block, which means maintaining the same RBGs and MCS. UEs that are allocated for HARQ retransmissions are not considered for the transmission of new data in case they have a transmission opportunity available in the same TTI. Finally, HARQ can be disabled with ns3 attribute system for maintaining backward compatibility with old test cases and code, in detail:

```
Config::SetDefault ("ns3::RrFfMacScheduler::HarqEnabled", BooleanValue (false));
```

The scheduler implements the filtering of the uplink CQIs according to their nature with `UlcqiFilter` attribute, in detail:

- `SRS_UL_CQI`: only SRS based CQI are stored in the internal attributes.
- `PUSCH_UL_CQI`: only PUSCH based CQI are stored in the internal attributes.



## Proportional Fair (PF) Scheduler

The Proportional Fair (PF) scheduler [Sesia2009] works by scheduling a user when its instantaneous channel quality is high relative to its own average channel condition over time. Let  $i, j$  denote generic users; let  $t$  be the subframe index, and  $k$  be the resource block index; let  $M_{i,k}(t)$  be MCS usable by user  $i$  on resource block  $k$  according to what reported by the AMC model (see *Adaptive Modulation and Coding*); finally, let  $S(M, B)$  be the TB size in bits as defined in [TS36213] for the case where a number  $B$  of resource blocks is used. The achievable rate  $R_i(k, t)$  in bit/s for user  $i$  on resource block group  $k$  at subframe  $t$  is defined as

$$R_i(k, t) = \frac{S(M_{i,k}(t), 1)}{\tau}$$

where  $\tau$  is the TTI duration. At the start of each subframe  $t$ , each RBG is assigned to a certain user. In detail, the index  $\hat{i}_k(t)$  to which RBG  $k$  is assigned at time  $t$  is determined as

$$\hat{i}_k(t) = \operatorname{argmax}_{j=1, \dots, N} \left( \frac{R_j(k, t)}{T_j(t)} \right)$$

where  $T_j(t)$  is the past throughput performance perceived by the user  $j$ . According to the above scheduling algorithm, a user can be allocated to different RBGs, which can be either adjacent or not, depending on the current condition of the channel and the past throughput performance  $T_j(t)$ . The latter is determined at the end of the subframe  $t$  using the following exponential moving average approach:

$$T_j(t) = \left(1 - \frac{1}{\alpha}\right)T_j(t-1) + \frac{1}{\alpha}\hat{T}_j(t)$$

where  $\alpha$  is the time constant (in number of subframes) of the exponential moving average, and  $\hat{T}_j(t)$  is the actual throughput achieved by the user  $i$  in the subframe  $t$ .  $\hat{T}_j(t)$  is measured according to the following procedure. First we determine the MCS  $\hat{M}_j(t)$  actually used by user  $j$ :

$$\hat{M}_j(t) = \min_{k: \hat{i}_k(t)=j} M_{j,k}(t)$$

then we determine the total number  $\hat{B}_j(t)$  of RBGs allocated to user  $j$ :

$$\hat{B}_j(t) = \left| \{k : \hat{i}_k(t) = j\} \right|$$

where  $|\cdot|$  indicates the cardinality of the set; finally,

$$\hat{T}_j(t) = \frac{S(\hat{M}_j(t), \hat{B}_j(t))}{\tau}$$

For what concern the HARQ, PF implements the non adaptive version, which implies that in allocating the retransmission attempts the scheduler uses the same allocation configuration of the original block, which means maintaining the same RBGs and MCS. UEs that are allocated for HARQ retransmissions are not considered for the transmission of new data in case they have a transmission opportunity available in the same TTI. Finally, HARQ can be disabled with ns3 attribute system for maintaining backward compatibility with old test cases and code, in detail:

```
Config::SetDefault ("ns3::PffMacScheduler::HarqEnabled", BooleanValue (false));
```

## Maximum Throughput (MT) Scheduler

The Maximum Throughput (MT) scheduler [FCapo2012] aims to maximize the overall throughput of eNB. It allocates each RB to the user that can achieve the maximum achievable rate in the current TTI. Currently, MT scheduler in

NS-3 has two versions: frequency domain (FDMT) and time domain (TDMT). In FDMT, every TTI, MAC scheduler allocates RBGs to the UE who has highest achievable rate calculated by subband CQI. In TDMT, every TTI, MAC scheduler selects one UE which has highest achievable rate calculated by wideband CQI. Then MAC scheduler allocates all RBGs to this UE in current TTI. The calculation of achievable rate in FDMT and TDMT is as same as the one in PF. Let  $i, j$  denote generic users; let  $t$  be the subframe index, and  $k$  be the resource block index; let  $M_{i,k}(t)$  be MCS usable by user  $i$  on resource block  $k$  according to what reported by the AMC model (see *Adaptive Modulation and Coding*); finally, let  $S(M, B)$  be the TB size in bits as defined in [TS36213] for the case where a number  $B$  of resource blocks is used. The achievable rate  $R_i(k, t)$  in bit/s for user  $i$  on resource block  $k$  at subframe  $t$  is defined as

$$R_i(k, t) = \frac{S(M_{i,k}(t), 1)}{\tau}$$

where  $\tau$  is the TTI duration. At the start of each subframe  $t$ , each RB is assigned to a certain user. In detail, the index  $\hat{i}_k(t)$  to which RB  $k$  is assigned at time  $t$  is determined as

$$\hat{i}_k(t) = \operatorname{argmax}_{j=1, \dots, N} (R_j(k, t))$$

When there are several UEs having the same achievable rate, current implementation always selects the first UE created in script. Although MT can maximize cell throughput, it cannot provide fairness to UEs in poor channel condition.

### Throughput to Average (TTA) Scheduler

The Throughput to Average (TTA) scheduler [FCapo2012] can be considered as an intermediate between MT and PF. The metric used in TTA is calculated as follows:

$$\hat{i}_k(t) = \operatorname{argmax}_{j=1, \dots, N} \left( \frac{R_j(k, t)}{R_j(t)} \right)$$

Here,  $R_i(k, t)$  in bit/s represents the achievable rate for user  $i$  on resource block  $k$  at subframe  $t$ . The calculation method already is shown in MT and PF. Meanwhile,  $R_i(t)$  in bit/s stands for the achievable rate for  $i$  at subframe  $t$ . The difference between those two achievable rates is how to get MCS. For  $R_i(k, t)$ , MCS is calculated by subband CQI while  $R_i(t)$  is calculated by wideband CQI. TTA scheduler can only be implemented in frequency domain (FD) because the achievable rate of particular RBG is only related to FD scheduling.

### Blind Average Throughput Scheduler

The Blind Average Throughput scheduler [FCapo2012] aims to provide equal throughput to all UEs under eNB. The metric used in TTA is calculated as follows:

$$\hat{i}_k(t) = \operatorname{argmax}_{j=1, \dots, N} \left( \frac{1}{T_j(t)} \right)$$

where  $T_j(t)$  is the past throughput performance perceived by the user  $j$  and can be calculated by the same method in PF scheduler. In the time domain blind average throughput (TD-BET), the scheduler selects the UE with largest priority metric and allocates all RBGs to this UE. On the other hand, in the frequency domain blind average throughput (FD-BET), every TTI, the scheduler first selects one UE with lowest pastAverageThroughput (largest priority metric). Then scheduler assigns one RBG to this UE, it calculates expected throughput of this UE and uses it to compare with past average throughput  $T_j(t)$  of other UEs. The scheduler continues to allocate RBG to this UE until its expected throughput is not the smallest one among past average throughput  $T_j(t)$  of all UE. Then the scheduler will use the same way to allocate RBG for a new UE which has the lowest past average throughput  $T_j(t)$  until all RBGs are allocated to UEs. The principle behind this is that, in every TTI, the scheduler tries the best to achieve the equal throughput among all UEs.

## Token Bank Fair Queue Scheduler

Token Bank Fair Queue (TBFQ) is a QoS aware scheduler which derives from the leaky-bucket mechanism. In TBFQ, a traffic flow of user  $i$  is characterized by following parameters:

- $t_i$ : packet arrival rate (byte/sec )
- $r_i$ : token generation rate (byte/sec)
- $p_i$ : token pool size (byte)
- $E_i$ : counter that records the number of token borrowed from or given to the token bank by flow  $i$  ;  $E_i$  can be smaller than zero

Each  $K$  bytes data consumes  $k$  tokens. Also, TBFQ maintains a shared token bank ( $B$ ) so as to balance the traffic between different flows. If token generation rate  $r_i$  is bigger than packet arrival rate  $t_i$ , then tokens overflowing from token pool are added to the token bank, and  $E_i$  is increased by the same amount. Otherwise, flow  $i$  needs to withdraw tokens from token bank based on a priority metric  $frac{E_i r_i}{p_i}$ , and  $E_i$  is decreased. Obviously, the user contributes more on token bank has higher priority to borrow tokens; on the other hand, the user borrows more tokens from bank has lower priority to continue to withdraw tokens. Therefore, in case of several users having the same token generation rate, traffic rate and token pool size, user suffers from higher interference has more opportunity to borrow tokens from bank. In addition, TBFQ can police the traffic by setting the token generation rate to limit the throughput. Additionally, TBFQ also maintains following three parameters for each flow:

- Debt limit  $d_i$ : if  $E_i$  belows this threshold, user  $i$  cannot further borrow tokens from bank. This is for preventing malicious UE to borrow too much tokens.
- Credit limit  $c_i$ : the maximum number of tokens UE  $i$  can borrow from the bank in one time.
- Credit threshold  $C$ : once  $E_i$  reaches debt limit, UE  $i$  must store  $C$  tokens to bank in order to further borrow token from bank.

LTE in NS-3 has two versions of TBFQ scheduler: frequency domain TBFQ (FD-TBFQ) and time domain TBFQ (TD-TBFQ). In FD-TBFQ, the scheduler always select UE with highest metric and allocates RBG with highest subband CQI until there are no packets within UE's RLC buffer or all RBGs are allocated [FABokhari2009]. In TD-TBFQ, after selecting UE with maximum metric, it allocates all RBGs to this UE by using wideband CQI [WKWong2004].

## Priority Set Scheduler

Priority set scheduler (PSS) is a QoS aware scheduler which combines time domain (TD) and frequency domain (FD) packet scheduling operations into one scheduler [GMonghal2008]. It controls the fairness among UEs by a specified Target Bit Rate (TBR).

In TD scheduler part, PSS first selects UEs with non-empty RLC buffer and then divide them into two sets based on the TBR:

- set 1: UE whose past average throughput is smaller than TBR; TD scheduler calculates their priority metric in Blind Equal Throughput (BET) style:

$$\hat{i}_k(t) = \operatorname{argmax}_{j=1,\dots,N} \left( \frac{1}{T_j(t)} \right)$$

- set 2: UE whose past average throughput is larger (or equal) than TBR; TD scheduler calculates their priority metric in Proportional Fair (PF) style:

$$\hat{i}_k(t) = \operatorname{argmax}_{j=1,\dots,N} \left( \frac{R_j(k,t)}{T_j(t)} \right)$$

UEs belonged to set 1 have higher priority than ones in set 2. Then PSS will select  $N_{max}$  UEs with highest metric in two sets and forward those UE to FD scheduler. In PSS, FD scheduler allocates RBG  $k$  to UE  $n$  that maximums the chosen metric. Two PF schedulers are used in PF scheduler:

- Proportional Fair scheduled (PFsch)

$$\widehat{Msch}_k(t) = \operatorname{argmax}_{j=1,\dots,N} \left( \frac{R_j(k,t)}{Tsch_j(t)} \right)$$

- Carrier over Interference to Average (CoIta)

$$\widehat{Mcoi}_k(t) = \operatorname{argmax}_{j=1,\dots,N} \left( \frac{CoI[j,k]}{\sum_{k=0}^{N_{RBG}} CoI[j,k]} \right)$$

where  $Tsch_j(t)$  is similar past throughput performance perceived by the user  $j$ , with the difference that it is updated only when the  $i$ -th user is actually served.  $CoI[j,k]$  is an estimation of the SINR on the RBG  $k$  of UE  $j$ . Both PFsch and CoIta is for decoupling FD metric from TD scheduler. In addition, PSS FD scheduler also provide a weight metric  $W[n]$  for helping controlling fairness in case of low number of UEs.

$$W[n] = \max\left(1, \frac{TBR}{T_j(t)}\right)$$

where  $T_j(t)$  is the past throughput performance perceived by the user  $j$ . Therefore, on RBG  $k$ , the FD scheduler selects the UE  $j$  that maximizes the product of the frequency domain metric ( $Msch, MCoI$ ) by weight  $W[n]$ . This strategy will guarantee the throughput of lower quality UE tend towards the TBR.

```
Config::SetDefault ("ns3::PffMacScheduler::HarqEnabled", BooleanValue (false));
```

The scheduler implements the filtering of the uplink CQIs according to their nature with `ULCqiFilter` attribute, in detail:

- `SRS_UL_CQI`: only SRS based CQI are stored in the internal attributes.
- `PUSCH_UL_CQI`: only PUSCH based CQI are stored in the internal attributes.

## Channel and QoS Aware Scheduler

The Channel and QoS Aware (CQA) Scheduler [Bbojovic2014] is an LTE MAC downlink scheduling algorithm that considers the head of line (HOL) delay, the GBR parameters and channel quality over different subbands. The CQA scheduler is based on joint TD and FD scheduling.

In the TD (at each TTI) the CQA scheduler groups users by priority. The purpose of grouping is to enforce the FD scheduling to consider first the flows with highest HOL delay. The grouping metric  $m_{td}$  for user  $j = 1, \dots, N$  is defined in the following way:

$$m_{td}^j(t) = \lceil \frac{d_{hol}^j(t)}{g} \rceil,$$

where  $d_{hol}^j(t)$  is the current value of HOL delay of flow  $j$ , and  $g$  is a grouping parameter that determines granularity of the groups, i.e. the number of the flows that will be considered in the FD scheduling iteration.

The groups of flows selected in the TD iteration are forwarded to the FD scheduling starting from the flows with the highest value of the  $m_{td}$  metric until all RBGs are assigned in the corresponding TTI. In the FD, for each RBG  $k = 1, \dots, K$ , the CQA scheduler assigns the current RBG to the user  $j$  that has the maximum value of the FD metric which we define in the following way:

$$m_{fd}^{(k,j)}(t) = d_{HOL}^j(t) \cdot m_{GBR}^j(t) \cdot m_{ca}^{k,j}(t),$$

where  $m_{GBR}^j(t)$  is calculated as follows:

$$m_{GBR}^j(t) = \frac{GBR^j}{R^j(t)} = \frac{GBR^j}{(1-\alpha) \cdot R^j(t-1) + \alpha \cdot r^j(t)},$$

where  $GBR^j$  is the bit rate specified in EPS bearer of the flow  $j$ ,  $\overline{R^j}(t)$  is the past averaged throughput that is calculated with a moving average,  $r^j(t)$  is the throughput achieved at the time  $t$ , and  $\alpha$  is a coefficient such that  $0 \leq \alpha \leq 1$ .

For  $m_{ca}^{(k,j)}(t)$  we consider two different metrics:  $m_{pf}^{(k,j)}(t)$  and  $m_{ff}^{(k,j)}(t)$ .  $m_{pf}$  is the Proportional Fair metric which is defined as follows:

$$m_{pf}^{(k,j)}(t) = \frac{R_e^{(k,j)}}{\overline{R^j}(t)},$$

where  $R_e^{(k,j)}(t)$  is the estimated achievable throughput of user  $j$  over RBG  $k$  calculated by the Adaptive Modulation and Coding (AMC) scheme that maps the channel quality indicator (CQI) value to the transport block size in bits.

The other channel awareness metric that we consider is  $m_{ff}$  which is proposed in [GMonghal2008] and it represents the frequency selective fading gains over RBG  $k$  for user  $j$  and is calculated in the following way:

$$m_{ff}^{(k,j)}(t) = \frac{CQI^{(k,j)}(t)}{\sum_{k=1}^K CQI(t)^{(k,j)}},$$

where  $CQI^{(k,j)}(t)$  is the last reported CQI value from user  $j$  for the  $k$ -th RBG.

The user can select whether  $m_{pf}$  or  $m_{ff}$  is used by setting the attribute `ns3::CqaFfMacScheduler::CqaMetric` respectively to "CqaPf" or "CqaFf".

## Random Access

The LTE model includes a model of the Random Access procedure based on some simplifying assumptions, which are detailed in the following for each of the messages and signals described in the specs [TS36321].

- **Random Access (RA) preamble:** in real LTE systems this corresponds to a Zadoff-Chu (ZC) sequence using one of several formats available and sent in the PRACH slots which could in principle overlap with PUSCH. PRACH Configuration Index 14 is assumed, i.e., preambles can be sent on any system frame number and subframe number. The RA preamble is modeled using the `LteControlMessage` class, i.e., as an ideal message that does not consume any radio resources. The collision of preamble transmission by multiple UEs in the same cell are modeled using a protocol interference model, i.e., whenever two or more identical preambles are transmitted in same cell at the same TTI, no one of these identical preambles will be received by the eNB. Other than this collision model, no error model is associated with the reception of a RA preamble.
- **Random Access Response (RAR):** in real LTE systems, this is a special MAC PDU sent on the DL-SCH. Since MAC control elements are not accurately modeled in the simulator (only RLC and above PDUs are), the RAR is modeled as an `LteControlMessage` that does not consume any radio resources. Still, during the RA procedure, the `LteEnbMac` will request to the scheduler the allocation of resources for the RAR using the FF MAC Scheduler primitive `SCHED_DL_RACH_INFO_REQ`. Hence, an enhanced scheduler implementation (not available at the moment) could allocate radio resources for the RAR, thus modeling the consumption of Radio Resources for the transmission of the RAR.
- **Message 3:** in real LTE systems, this is an RLC TM SDU sent over resources specified in the UL Grant in the RAR. In the simulator, this is modeled as a real RLC TM RLC PDU whose UL resources are allocated by the scheduler upon call to `SCHED_DL_RACH_INFO_REQ`.
- **Contention Resolution (CR):** in real LTE system, the CR phase is needed to address the case where two or more UE sent the same RA preamble in the same TTI, and the eNB was able to detect this preamble in spite of the collision. Since this event does not occur due to the protocol interference model used for the reception of RA preambles, the CR phase is not modeled in the simulator, i.e., the CR MAC CE is never sent by the eNB and the UEs consider the RA to be successful upon reception of the RAR. As a consequence, the radio resources consumed for the transmission of the CR MAC CE are not modeled.

Figure *Sequence diagram of the Contention-based MAC Random Access procedure and Sequence diagram of the Non-contention-based MAC Random Access procedure* shows the sequence diagrams of respectively the contention-based and non-contention-based MAC random access procedure, highlighting the interactions between the MAC and the other entities.

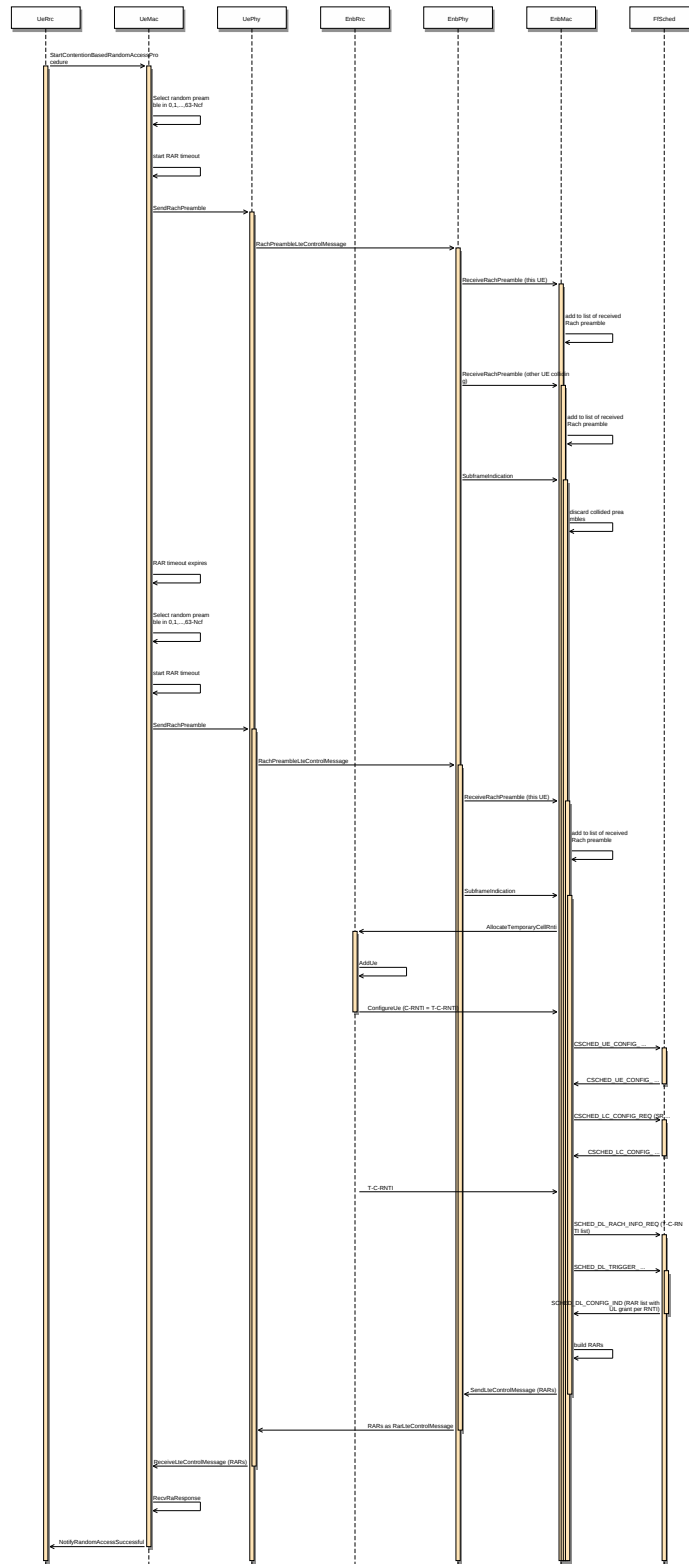

Fig. 23: Sequence diagram of the Contention-based MAC Random Access procedure

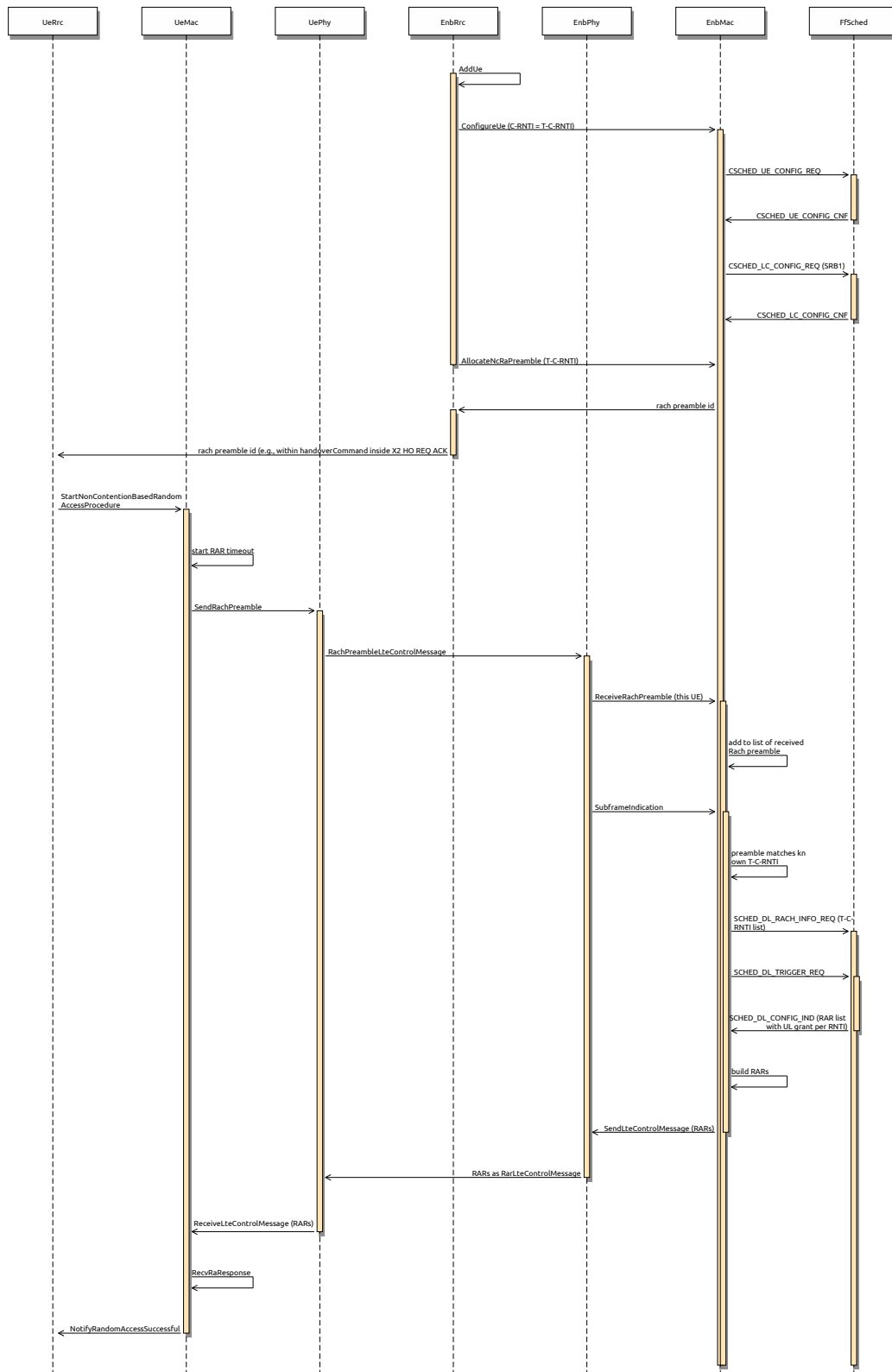

Fig. 24: Sequence diagram of the Non-contention-based MAC Random Access procedure



## 19.1.8 RLC

### Overview

The RLC entity is specified in the 3GPP technical specification [TS36322], and comprises three different types of RLC: Transparent Mode (TM), Unacknowledged Mode (UM) and Acknowledged Mode (AM). The simulator includes one model for each of these entities

The RLC entities provide the RLC service interface to the upper PDCP layer and the MAC service interface to the lower MAC layer. The RLC entities use the PDCP service interface from the upper PDCP layer and the MAC service interface from the lower MAC layer.

Figure *Implementation Model of PDCP, RLC and MAC entities and SAPs* shows the implementation model of the RLC entities and its relationship with all the other entities and services in the protocol stack.

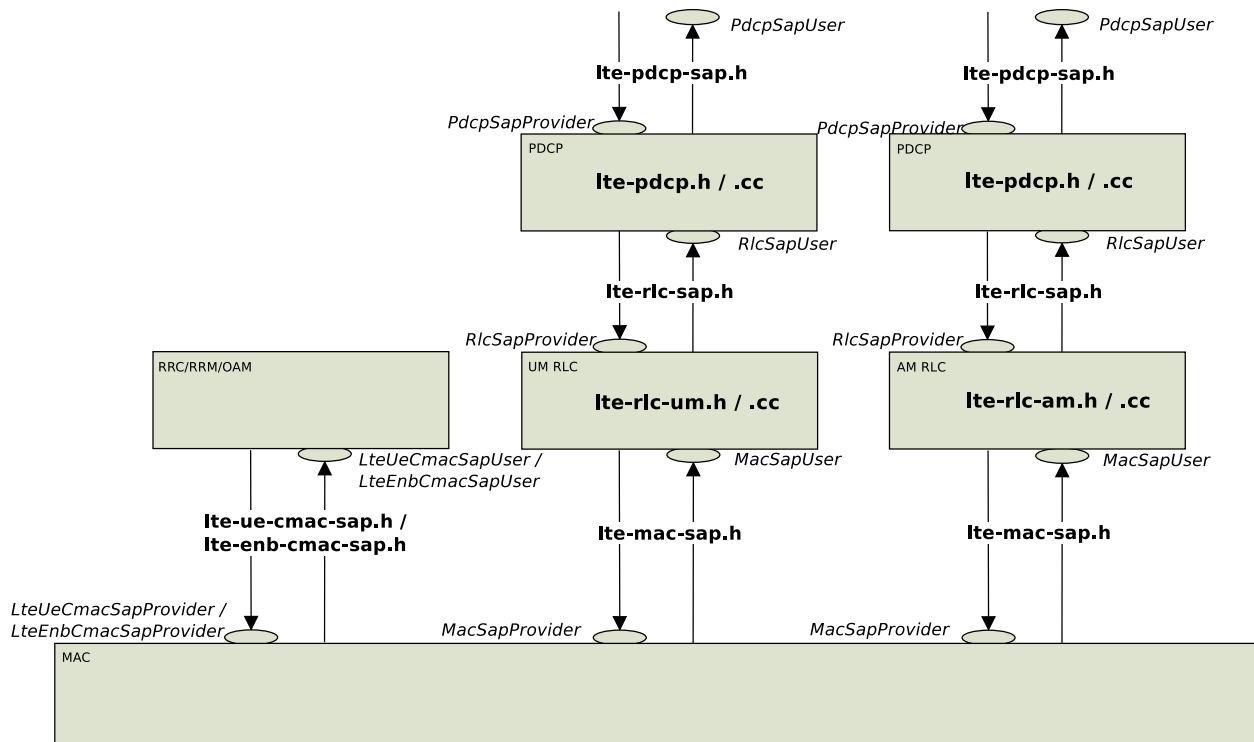

Fig. 25: Implementation Model of PDCP, RLC and MAC entities and SAPs

### Service Interfaces

#### RLC Service Interface

The RLC service interface is divided into two parts:

- the `RlcSapProvider` part is provided by the RLC layer and used by the upper PDCP layer and
- the `RlcSapUser` part is provided by the upper PDCP layer and used by the RLC layer.

Both the UM and the AM RLC entities provide the same RLC service interface to the upper PDCP layer.

## RLC Service Primitives

The following list specifies which service primitives are provided by the RLC service interfaces:

- `RlcSapProvider::TransmitPdcPdu`
  - The PDCP entity uses this primitive to send a PDCP PDU to the lower RLC entity in the transmitter peer
- `RlcSapUser::ReceivePdcPdu`
  - The RLC entity uses this primitive to send a PDCP PDU to the upper PDCP entity in the receiver peer

## MAC Service Interface

The MAC service interface is divided into two parts:

- the `MacSapProvider` part is provided by the MAC layer and used by the upper RLC layer and
- the `MacSapUser` part is provided by the upper RLC layer and used by the MAC layer.

## MAC Service Primitives

The following list specifies which service primitives are provided by the MAC service interfaces:

- `MacSapProvider::TransmitPdu`
  - The RLC entity uses this primitive to send a RLC PDU to the lower MAC entity in the transmitter peer
- `MacSapProvider::ReportBufferStatus`
  - The RLC entity uses this primitive to report the MAC entity the size of pending buffers in the transmitter peer
- `MacSapUser::NotifyTxOpportunity`
  - The MAC entity uses this primitive to notify the RLC entity a transmission opportunity
- `MacSapUser::ReceivePdu`
  - The MAC entity uses this primitive to send an RLC PDU to the upper RLC entity in the receiver peer

## AM RLC

The processing of the data transfer in the Acknowledge Mode (AM) RLC entity is explained in section 5.1.3 of [TS36322]. In this section we describe some details of the implementation of the RLC entity.

### Buffers for the transmit operations

Our implementation of the AM RLC entity maintains 3 buffers for the transmit operations:

- **Transmission Buffer:** it is the RLC SDU queue. When the AM RLC entity receives a SDU in the `TransmitPdcPdu` service primitive from the upper PDCP entity, it enqueues it in the Transmission Buffer. We put a limit on the RLC buffer size and just silently drop SDUs when the buffer is full.
- **Transmitted PDUs Buffer:** it is the queue of transmitted RLC PDUs for which an ACK/NACK has not been received yet. When the AM RLC entity sends a PDU to the MAC entity, it also puts a copy of the transmitted PDU in the Transmitted PDUs Buffer.

- **Retransmission Buffer:** it is the queue of RLC PDUs which are considered for retransmission (i.e., they have been NACKed). The AM RLC entity moves this PDU to the Retransmission Buffer, when it retransmits a PDU from the Transmitted Buffer.

### Transmit operations in downlink

The following sequence diagram shows the interactions between the different entities (RRC, PDCP, AM RLC, MAC and MAC scheduler) of the eNB in the downlink to perform data communications.

Figure *Sequence diagram of data PDU transmission in downlink* shows how the upper layers send data PDUs and how the data flow is processed by the different entities/services of the LTE protocol stack.

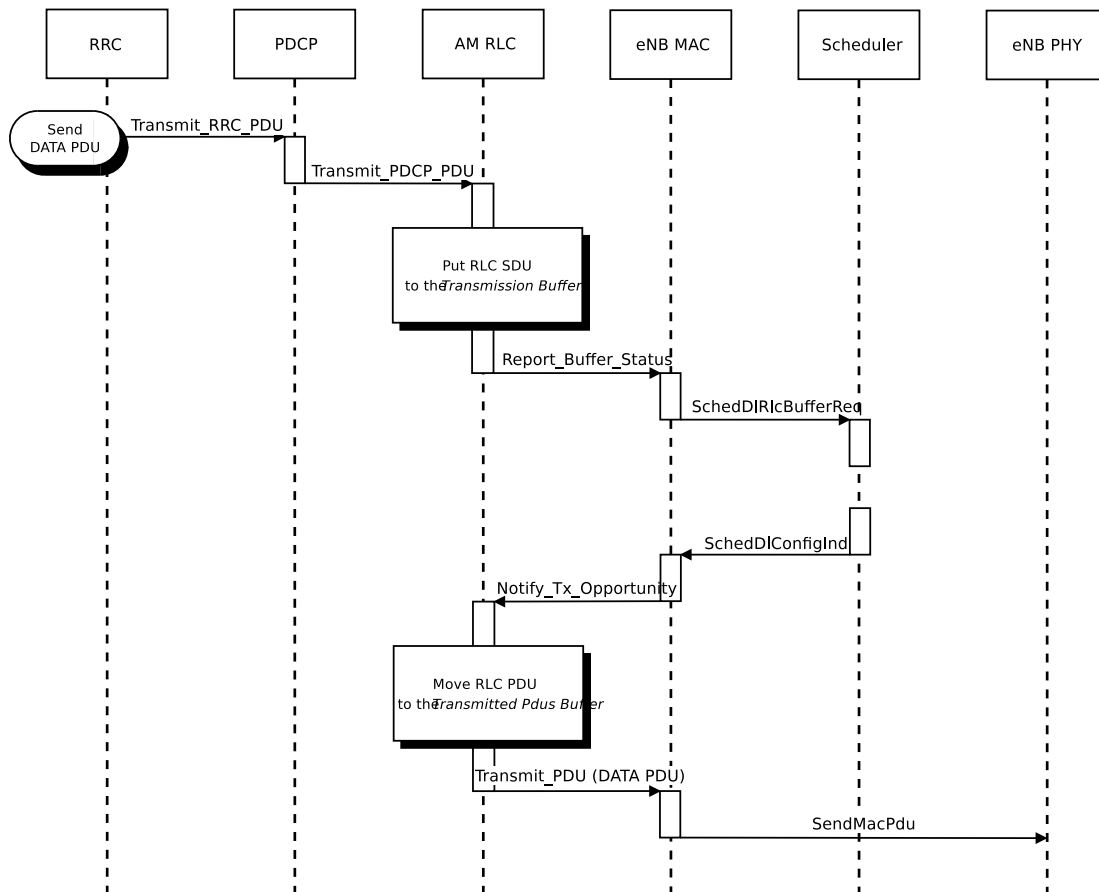

Fig. 26: Sequence diagram of data PDU transmission in downlink

The PDCP entity calls the `Transmit_PDCP_PDU` service primitive in order to send a data PDU. The AM RLC entity processes this service primitive according to the AM data transfer procedures defined in section 5.1.3 of [TS36322].

When the `Transmit_PDCP_PDU` service primitive is called, the AM RLC entity performs the following operations:

- Put the data SDU in the Transmission Buffer.
- Compute the size of the buffers (how the size of buffers is computed will be explained afterwards).
- Call the `Report_Buffer_Status` service primitive of the eNB MAC entity in order to notify to the eNB MAC entity the sizes of the buffers of the AM RLC entity. Then, the eNB MAC entity updates the buffer status in the MAC scheduler using the `SchedDIRlcBufferReq` service primitive of the FF MAC Scheduler API.

Afterwards, when the MAC scheduler decides that some data can be sent, the MAC entity notifies it to the RLC entity, i.e. it calls the `Notify_Tx_Opportunity` service primitive, then the AM RLC entity does the following:

- Create a single data PDU by segmenting and/or concatenating the SDUs in the Transmission Buffer.
- Move the data PDU from the Transmission Buffer to the Transmitted PDUs Buffer.
- Update state variables according section 5.1.3.1.1 of [TS36322].
- Call the `Transmit_PDU` primitive in order to send the data PDU to the MAC entity.

### Retransmission in downlink

The sequence diagram of Figure *Sequence diagram of data PDU retransmission in downlink* shows the interactions between the different entities (AM RLC, MAC and MAC scheduler) of the eNB in downlink when data PDUs must be retransmitted by the AM RLC entity.

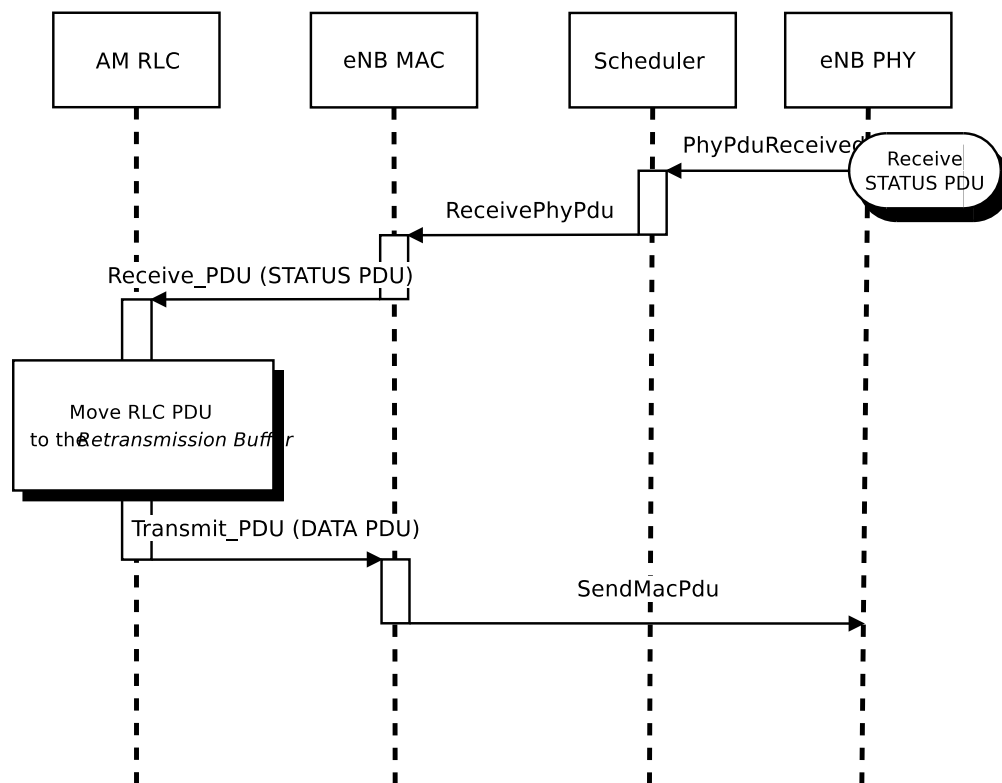

Fig. 27: Sequence diagram of data PDU retransmission in downlink

The transmitting AM RLC entity can receive STATUS PDUs from the peer AM RLC entity. STATUS PDUs are sent according section 5.3.2 of [TS36322] and the processing of reception is made according section 5.2.1 of [TS36322].

When a data PDU is retransmitted from the Transmitted PDUs Buffer, it is also moved to the Retransmission Buffer.

### Transmit operations in uplink

The sequence diagram of Figure *Sequence diagram of data PDU transmission in uplink* shows the interactions between the different entities of the UE (RRC, PDCP, RLC and MAC) and the eNB (MAC and Scheduler) in uplink when data PDUs are sent by the upper layers.

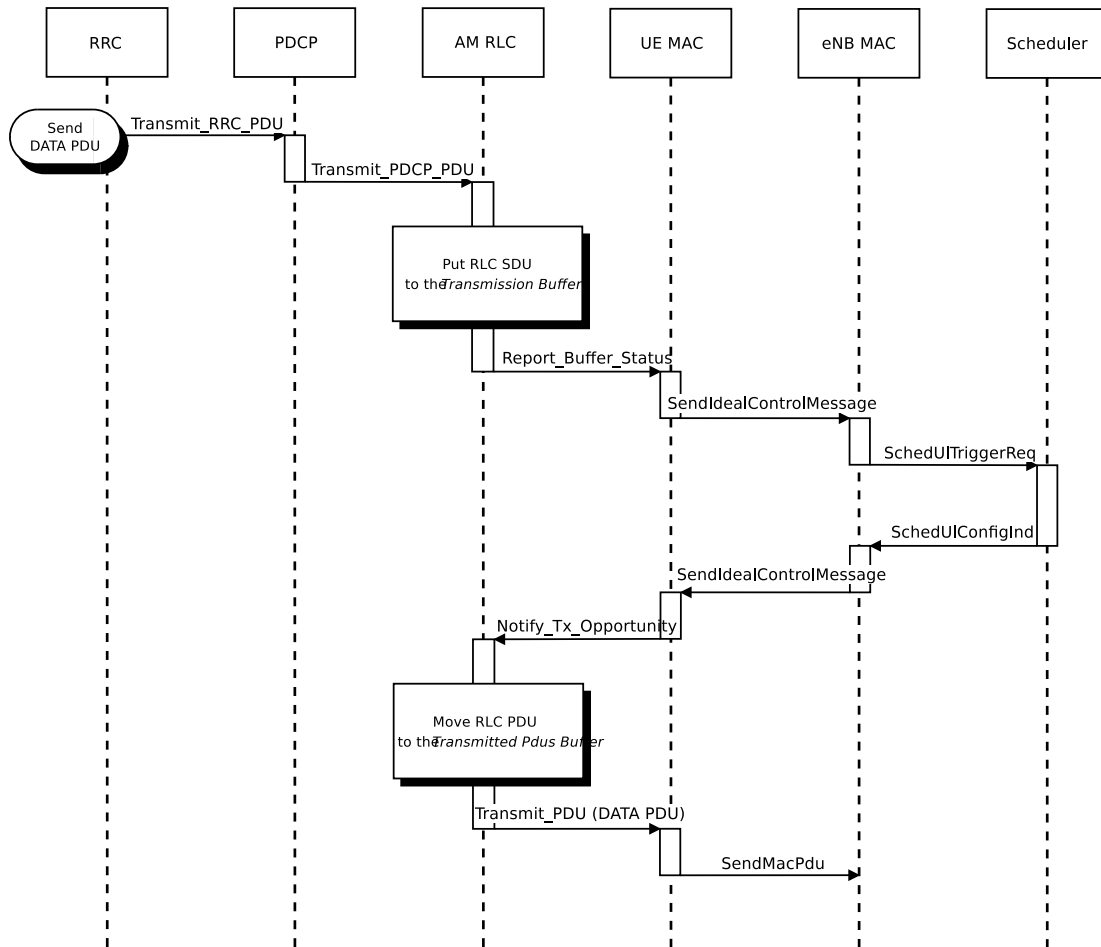

Fig. 28: Sequence diagram of data PDU transmission in uplink

It is similar to the sequence diagram in downlink; the main difference is that in this case the Report\_Buffer\_Status is sent from the UE MAC to the MAC Scheduler in the eNB over the air using the control channel.

### Retransmission in uplink

The sequence diagram of Figure *Sequence diagram of data PDU retransmission in uplink* shows the interactions between the different entities of the UE (AM RLC and MAC) and the eNB (MAC) in uplink when data PDUs must be retransmitted by the AM RLC entity.

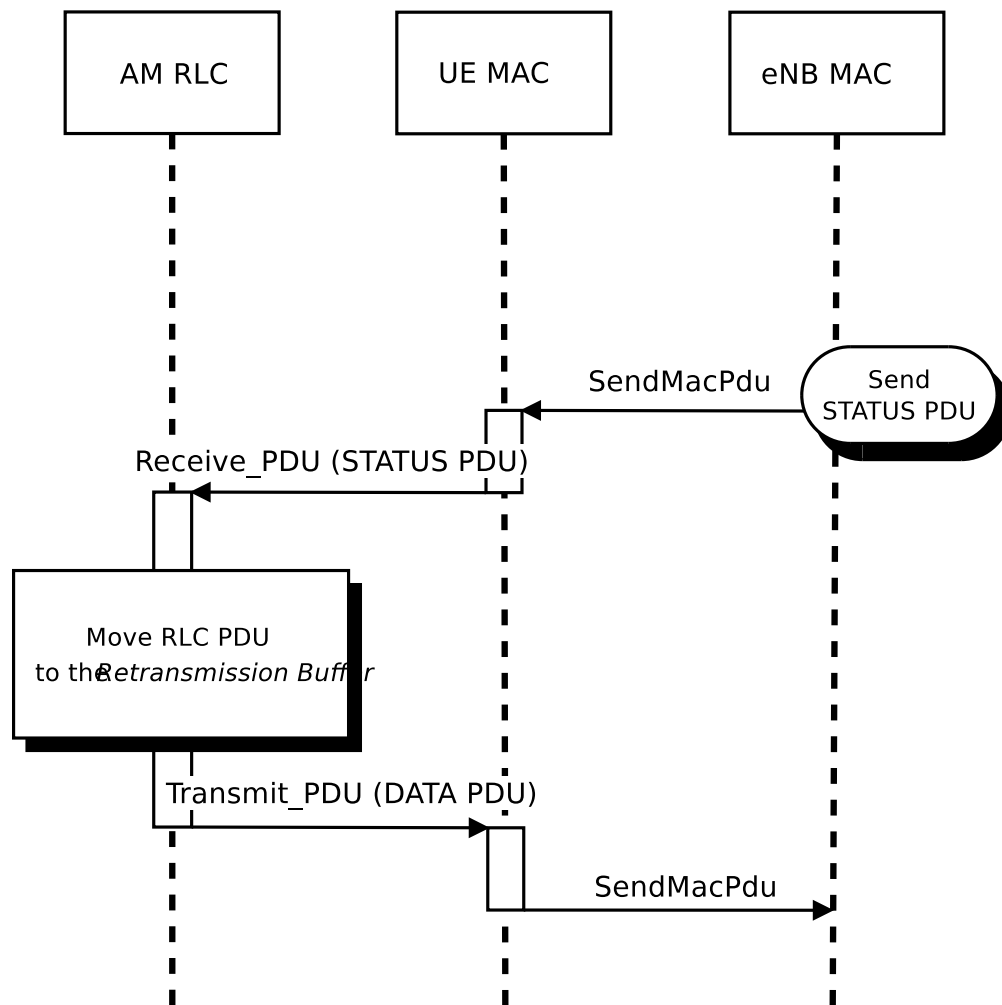

Fig. 29: Sequence diagram of data PDU retransmission in uplink

### Calculation of the buffer size

The Transmission Buffer contains RLC SDUs. A RLC PDU is one or more SDU segments plus an RLC header. The size of the RLC header of one RLC PDU depends on the number of SDU segments the PDU contains.

The 3GPP standard (section 6.1.3.1 of [TS36321]) says clearly that, for the uplink, the RLC and MAC headers are not considered in the buffer size that is to be report as part of the Buffer Status Report. For the downlink, the behavior is not specified. Neither [FFAPI] specifies how to do it. Our RLC model works by assuming that the calculation of the buffer size in the downlink is done exactly as in the uplink, i.e., not considering the RLC and MAC header size.

We note that this choice affects the interoperation with the MAC scheduler, since, in response to the `Notify_Tx_Opportunity` service primitive, the RLC is expected to create a PDU of no more than the size requested by the MAC, including RLC overhead. Hence, unneeded fragmentation can occur if (for example) the MAC notifies a transmission exactly equal to the buffer size previously reported by the RLC. We assume that it is left to the Scheduler to implement smart strategies for the selection of the size of the transmission opportunity, in order to eventually avoid the inefficiency of unneeded fragmentation.

## Concatenation and Segmentation

The AM RLC entity generates and sends exactly one RLC PDU for each transmission opportunity even if it is smaller than the size reported by the transmission opportunity. So for instance, if a STATUS PDU is to be sent, then only this PDU will be sent in that transmission opportunity.

The segmentation and concatenation for the SDU queue of the AM RLC entity follows the same philosophy as the same procedures of the UM RLC entity but there are new state variables (see [TS36322] section 7.1) only present in the AM RLC entity.

It is noted that, according to the 3GPP specs, there is no concatenation for the Retransmission Buffer.

## Re-segmentation

The current model of the AM RLC entity does not support the re-segmentation of the retransmission buffer. Rather, the AM RLC entity just waits to receive a big enough transmission opportunity.

## Unsupported features

We do not support the following procedures of [TS36322] :

- “Send an indication of successful delivery of RLC SDU” (See section 5.1.3.1.1)
- “Indicate to upper layers that max retransmission has been reached” (See section 5.2.1)
- “SDU discard procedures” (See section 5.3)
- “Re-establishment procedure” (See section 5.4)

We do not support any of the additional primitives of RLC SAP for AM RLC entity. In particular:

- no SDU discard notified by PDCP
- no notification of successful / failed delivery by AM RLC entity to PDCP entity

## UM RLC

In this section we describe the implementation of the Unacknowledged Mode (UM) RLC entity.

### Transmit operations in downlink

The transmit operations of the UM RLC are similar to those of the AM RLC previously described in Section *Transmit operations in downlink*, with the difference that, following the specifications of [TS36322], retransmission are not performed, and there are no STATUS PDUs.

## Transmit operations in uplink

The transmit operations in the uplink are similar to those of the downlink, with the main difference that the `Report_Buffer_Status` is sent from the UE MAC to the MAC Scheduler in the eNB over the air using the control channel.

## Calculation of the buffer size

The calculation of the buffer size for the UM RLC is done using the same approach of the AM RLC, please refer to section *Calculation of the buffer size* for the corresponding description.

## TM RLC

In this section we describe the implementation of the Transparent Mode (TM) RLC entity.

## Transmit operations in downlink

In the simulator, the TM RLC still provides to the upper layers the same service interface provided by the AM and UM RLC entities to the PDCP layer; in practice, this interface is used by an RRC entity (not a PDCP entity) for the transmission of RLC SDUs. This choice is motivated by the fact that the services provided by the TM RLC to the upper layers, according to [TS36322], is a subset of those provided by the UM and AM RLC entities to the PDCP layer; hence, we reused the same interface for simplicity.

The transmit operations in the downlink are performed as follows. When the `Transmit_PDCP_PDU` service primitive is called by the upper layers, the TM RLC does the following:

- put the SDU in the Transmission Buffer
- compute the size of the Transmission Buffer
- call the `Report_Buffer_Status` service primitive of the eNB MAC entity

Afterwards, when the MAC scheduler decides that some data can be sent by the logical channel to which the TM RLC entity belongs, the MAC entity notifies it to the TM RLC entity by calling the `Notify_Tx_Opportunity` service primitive. Upon reception of this primitive, the TM RLC entity does the following:

- if the TX opportunity has a size that is greater than or equal to the size of the head-of-line SDU in the Transmission Buffer
  - dequeue the head-of-line SDU from the Transmission Buffer
  - create one RLC PDU that contains entirely that SDU, without any RLC header
  - Call the `Transmit_PDU` primitive in order to send the RLC PDU to the MAC entity.

## Transmit operations in uplink

The transmit operations in the uplink are similar to those of the downlink, with the main difference that a transmission opportunity can also arise from the assignment of the UL GRANT as part of the Random Access procedure, without an explicit Buffer Status Report issued by the TM RLC entity.



## Calculation of the buffer size

As per the specifications [TS36322], the TM RLC does not add any RLC header to the PDUs being transmitted. Because of this, the buffer size reported to the MAC layer is calculated simply by summing the size of all packets in the transmission buffer, thus notifying to the MAC the exact buffer size.

## SM RLC

In addition to the AM, UM and TM implementations that are modeled after the 3GPP specifications, a simplified RLC model is provided, which is called Saturation Mode (SM) RLC. This RLC model does not accept PDUs from any above layer (such as PDCP); rather, the SM RLC takes care of the generation of RLC PDUs in response to the notification of transmission opportunities notified by the MAC. In other words, the SM RLC simulates saturation conditions, i.e., it assumes that the RLC buffer is always full and can generate a new PDU whenever notified by the scheduler.

The SM RLC is used for simplified simulation scenarios in which only the LTE Radio model is used, without the EPC and hence without any IP networking support. We note that, although the SM RLC is an unrealistic traffic model, it still allows for the correct simulation of scenarios with multiple flows belonging to different (non real-time) QoS classes, in order to test the QoS performance obtained by different schedulers. This can be done since it is the task of the Scheduler to assign transmission resources based on the characteristics (e.g., Guaranteed Bit Rate) of each Radio Bearer, which are specified upon the definition of each Bearer within the simulation program.

As for schedulers designed to work with real-time QoS traffic that has delay constraints, the SM RLC is probably not an appropriate choice. This is because the absence of actual RLC SDUs (replaced by the artificial generation of Buffer Status Reports) makes it not possible to provide the Scheduler with meaningful head-of-line-delay information, which is often the metric of choice for the implementation of scheduling policies for real-time traffic flows. For the simulation and testing of such schedulers, it is advisable to use either the UM or the AM RLC models instead.

## 19.1.9 PDCP

### PDCP Model Overview

The reference document for the specification of the PDCP entity is [TS36323]. With respect to this specification, the PDCP model implemented in the simulator supports only the following features:

- transfer of data (user plane or control plane);
- maintenance of PDCP SNs;
- transfer of SN status (for use upon handover);

The following features are currently not supported:

- header compression and decompression of IP data flows using the ROHC protocol;
- in-sequence delivery of upper layer PDUs at re-establishment of lower layers;
- duplicate elimination of lower layer SDUs at re-establishment of lower layers for radio bearers mapped on RLC AM;
- ciphering and deciphering of user plane data and control plane data;
- integrity protection and integrity verification of control plane data;
- timer based discard;
- duplicate discarding.

## PDCP Service Interface

The PDCP service interface is divided into two parts:

- the `PdcpSapProvider` part is provided by the PDCP layer and used by the upper layer and
- the `PdcpSapUser` part is provided by the upper layer and used by the PDCP layer.

## PDCP Service Primitives

The following list specifies which service primitives are provided by the PDCP service interfaces:

- `PdcpSapProvider::TransmitPdcpsdu`
  - The RRC entity uses this primitive to send an RRC PDU to the lower PDCP entity in the transmitter peer
- `PdcpSapUser::ReceivePdcpsdu`
  - The PDCP entity uses this primitive to send an RRC PDU to the upper RRC entity in the receiver peer

## 19.1.10 RRC

### Features

The RRC model implemented in the simulator provides the following functionality:

- generation (at the eNB) and interpretation (at the UE) of System Information (in particular the Master Information Block and, at the time of this writing, only System Information Block Type 1 and 2)
- initial cell selection
- RRC connection establishment procedure
- RRC reconfiguration procedure, supporting the following use cases: + reconfiguration of the SRS configuration index + reconfiguration of the PHY TX mode (MIMO) + reconfiguration of UE measurements + data radio bearer setup + handover
- RRC connection re-establishment, supporting the following use cases: + handover

### Architecture

The RRC model is divided into the following components:

- the RRC entities *LteUeRrc* and *LteEnbRrc*, which implement the state machines of the RRC entities respectively at the UE and the eNB;
- the RRC SAPs *LteUeRrcSapProvider*, *LteUeRrcSapUser*, *LteEnbRrcSapProvider*, *LteEnbRrcSapUser*, which allow the RRC entities to send and receive RRC messages and information elements;
- the RRC protocol classes *LteUeRrcProtocolIdeal*, *LteEnbRrcProtocolIdeal*, *LteUeRrcProtocolReal*, *LteEnbRrcProtocolReal*, which implement two different models for the transmission of RRC messages.

Additionally, the RRC components use various other SAPs in order to interact with the rest of the protocol stack. A representation of all the SAPs that are used is provided in the figures *LTE radio protocol stack architecture for the UE on the data plane*, *LTE radio protocol stack architecture for the UE on the control plane*, *LTE radio protocol stack architecture for the eNB on the data plane* and *LTE radio protocol stack architecture for the eNB on the control plane*.

### UE RRC State Machine

In Figure *UE RRC State Machine* we represent the state machine as implemented in the RRC UE entity.

All the states are transient, however, the UE in “CONNECTED\_NORMALLY” state will only switch to the IDLE state if the downlink SINR is below a defined threshold, which would lead to radio link failure *Radio Link Failure*. On the other hand, the UE would not be able to switch to IDLE mode due to a handover failure, as mentioned in *X2*.

### ENB RRC State Machine

The eNB RRC maintains the state for each UE that is attached to the cell. From an implementation point of view, the state of each UE is contained in an instance of the *UeManager* class. The state machine is represented in Figure *ENB RRC State Machine for each UE*.

### Initial Cell Selection

Initial cell selection is an IDLE mode procedure, performed by UE when it has not yet camped or attached to an eNodeB. The objective of the procedure is to find a suitable cell and attach to it to gain access to the cellular network.

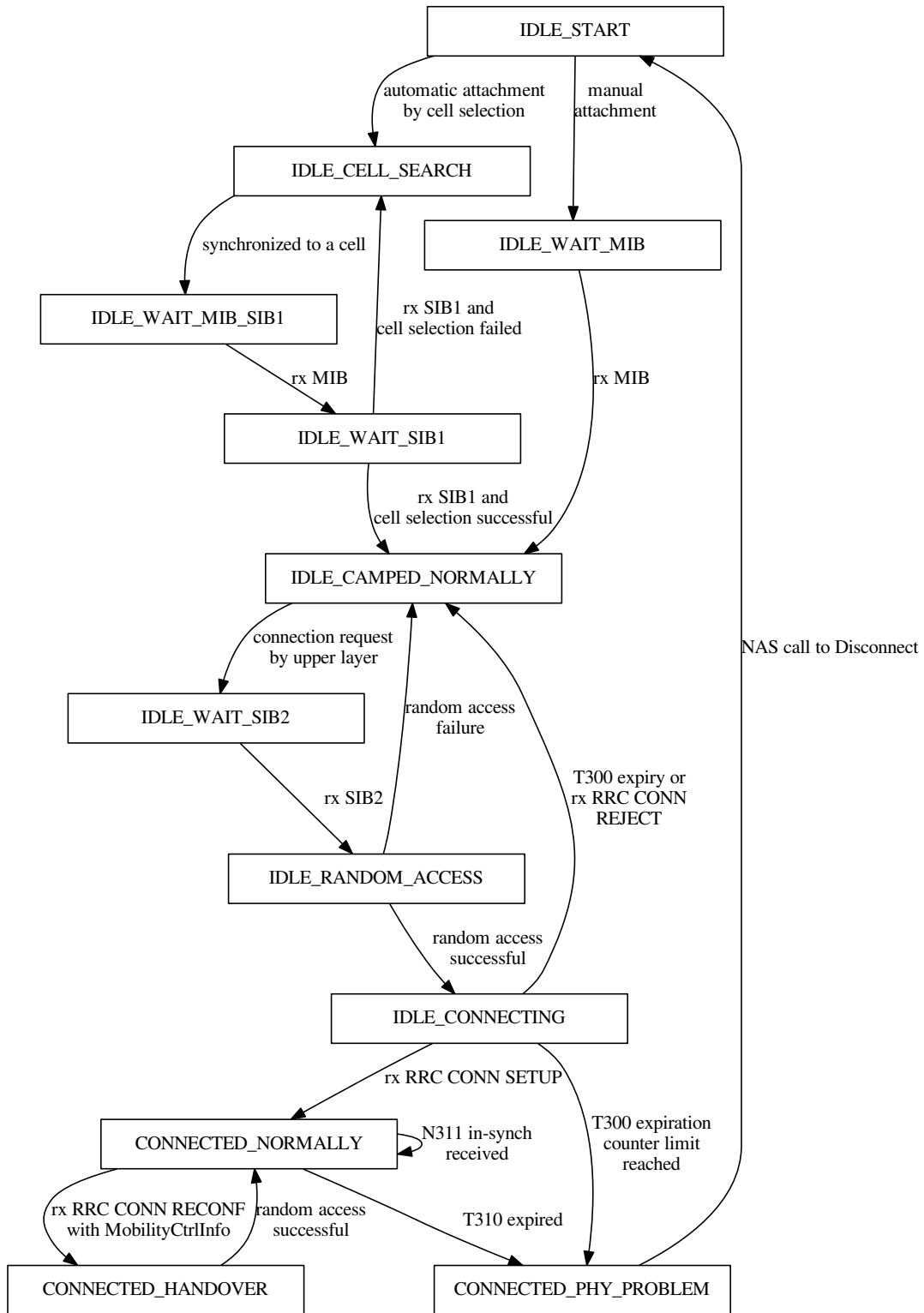

Fig. 30: UE RRC State Machine

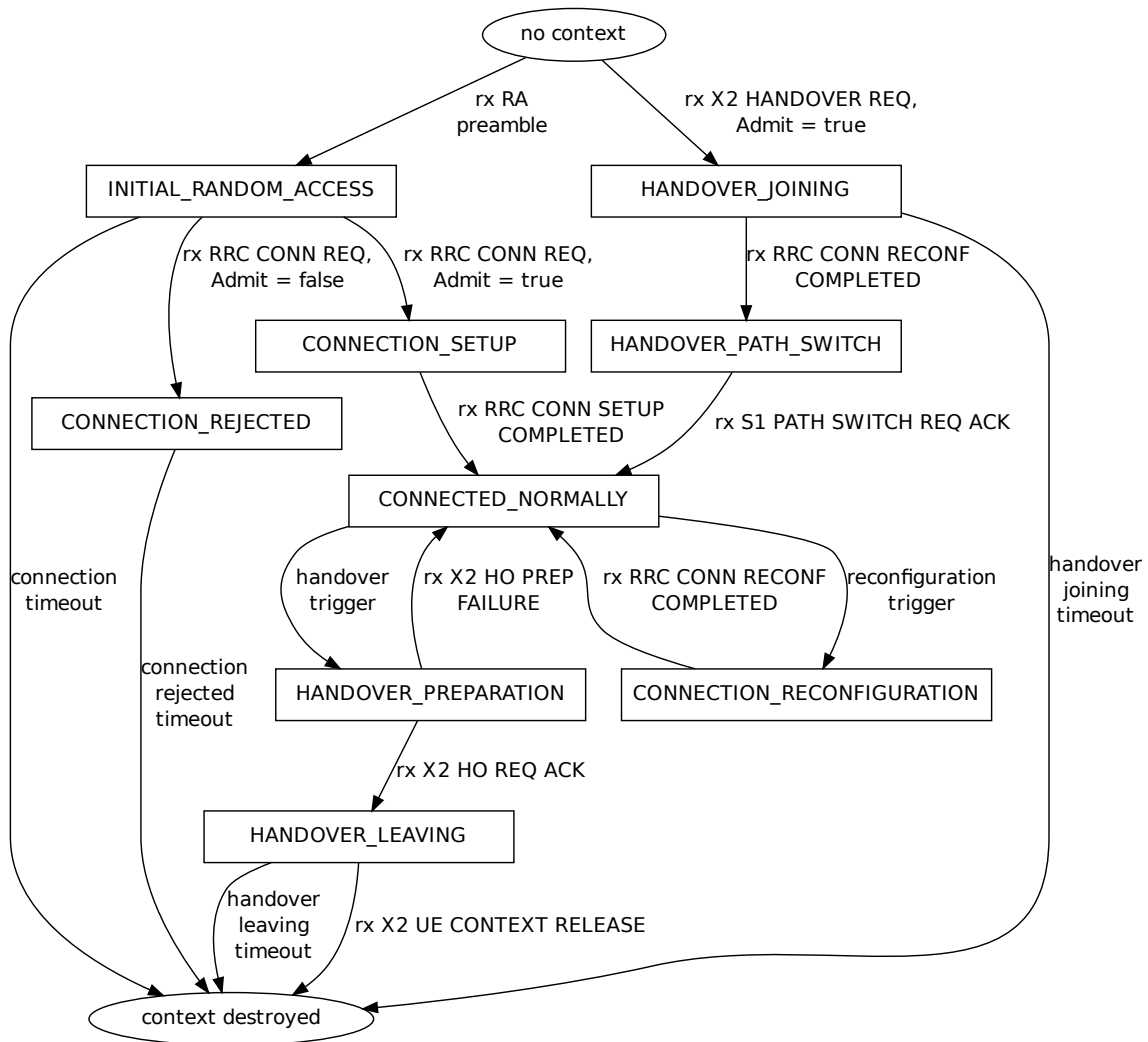

Fig. 31: ENB RRC State Machine for each UE

It is typically done at the beginning of simulation, as depicted in Figure *Sample runs of initial cell selection in UE and timing of related events* below. The time diagram on the left side is illustrating the case where initial cell selection succeed on first try, while the diagram on the right side is for the case where it fails on the first try and succeed on the second try. The timing assumes the use of real RRC protocol model (see *RRC protocol models*) and no transmission error.

The functionality is based on 3GPP IDLE mode specifications, such as in [TS36300], [TS36304], and [TS36331]. However, a proper implementation of IDLE mode is still missing in the simulator, so we reserve several simplifying assumptions:

- multiple carrier frequency is not supported;
- multiple Public Land Mobile Network (PLMN) identities (i.e. multiple network operators) is not supported;
- RSRQ measurements are not utilized;
- stored information cell selection is not supported;
- “Any Cell Selection” state and camping to an acceptable cell is not supported;
- marking a cell as barred or reserved is not supported;
- Idle cell reselection is not supported, hence it is not possible for UE to camp to a different cell after the initial camp has been placed; and
- UE’s Closed Subscriber Group (CSG) white list contains only one CSG identity.

Also note that initial cell selection is only available for EPC-enabled simulations. LTE-only simulations must use the manual attachment method. See section *Network Attachment* of the User Documentation for more information on their differences in usage.

The next subsections cover different parts of initial cell selection, namely *cell search*, *broadcast of system information*, and *cell selection evaluation*.

### Cell Search

Cell search aims to detect surrounding cells and measure the strength of received signal from each of these cells. One of these cells will become the UE’s entry point to join the cellular network.

The measurements are based on the RSRP of the received PSS, averaged by Layer 1 filtering, and performed by the PHY layer, as previously described in more detail in section *UE PHY Measurements Model*. PSS is transmitted by eNodeB over the central 72 sub-carriers of the DL channel (Section 5.1.7.3 [TS36300]), hence we model cell search to operate using a DL bandwidth of 6 RBs. Note that measurements of RSRQ are not available at this point of time in simulation. As a consequence, the `LteUEPhy::RsrqUeMeasThreshold` attribute does not apply during cell search.

By using the measured RSRP, the PHY entity is able to generate a list of detected cells, each with its corresponding cell ID and averaged RSRP. This list is periodically pushed via CPHY SAP to the RRC entity as a measurement report.

The RRC entity inspects the report and simply choose the cell with the strongest RSRP, as also indicated in Section 5.2.3.1 of [TS36304]. Then it instructs back the PHY entity to synchronize to this particular cell. The actual operating bandwidth of the cell is still unknown at this time, so the PHY entity listens only to the minimum bandwidth of 6 RBs. Nevertheless, the PHY entity will be able to receive system broadcast message from this particular eNodeB, which is the topic of the next subsection.

### Broadcast of System Information

System information blocks are broadcasted by eNodeB to UEs at predefined time intervals, adapted from Section 5.2.1.2 of [TS36331]. The supported system information blocks are:

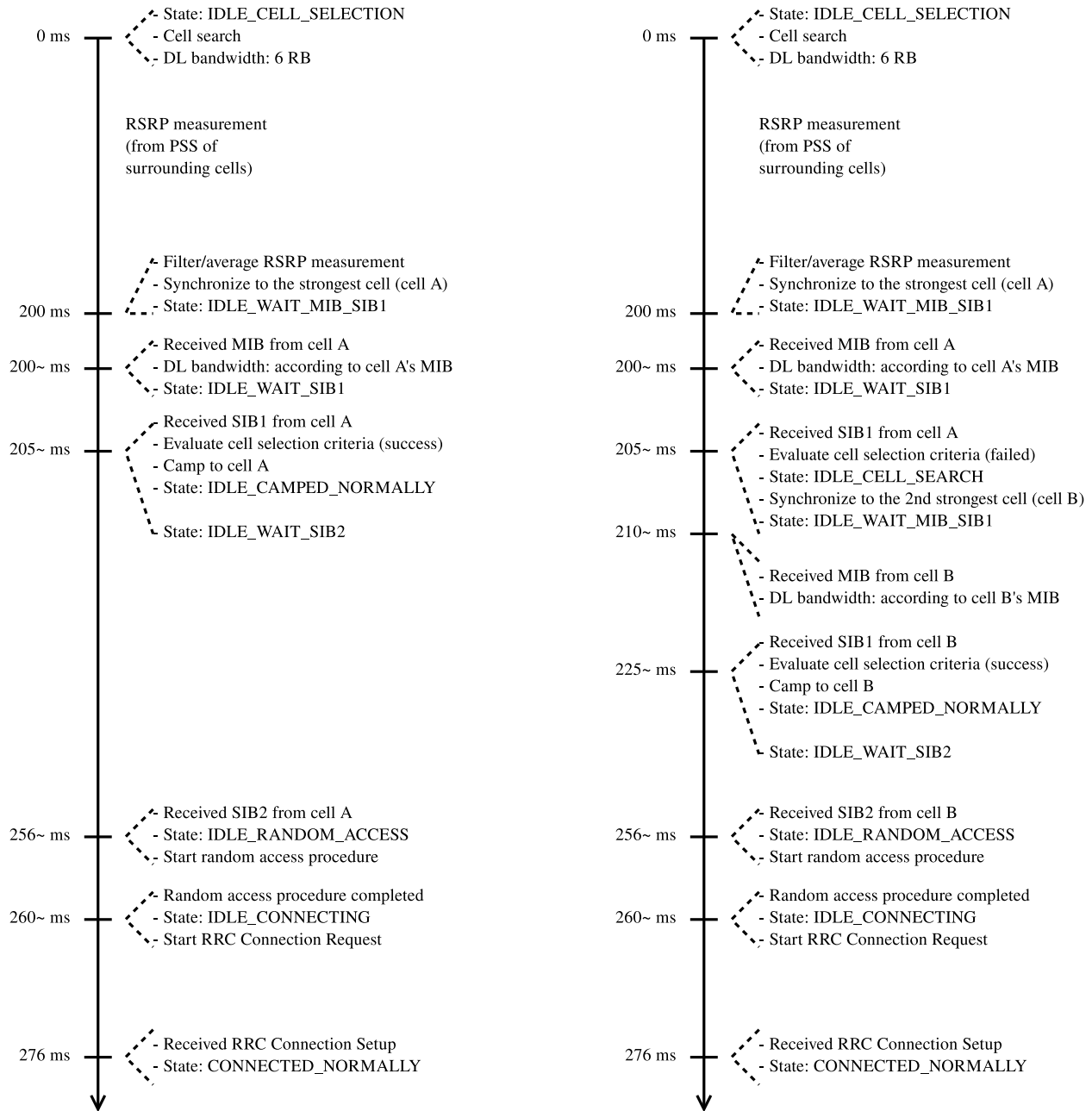

Fig. 32: Sample runs of initial cell selection in UE and timing of related events

- **Master Information Block (MIB)** Contains parameters related to the PHY layer, generated during cell configuration and broadcasted every 10 ms at the beginning of radio frame as a control message.
- **System Information Block Type 1 (SIB1)** Contains information regarding network access, broadcasted every 20 ms at the middle of radio frame as a control message. Not used in manual attachment method. UE must have decoded MIB before it can receive SIB1.
- **System Information Block Type 2 (SIB2)** Contains UL- and RACH-related settings, scheduled to transmit via RRC protocol at 16 ms after cell configuration, and then repeats every 80 ms (configurable through *LteEnbRrc::SystemInformationPeriodicity* attribute). UE must be camped to a cell in order to be able to receive its SIB2.

Reception of system information is fundamental for UE to advance in its lifecycle. MIB enables the UE to increase the initial DL bandwidth of 6 RBs to the actual operating bandwidth of the network. SIB1 provides information necessary for cell selection evaluation (explained in the next section). And finally SIB2 is required before the UE is allowed to switch to CONNECTED state.

## Cell Selection Evaluation

UE RRC reviews the measurement report produced in *Cell Search* and the cell access information provided by SIB1. Once both information is available for a specific cell, the UE triggers the evaluation process. The purpose of this process is to determine whether the cell is a suitable cell to camp to.

The evaluation process is a slightly simplified version of Section 5.2.3.2 of [TS36304]. It consists of the following criteria:

- Rx level criterion; and
- closed subscriber group (CSG) criterion.

The first criterion, Rx level, is based on the cell's measured RSRP  $Q_{rxlevmeas}$ , which has to be higher than a required minimum  $Q_{rxlevmin}$  in order to pass the criterion:

$$Q_{rxlevmeas} - Q_{rxlevmin} > 0$$

where  $Q_{rxlevmin}$  is determined by each eNodeB and is obtainable by UE from SIB1.

The last criterion, CSG, is a combination of a true-or-false parameter called *CSG indication* and a simple number *CSG identity*. The basic rule is that UE shall not camp to eNodeB with a different CSG identity. But this rule is only enforced when CSG indication is valued as true. More details are provided in Section *Network Attachment* of the User Documentation.

When the cell passes all the above criteria, the cell is deemed as *suitable*. Then UE camps to it (*IDLE\_CAMPED\_NORMALLY* state).

After this, upper layer may request UE to enter CONNECTED mode. Please refer to section *RRC connection establishment* for details on this.

On the other hand, when the cell does not pass the CSG criterion, then the cell is labeled as *acceptable* (Section 10.1.1.1 [TS36300]). In this case, the RRC entity will tell the PHY entity to synchronize to the second strongest cell and repeat the initial cell selection procedure using that cell. As long as no suitable cell is found, the UE will repeat these steps while avoiding cells that have been identified as acceptable.

## Radio Admission Control

Radio Admission Control is supported by having the eNB RRC reply to an RRC CONNECTION REQUEST message sent by the UE with either an RRC CONNECTION SETUP message or an RRC CONNECTION REJECT message,



depending on whether the new UE is to be admitted or not. In the current implementation, the behavior is determined by the boolean attribute `ns3::LteEnbRrc::AdmitRrcConnectionRequest`. There is currently no Radio Admission Control algorithm that dynamically decides whether a new connection shall be admitted or not.

## Radio Bearer Configuration

Some implementation choices have been made in the RRC regarding the setup of radio bearers:

- three Logical Channel Groups (out of four available) are configured for uplink buffer status report purposes, according to the following policy:
  - LCG 0 is for signaling radio bearers
  - LCG 1 is for GBR data radio bearers
  - LCG 2 is for Non-GBR data radio bearers

## Radio Link Failure

In real LTE networks, Radio link failure (RLF) can happen due to several reasons. It can be triggered if a UE is unable to decode PDCCH due to poor signal quality, upon maximum RLC retransmissions, RACH problems and other reasons. 3GPP only specifies guidelines to detect RLF at the UE side, in [TS36331] and [TS36133]. On the other hand, the eNB implementation is expected to be vendor specific. To implement the RLF functionality in ns-3, we have assumed the following simplifications:

- The RLF detection procedure at eNodeB is not implemented. **Instead, a direct function call by using the SAP between UE and eNB RRC (for both ideal and real RRC) is used to notify the eNB about the RLF.**
- No RRC connection re-establishment procedure is implemented, thus, the UE directly goes to the IDLE state upon RLF. This is in fact as per the standard [TS36331] sec 5.3.11.3, since, at this stage the LTE module does not support the Access Stratum (AS) security.

The above mentioned RLF specifications can be divided into the following two categories:

1. RLF detection
2. Actions upon RLF detection

In the following, we will explain the RLF implementation in context of these two categories.

### RLF detection implementation

The RLF detection at the UE is implemented as per [TS36133], i.e., by monitoring the radio link quality based on the reference signals (which in the simulation is equivalent to the PDCCH) in the downlink. Thus, it is independent of the method used for the downlink CQI computation, i.e., *Ctrl* method and *Mixed method*. Moreover, when using FFR, especially for hard-FFR, and CQIs based on *Mixed method*, UEs might experience relatively good performance and RLF simultaneously. This is due to the fact that the interference in PDSCH is affected by the actual data transmissions on the specific RBs and the power control. Therefore, UEs might experience good SINR in PDSCH, while bad SINR in PDCCH channel. For more details about these methods please refer to *CQI feedback*. Also, it does not matter if the DL control error model is disabled, a UE can still detect the RLF since the SINR based on the control channel is reported to the `LteUePhy` class, using a callback hooked in `LteHelper` while installing a UE device.

The RLF detection starts once the RRC connection is established between UE and eNodeB, i.e., UE is in “CONNECTED\_NORMALLY” state; upon which the RLF parameters are configured (see `LteUePhy::DoConfigureRadioLinkFailureDetection`). In real networks, these parameters are transmitted

by the eNB using IE UE-TimersAndConstants or RLF-TimersAndConstants. However, for the sake of simplification, in the simulator they are presented as the attributes of the `LteUePhy` and `LteUeRrc` classes. Moreover, what concerns the carrier aggregation, i.e., when a UE is configured with multiple component carriers, the RLF detection is only performed by the primary component carrier, i.e. component carrier id 0 (see `LteUePhy::DoNotifyConnectionSuccessful`). In `LteUePhy` class, CQI calculation is triggered for every downlink subframe received, and the average SINR value is measured across all resource blocks. For the RLF detection, these SINR values are averaged over a downlink frame and if the result is less than a defined threshold `Qout` (default: -5dB), the frame cannot be decoded (see ‘`LteUePhy::RadioLinkFailureDetection`‘). The `Qout` threshold corresponds to 10% block error rate (BLER) of a hypothetical PDCCH transmission taking into account the PCFICH errors [R4-081920] (also refer to *Control Channels PHY Error Model*). Once, the UE is unable to decode 20 consecutive frames, i.e., the `Qout` evaluation period (200ms) is reached, an out-of-sync indication is sent to the UE RRC layer (see `LteUeRrc::DoNotifyOutOfSync`). Else, the counter for the unsuccessfully decoded frames is reset to zero. At the `LteUeRrc`, when the number of consecutive out-of-sync indications matches with the value of `N310` parameter, the `T310` timer is started and `LteUePhy` is notified to start measuring for in-sync indications (see `LteUePhy::DoStartInSyncDetection`). We note that, the UE RRC state is not changed till the expiration of `T310` timer. If the resultant SINR values averaged over a downlink frame is greater than a defined threshold `Qin` (default: -3.8dB), the frame is considered to be successfully decoded. `Qin` corresponds to 2% BLER [R4-081920] of a hypothetical PDCCH transmission taking into account the PCFICH errors. Once the UE is able to decode 10 consecutive frames, an in-sync indication is sent to the UE RRC layer (see `LteUeRrc::DoNotifyInSync`). Else, the counter for the successfully decoded frames is reset to zero. If prior to the `T310` timer expiry, the number of consecutive in-sync indications matches with `N311` parameter of `LteUeRRC`, the UE is considered back in-sync. At this stage, the related parameters are reset to initiate the radio link failure detection from the beginning (see `LteUePhy::DoConfigureRadioLinkFailureDetection`). On the other hand, If the `T310` timer expires, the UE considers that a RLF has occurred (see `LteUeRrc::RadioLinkFailureDetected`).

## Actions upon RLF

Once the `T310` timer is expired, a UE is considered to be in RLF; upon which the UE RRC:

- Sends a request to the eNB RRC to remove the UE context
- Moves to “CONNECTED\_PHY\_PROBLEM” state
- Notifies the UE NAS layer about the release of RRC connection.

Then, after getting the notification from the UE RRC the NAS does the following:

- Delete all the TFTs
- Reset the bearer counter
- Restore the bearer list, which is used to activate the bearers for the next RRC connection. This restoration of the bearers is achieved by maintaining an additional list, i.e., `m_bearersToBeActivatedListForReconnection` in `EpcUeNas` class
- Switch the NAS state to OFF by calling `EpcUeNas::Disconnect`
- Tells the UE RRC to disconnect

The UE RRC, upon receiving the call to disconnect from the `EpcUeNas` class, performs the action as specified by [TS36331] 5.3.11.3, and finally leaves the connected state, i.e., its RRC state is changed from “CONNECTED\_PHY\_PROBLEM” to “IDLE\_START” to perform cell selection as shown in figures *UE RRC State Machine* and *UE procedures after radio link failure*.

At this stage, the LTE module does not support the paging functionality, therefore, to allow a UE to read SIB2 message after camping on a suitable cell after RLF, a work around is used in `LteUeRrc::EvaluateCellForSelection` method. As per this workaround, the UE RRC invokes the call to `LteUeRrc::DoConnect` method, which enables

the UE to switch its state from “IDLE\_CAMPED\_NORMALLY” to “IDLE\_WAIT\_SIB2”, thus, allowing it to perform the random access.

The eNB RRC, after receiving the notification from the UE RRC starts the procedure of UE context deletion, which also involves the deletion of the UE context removal from the EPC *UE context removal from EPC* and the eNB stack *UE context removal from eNB stack*. We note that, the UE context at the MME is not removed since, bearers are only added at the start of a simulation in MME, and cannot be added again unless scheduled for addition during a simulation.

## UE RRC Measurements Model

### UE RRC measurements support

The UE RRC entity provides support for UE measurements; in particular, it implements the procedures described in Section 5.5 of [TS36331], with the following simplifying assumptions:

- only E-UTRA intra-frequency measurements are supported, which implies:
  - only one measurement object is used during the simulation;
  - measurement gaps are not needed to perform the measurements;
  - Event B1 and B2 are not implemented;
- only *reportStrongestCells* purpose is supported, while *reportCGI* and *reportStrongestCellsForSON* purposes are not supported;
- *s-Measure* is not supported;
- carrier aggregation is now supported in the LTE module - Event A6 is not implemented;
- speed dependent scaling of time-to-trigger (Section 5.5.6.2 of [TS36331]) is not supported.

### Overall design

The model is based on the concept of *UE measurements consumer*, which is an entity that may request an eNodeB RRC entity to provide UE measurement reports. Consumers are, for example, *Handover algorithm*, which compute handover decision based on UE measurement reports. Test cases and user’s programs may also become consumers. Figure *Relationship between UE measurements and its consumers* depicts the relationship between these entities.

The whole UE measurements function at the RRC level is divided into 4 major parts:

1. Measurement configuration (handled by `LteUeRrc::ApplyMeasConfig`)
2. Performing measurements (handled by `LteUeRrc::DoReportUeMeasurements`)
3. Measurement report triggering (handled by `LteUeRrc::MeasurementReportTriggering`)
4. Measurement reporting (handled by `LteUeRrc::SendMeasurementReport`)

The following sections will describe each of the parts above.

### Measurement configuration

An eNodeB RRC entity configures UE measurements by sending the configuration parameters to the UE RRC entity. This set of parameters are defined within the `MeasConfig` Information Element (IE) of the RRC Connection Reconfiguration message (*RRC connection reconfiguration*).

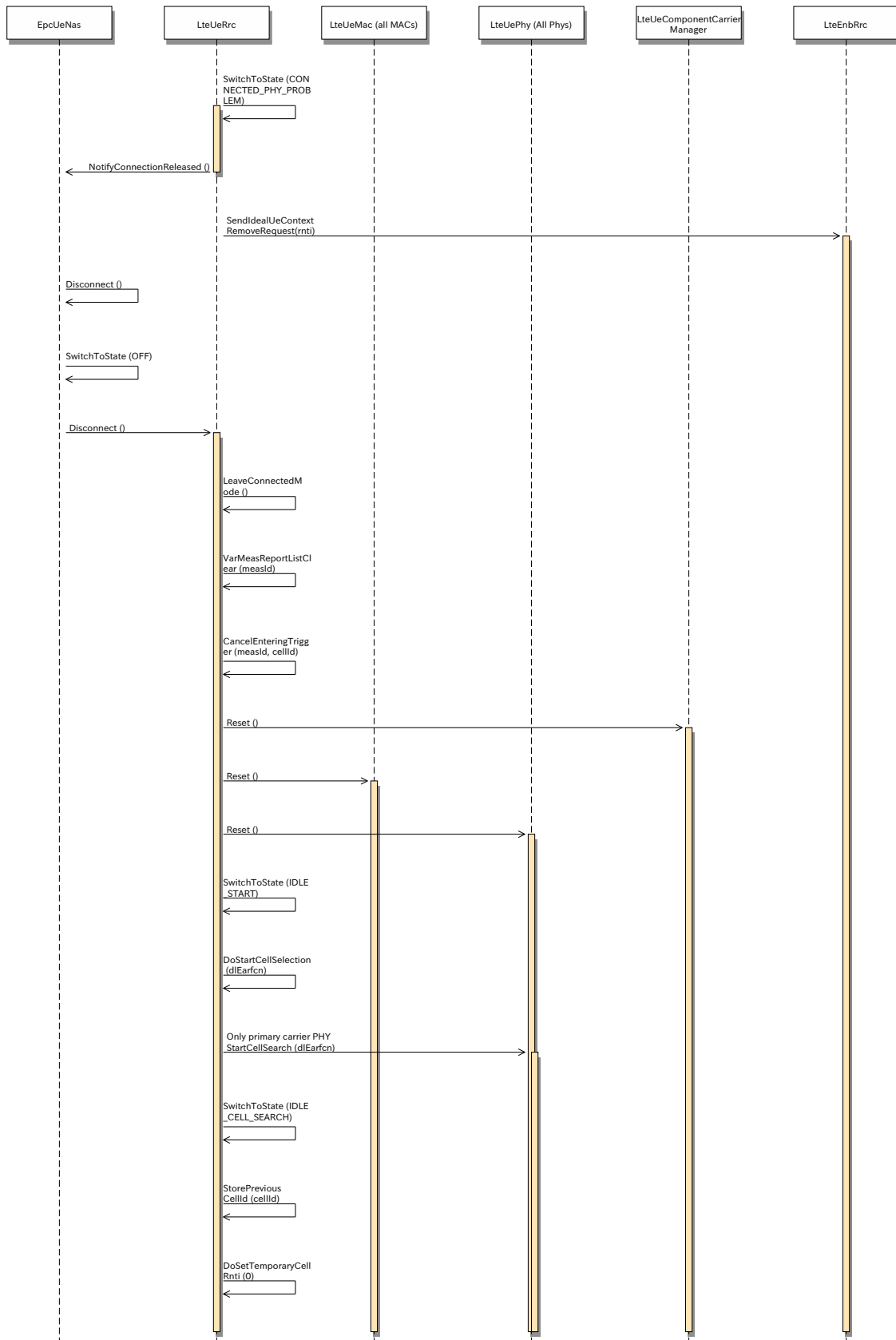

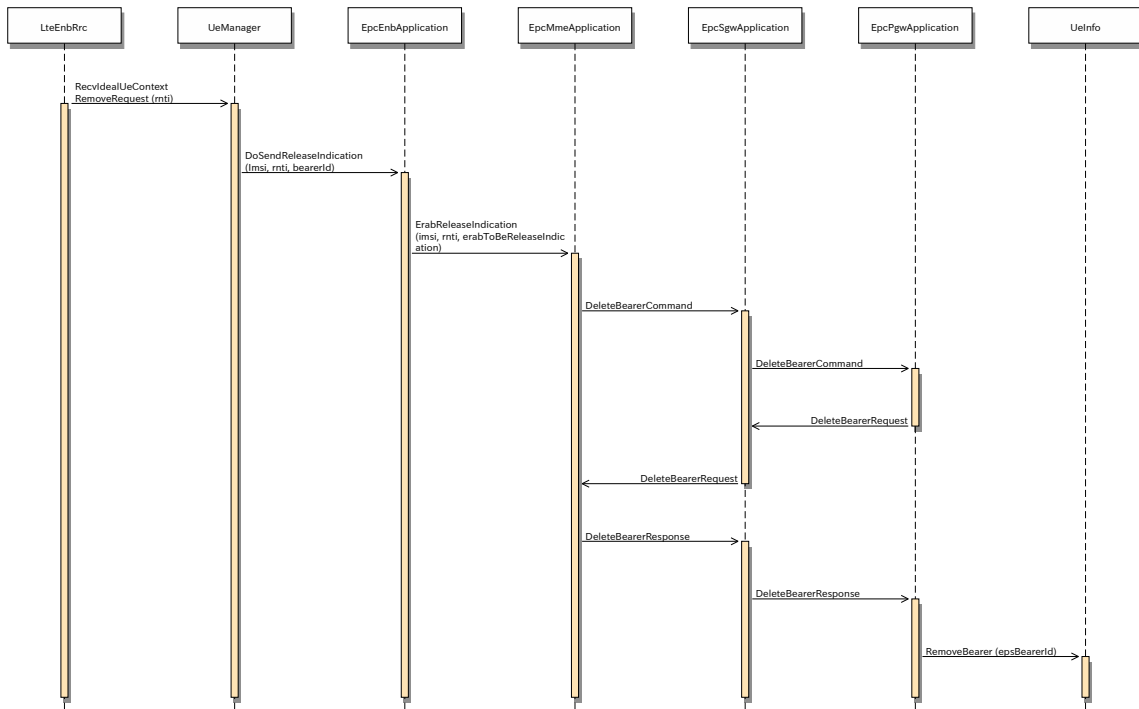

Fig. 34: UE context removal from EPC

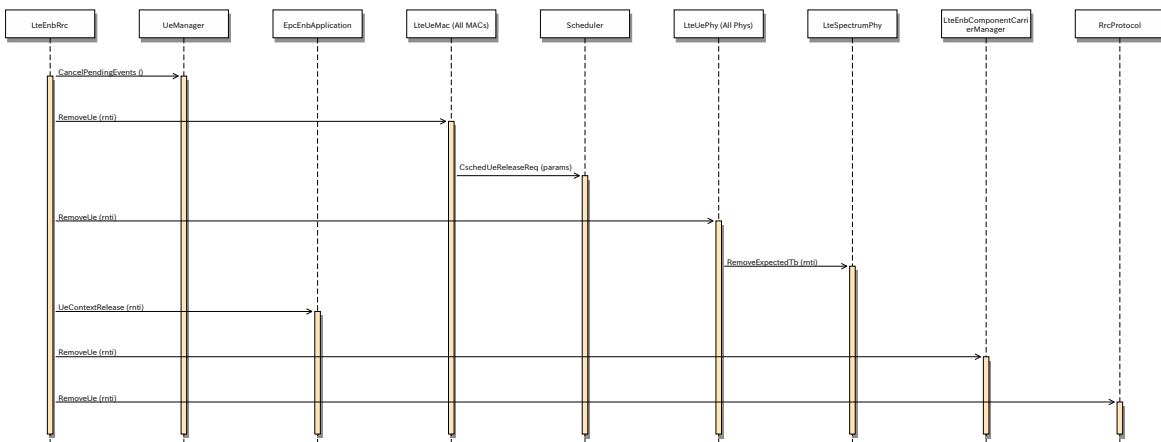

Fig. 35: UE context removal from eNB stack

**UE Measurements Consumers**

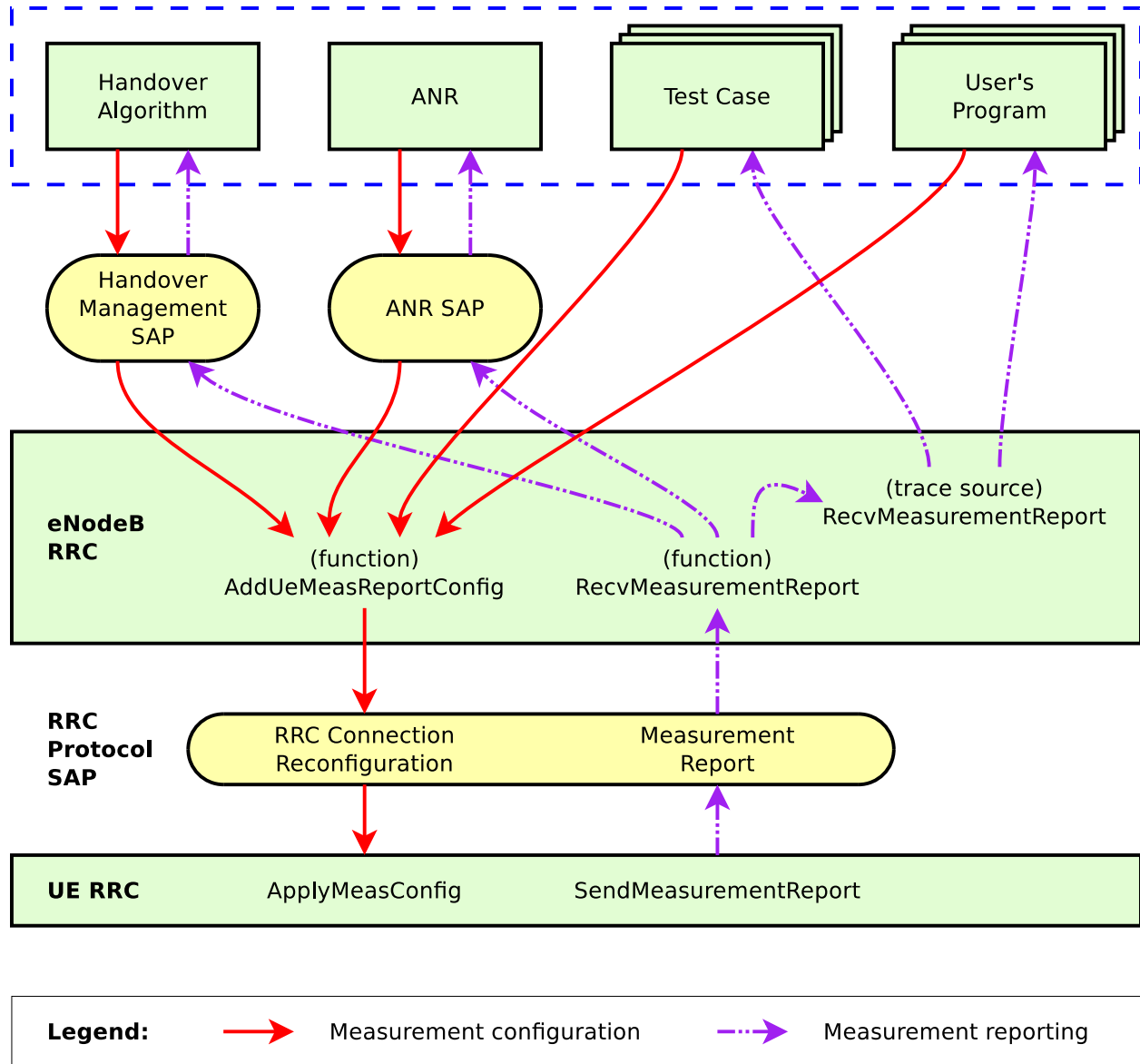

Fig. 36: Relationship between UE measurements and its consumers

The eNodeB RRC entity implements the configuration parameters and procedures described in Section 5.5.2 of [TS36331], with the following simplifying assumption:

- configuration (i.e. addition, modification, and removal) can only be done before the simulation begins;
- all UEs attached to the eNodeB will be configured the same way, i.e. there is no support for configuring specific measurement for specific UE; and
- it is assumed that there is a one-to-one mapping between the PCI and the E-UTRAN Global Cell Identifier (EGCI). This is consistent with the PCI modeling assumptions described in *UE PHY Measurements Model*.

The eNodeB RRC instance here acts as an intermediary between the consumers and the attached UEs. At the beginning of simulation, each consumer provides the eNodeB RRC instance with the UE measurements configuration that it requires. After that, the eNodeB RRC distributes the configuration to attached UEs.

Users may customize the measurement configuration using several methods. Please refer to Section *Configure UE measurements* of the User Documentation for the description of these methods.

## Performing measurements

UE RRC receives both RSRP and RSRQ measurements on periodical basis from UE PHY, as described in *UE PHY Measurements Model*. *Layer 3 filtering* will be applied to these received measurements. The implementation of the filtering follows Section 5.5.3.2 of [TS36331]:

$$F_n = (1 - a) \times F_{n-1} + a \times M_n$$

where:

- $M_n$  is the latest received measurement result from the physical layer;
- $F_n$  is the updated filtered measurement result;
- $F_{n-1}$  is the old filtered measurement result, where  $F_0 = M_1$  (i.e. the first measurement is not filtered); and
- $a = (\frac{1}{2})^{\frac{k}{4}}$ , where  $k$  is the configurable *filterCoefficient* provided by the `QuantityConfig`;

$k = 4$  is the default value, but can be configured by setting the *RsrpFilterCoefficient* and *RsrqFilterCoefficient* attributes in `LteEnbRrc`.

Therefore  $k = 0$  will disable Layer 3 filtering. On the other hand, past measurements can be granted more influence on the filtering results by using larger value of  $k$ .

## Measurement reporting triggering

In this part, UE RRC will go through the list of active measurement configuration and check whether the triggering condition is fulfilled in accordance with Section 5.5.4 of [TS36331]. When at least one triggering condition from all the active measurement configuration is fulfilled, the measurement reporting procedure (described in the next subsection) will be initiated.

3GPP defines two kinds of *triggerType*: *periodical* and *event-based*. At the moment, only event-based criterion is supported. There are various events that can be selected, which are briefly described in the table below:

Table 1: List of supported event-based triggering criteria

Name	Description
Event A1	Serving cell becomes better than <i>threshold</i>
Event A2	Serving cell becomes worse than <i>threshold</i>
Event A3	Neighbour becomes <i>offset</i> dB better than serving cell
Event A4	Neighbour becomes better than <i>threshold</i>
Event A5	Serving becomes worse than <i>threshold1</i> AND neighbour becomes better than <i>threshold2</i>

Two main conditions to be checked in an event-based trigger are the *entering condition* and the *leaving condition*. More details on these two can be found in Section 5.5.4 of [TS36331].

An event-based trigger can be further configured by introducing hysteresis and time-to-trigger. *Hysteresis (Hys)* defines the distance between the entering and leaving conditions in dB. Similarly, *time-to-trigger* introduces delay to both entering and leaving conditions, but as a unit of time.

The *periodical* type of reporting trigger is not supported, but its behavior can be easily obtained by using an event-based trigger. This can be done by configuring the measurement in such a way that the entering condition is always fulfilled, for example, by setting the threshold of Event A1 to zero (the minimum level). As a result, the measurement reports will always be triggered at every certain interval, as determined by the *reportInterval* field within `LteRrcSap::ReportConfigEutra`, therefore producing the same behaviour as periodical reporting.

As a limitation with respect to 3GPP specifications, the current model does not support any cell-specific configuration. These configuration parameters are defined in measurement object. As a consequence, incorporating a list of black cells into the triggering process is not supported. Moreover, cell-specific offset (i.e.,  $O_{cn}$  and  $O_{cp}$  in Event A3, A4, and A5) are not supported as well. The value equal to zero is always assumed in place of them.

## Measurement reporting

This part handles the submission of measurement report from the UE RRC entity to the serving eNodeB entity via RRC protocol. Several simplifying assumptions have been adopted:

- *reportAmount* is *not* applicable (i.e. always assumed to be infinite);
- in measurement reports, the *reportQuantity* is always assumed to be *BOTH*, i.e., both RSRP and RSRQ are always reported, regardless of the *triggerQuantity*.

## Handover

The RRC model supports UE mobility in CONNECTED mode by invoking the X2-based handover procedure. The model is intra-EUTRAN and intra-frequency, as based on Section 10.1.2.1 of [TS36300].

This section focuses on the process of triggering a handover. The handover execution procedure itself is covered in Section X2.

There are two ways to trigger the handover procedure:

- *explicitly* (or manually) triggered by the simulation program by scheduling an execution of the method `LteEnbRrc::SendHandoverRequest`; or
- *automatically* triggered by the eNodeB RRC entity based on UE measurements and according to the selected handover algorithm.

Section *X2-based handover* of the User Documentation provides some examples on using both explicit and automatic handover triggers in simulation. The next subsection will take a closer look on the automatic method, by describing the design aspects of the handover algorithm interface and the available handover algorithms.



## Handover algorithm

Handover in 3GPP LTE has the following properties:

- **UE-assisted** The UE provides input to the network in the form of measurement reports. This is handled by the *UE RRC Measurements Model*.
- **Network-controlled** The network (i.e. the source eNodeB and the target eNodeB) decides when to trigger the handover and oversees its execution.

The *handover algorithm* operates at the source eNodeB and is responsible in making handover decisions in an “automatic” manner. It interacts with an eNodeB RRC instance via the *Handover Management SAP* interface. These relationships are illustrated in Figure *Relationship between UE measurements and its consumers* from the previous section.

The handover algorithm interface consists of the following methods:

- **AddUeMeasReportConfigForHandover** (Handover Algorithm -> eNodeB RRC) Used by the handover algorithm to request measurement reports from the eNodeB RRC entity, by passing the desired reporting configuration. The configuration will be applied to all future attached UEs.
- **ReportUeMeas** (eNodeB RRC -> Handover Algorithm) Based on the UE measurements configured earlier in `AddUeMeasReportConfigForHandover`, UE may submit measurement reports to the eNodeB. The eNodeB RRC entity uses the `ReportUeMeas` interface to forward these measurement reports to the handover algorithm.
- **TriggerHandover** (Handover Algorithm -> eNodeB RRC) After examining the measurement reports (but not necessarily), the handover algorithm may declare a handover. This method is used to notify the eNodeB RRC entity about this decision, which will then proceed to commence the handover procedure.

One note for the `AddUeMeasReportConfigForHandover`. The method will return the `measId` (measurement identity) of the newly created measurement configuration. Typically a handover algorithm would store this unique number. It may be useful in the `ReportUeMeas` method, for example when more than one configuration has been requested and the handover algorithm needs to differentiate incoming reports based on the configuration that triggered them.

A handover algorithm is implemented by writing a subclass of the `LteHandoverAlgorithm` abstract superclass and implementing each of the above mentioned SAP interface methods. Users may develop their own handover algorithm this way, and then use it in any simulation by following the steps outlined in Section *X2-based handover* of the User Documentation.

Alternatively, users may choose to use one of the 3 built-in handover algorithms provided by the LTE module: no-op, A2-A4-RSRQ, and strongest cell handover algorithm. They are ready to be used in simulations or can be taken as an example of implementing a handover algorithm. Each of these built-in algorithms is covered in each of the following subsections.

### No-op handover algorithm

The *no-op handover algorithm* (`NoOpHandoverAlgorithm` class) is the simplest possible implementation of handover algorithm. It basically does nothing, i.e., does not call any of the Handover Management SAP interface methods. Users may choose this handover algorithm if they wish to disable automatic handover trigger in their simulation.

### A2-A4-RSRQ handover algorithm

The *A2-A4-RSRQ handover algorithm* provides the functionality of the default handover algorithm originally included in LENA M6 (ns-3.18), ported to the Handover Management SAP interface as the `A2A4RsrqHandoverAlgorithm` class.

As the name implies, the algorithm utilizes the Reference Signal Received Quality (RSRQ) measurements acquired from Event A2 and Event A4. Thus, the algorithm will add 2 measurement configuration to the corresponding eNodeB RRC instance. Their intended use are described as follows:

- *Event A2* (serving cell's RSRQ becomes worse than *threshold*) is leveraged to indicate that the UE is experiencing poor signal quality and may benefit from a handover.
- *Event A4* (neighbour cell's RSRQ becomes better than *threshold*) is used to detect neighbouring cells and acquire their corresponding RSRQ from every attached UE, which are then stored internally by the algorithm. By default, the algorithm configures Event A4 with a very low threshold, so that the trigger criteria are always true.

Figure A2-A4-RSRQ handover algorithm below summarizes this procedure.

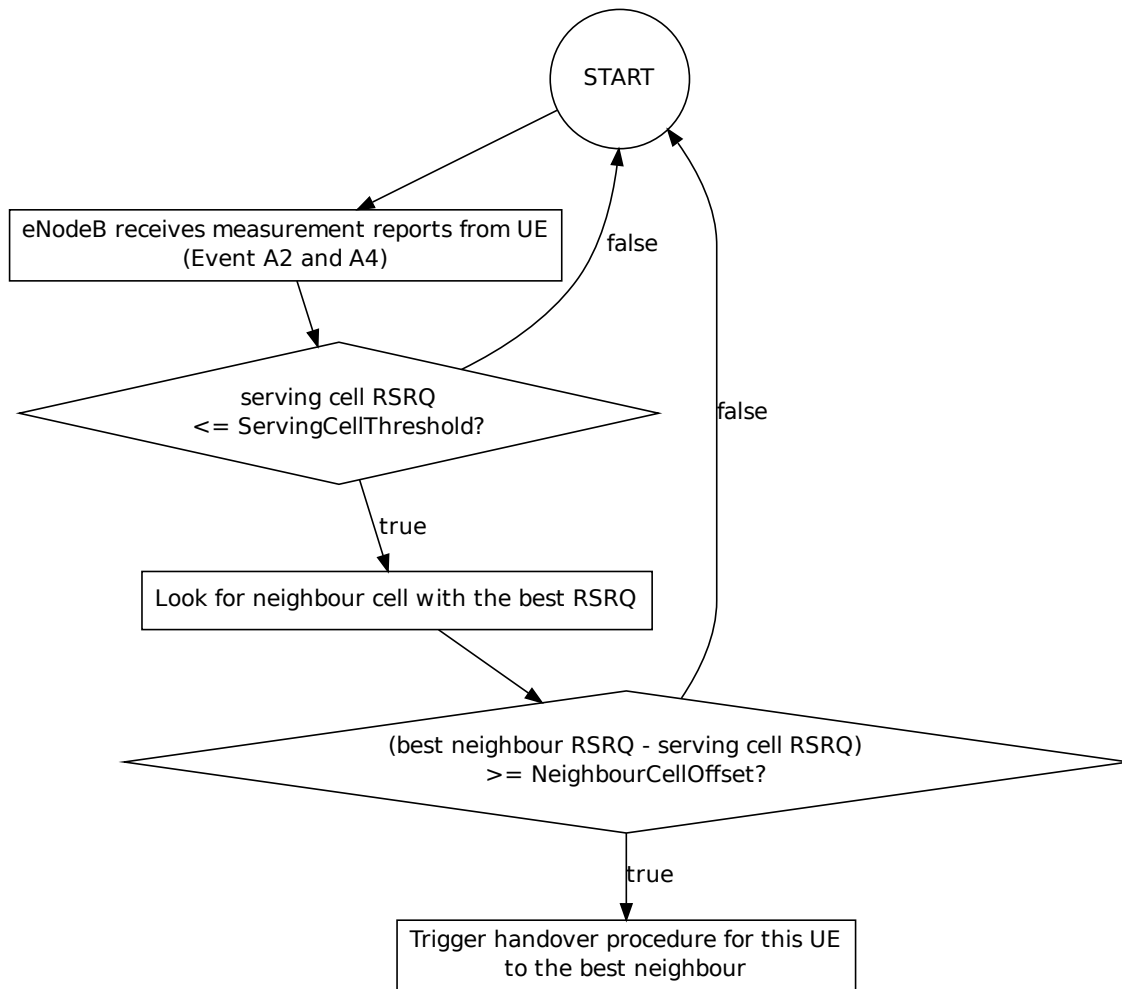

Fig. 37: A2-A4-RSRQ handover algorithm

Two attributes can be set to tune the algorithm behaviour:

- **ServingCellThreshold** The *threshold* for Event A2, i.e. a UE must have an RSRQ lower than this threshold to be considered for a handover.
- **NeighbourCellOffset** The *offset* that aims to ensure that the UE would receive better signal quality after the

handover. A neighbouring cell is considered as a target cell for the handover only if its RSRQ is higher than the serving cell's RSRQ by the amount of this *offset*.

The value of both attributes are expressed as RSRQ range (Section 9.1.7 of [TS36133]), which is an integer between 0 and 34, with 0 as the lowest RSRQ.

### Strongest cell handover algorithm

The *strongest cell handover algorithm*, or also sometimes known as the *traditional power budget (PBGT) algorithm*, is developed using [Dimou2009] as reference. The idea is to provide each UE with the best possible Reference Signal Received Power (RSRP). This is done by performing a handover as soon as a better cell (i.e. with stronger RSRP) is detected.

*Event A3* (neighbour cell's RSRP becomes better than serving cell's RSRP) is chosen to realize this concept. The `A3RsrpHandoverAlgorithm` class is the result of the implementation. Handover is triggered for the UE to the best cell in the measurement report.

A simulation which uses this algorithm is usually more vulnerable to ping-pong handover (consecutive handover to the previous source eNodeB within short period of time), especially when the *Fading Model* is enabled. This problem is typically tackled by introducing a certain delay to the handover. The algorithm does this by including hysteresis and time-to-trigger parameters (Section 6.3.5 of [TS36331]) to the UE measurements configuration.

*Hysteresis* (a.k.a. handover margin) delays the handover in regard of RSRP. The value is expressed in dB, ranges between 0 to 15 dB, and have a 0.5 dB accuracy, e.g., an input value of 2.7 dB is rounded to 2.5 dB.

On the other hand, *time-to-trigger* delays the handover in regard of time. 3GPP defines 16 valid values for time-to-trigger (all in milliseconds): 0, 40, 64, 80, 100, 128, 160, 256, 320, 480, 512, 640, 1024, 1280, 2560, and 5120.

The difference between hysteresis and time-to-trigger is illustrated in Figure *Effect of hysteresis and time-to-trigger in strongest cell handover algorithm* below, which is taken from the *lena-x2-handover-measures* example. It depicts the perceived RSRP of serving cell and a neighbouring cell by a UE which moves pass the border of the cells.

By default, the algorithm uses a hysteresis of 3.0 dB and time-to-trigger of 256 ms. These values can be tuned through the `Hysteresis` and `TimeToTrigger` attributes of the `A3RsrpHandoverAlgorithm` class.

### Neighbour Relation

LTE module supports a simplified *Automatic Neighbour Relation (ANR)* function. This is handled by the `LteAnr` class, which interacts with an eNodeB RRC instance through the ANR SAP interface.

### Neighbour Relation Table

The ANR holds a *Neighbour Relation Table (NRT)*, similar to the description in Section 22.3.2a of [TS36300]. Each entry in the table is called a *Neighbour Relation (NR)* and represents a detected neighbouring cell, which contains the following boolean fields:

- **No Remove** Indicates that the NR shall *not* be removed from the NRT. This is *true* by default for user-provided NR and *false* otherwise.
- **No X2** Indicates that the NR shall *not* use an X2 interface in order to initiate procedures towards the eNodeB parenting the target cell. This is *false* by default for user-provided NR, and *true* otherwise.
- **No HO** Indicates that the NR shall *not* be used by the eNodeB for handover reasons. This is *true* in most cases, except when the NR is both user-provided and network-detected.

Each NR entry may have at least one of the following properties:

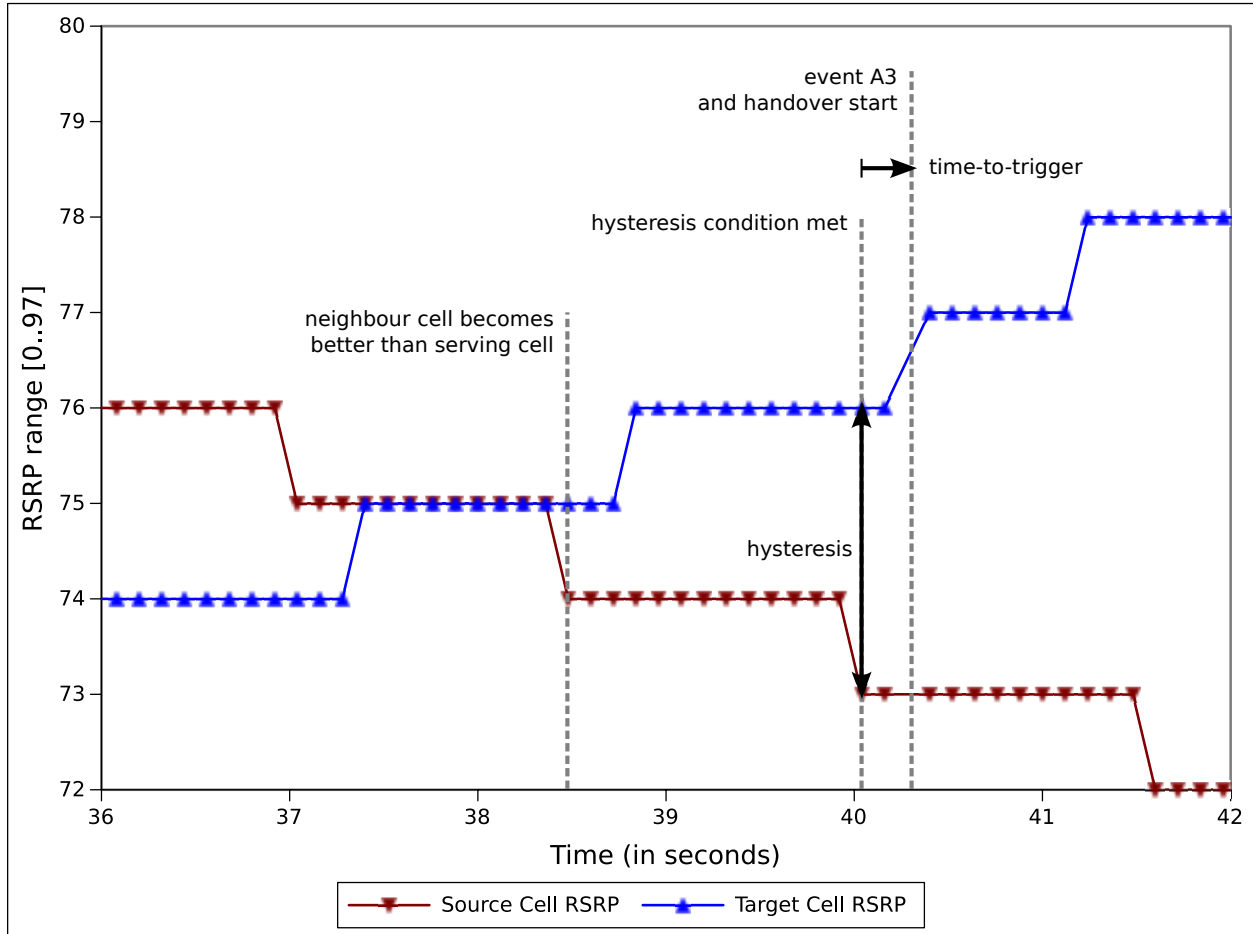

Fig. 38: Effect of hysteresis and time-to-trigger in strongest cell handover algorithm

- **User-provided** This type of NR is created as instructed by the simulation user. For example, a NR is created automatically upon a user-initiated establishment of X2 connection between 2 eNodeBs, e.g. as described in Section *X2-based handover*. Another way to create a user-provided NR is to call the `AddNeighbourRelation` function explicitly.
- **Network-detected** This type of NR is automatically created during the simulation as a result of the discovery of a nearby cell.

In order to automatically create network-detected NR, ANR utilizes UE measurements. In other words, ANR is a consumer of UE measurements, as depicted in Figure *Relationship between UE measurements and its consumers*. RSRQ and Event A4 (neighbour becomes better than *threshold*) are used for the reporting configuration. The default Event A4 *threshold* is set to the lowest possible, i.e., maximum detection capability, but can be changed by setting the `Threshold` attribute of `LteAnr` class. Note that the A2-A4-RSRQ handover algorithm also utilizes a similar reporting configuration. Despite the similarity, when both ANR and this handover algorithm are active in the eNodeB, they use separate reporting configuration.

Also note that automatic setup of X2 interface is not supported. This is the reason why the *No X2* and *No HO* fields are true in a network-detected but not user-detected NR.

## Role of ANR in Simulation

The ANR SAP interface provides the means of communication between ANR and eNodeB RRC. Some interface functions are used by eNodeB RRC to interact with the NRT, as shown below:

- **AddNeighbourRelation** (eNodeB RRC -> ANR) Add a new user-provided NR entry into the NRT.
- **GetNoRemove** (eNodeB RRC -> ANR) Get the value of *No Remove* field of an NR entry of the given cell ID.
- **GetNoHo** (eNodeB RRC -> ANR) Get the value of *No HO* field of an NR entry of the given cell ID.
- **GetNoX2** (eNodeB RRC -> ANR) Get the value of *No X2* field of an NR entry of the given cell ID.

Other interface functions exist to support the role of ANR as a UE measurements consumer, as listed below:

- **AddUeMeasReportConfigForAnr** (ANR -> eNodeB RRC) Used by the ANR to request measurement reports from the eNodeB RRC entity, by passing the desired reporting configuration. The configuration will be applied to all future attached UEs.
- **ReportUeMeas** (eNodeB RRC -> ANR) Based on the UE measurements configured earlier in `AddUeMeasReportConfigForAnr`, UE may submit measurement reports to the eNodeB. The eNodeB RRC entity uses the `ReportUeMeas` interface to forward these measurement reports to the ANR.

Please refer to the corresponding API documentation for `LteAnrSap` class for more details on the usage and the required parameters.

The ANR is utilized by the eNodeB RRC instance as a data structure to keep track of the situation of nearby neighbouring cells. The ANR also helps the eNodeB RRC instance to determine whether it is possible to execute a handover procedure to a neighbouring cell. This is realized by the fact that eNodeB RRC will only allow a handover procedure to happen if the NR entry of the target cell has both *No HO* and *No X2* fields set to *false*.

ANR is enabled by default in every eNodeB instance in the simulation. It can be disabled by setting the `AnrEnabled` attribute in `LteHelper` class to *false*.

## RRC sequence diagrams

In this section we provide some sequence diagrams that explain the most important RRC procedures being modeled.

### RRC connection establishment

Figure *Sequence diagram of the RRC Connection Establishment procedure* shows how the RRC Connection Establishment procedure is modeled, highlighting the role of the RRC layer at both the UE and the eNB, as well as the interaction with the other layers.

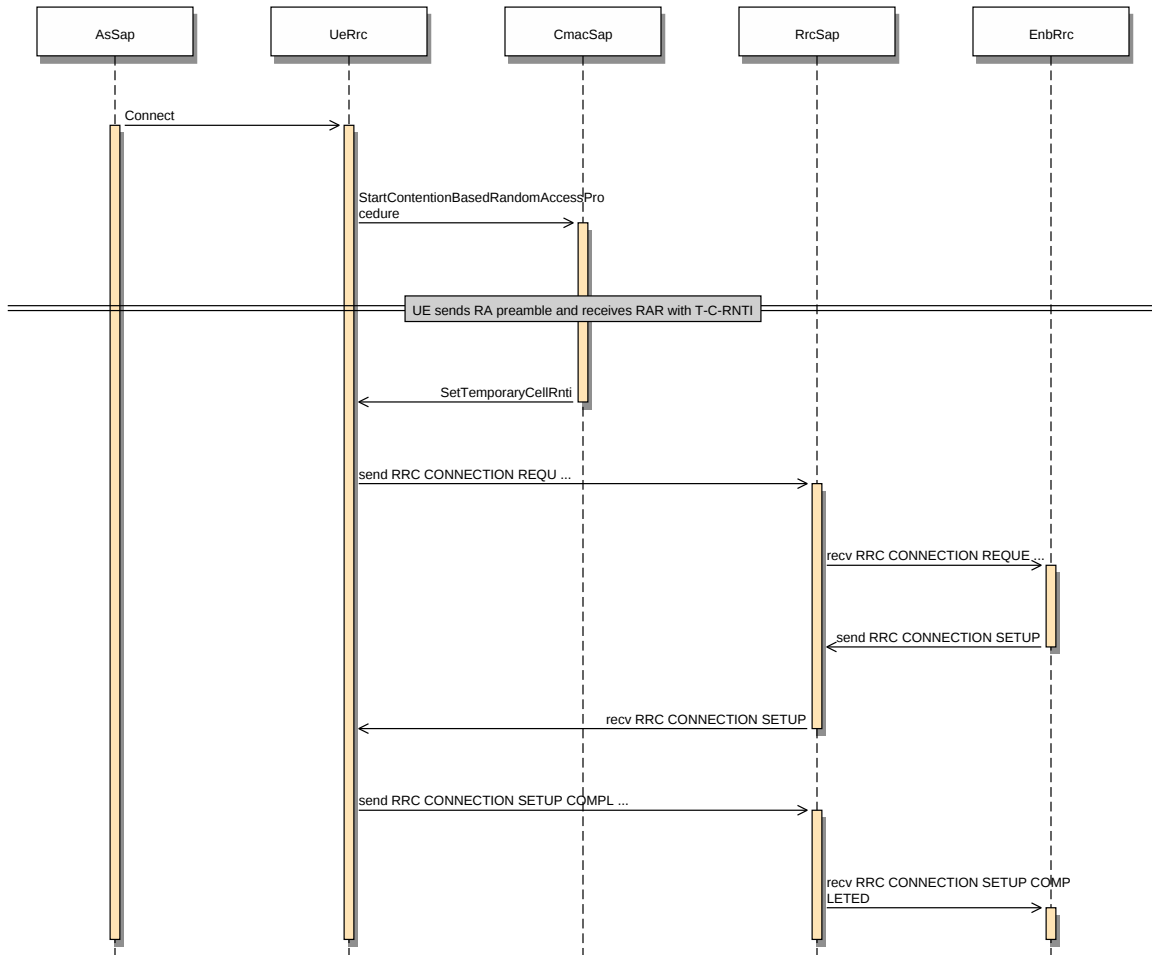

Fig. 39: Sequence diagram of the RRC Connection Establishment procedure

There are several timeouts related to this procedure, which are listed in the following Table *Timers in RRC connection establishment procedure*. If any of these timers expired, the RRC connection establishment procedure is terminated in failure. At the UE side, if T300 timer has expired a consecutive *connEstFailCount* times on the same cell it performs the cell selection again [TS36331]. Else, the upper layer (UE NAS) will immediately attempt to retry the procedure.

Table 2: Timers in RRC connection establishment procedure

Name	Location	Timer starts	Timer stops	Default duration	When timer expired
Connection request timeout	eNodeB RRC	New UE context added	Receive RRC CONNECTION REQUEST	15 ms (Max)	Remove UE context
Connection timeout (T300 timer)	UE RRC	Send RRC CONNECTION REQUEST	Receive RRC CONNECTION SETUP or REJECT	100 ms	Reset UE MAC
Connection setup timeout	eNodeB RRC	Send RRC CONNECTION SETUP	Receive RRC CONNECTION SETUP COMPLETE	100 ms	Remove UE context
Connection rejected timeout	eNodeB RRC	Send RRC CONNECTION REJECT	Never	30 ms	Remove UE context

**Note:** The value of connection request timeout timer at the eNB RRC should not be higher than the T300 timer at UE RRC. It is to make sure that the UE context is already removed at the eNB, once the UE will perform cell selection upon reaching the *connEstFailCount* count. Moreover, at the time of writing this document the *Cell Selection Evaluation* does not include the *Qoffset<sub>temp</sub>* parameter, thus, it is not applied while selecting the same cell again.

Table 3: Counters in RRC connection establishment procedure

Name	Location	Msg	Monitored by	Default value	Limit not reached	Limit reached
ConnEst-Fail-Count	eNB MAC	RachConfigCommon in SIB2, HO REQ and HO Ack	UE RRC	1	Increment the local counter. Invalidated the prev SIB2 msg, and try random access with the same cell.	Reset the local counter and perform cell selection.

## RRC connection reconfiguration

Figure *Sequence diagram of the RRC Connection Reconfiguration procedure* shows how the RRC Connection Reconfiguration procedure is modeled for the case where MobilityControlInfo is not provided, i.e., handover is not performed.

Figure *Sequence diagram of the RRC Connection Reconfiguration procedure for the handover case* shows how the RRC Connection Reconfiguration procedure is modeled for the case where MobilityControlInfo is provided, i.e., handover is to be performed. As specified in [TS36331], *After receiving the handover message, the UE attempts to access the target cell at the first available RACH occasion according to Random Access resource selection defined in [TS36321], i.e. the handover is asynchronous. Consequently, when allocating a dedicated preamble for the random access in the target cell, E-UTRA shall ensure it is available from the first RACH occasion the UE may use. Upon successful completion of the handover, the UE sends a message used to confirm the handover.* Note that the random access procedure in this case is non-contention based, hence in a real LTE system it differs slightly from the one used in RRC connection established. Also note that the RA Preamble ID is signaled via the Handover Command included in the X2 Handover Request ACK message sent from the target eNB to the source eNB; in particular, the preamble is included in the RACH-ConfigDedicated IE which is part of MobilityControlInfo.

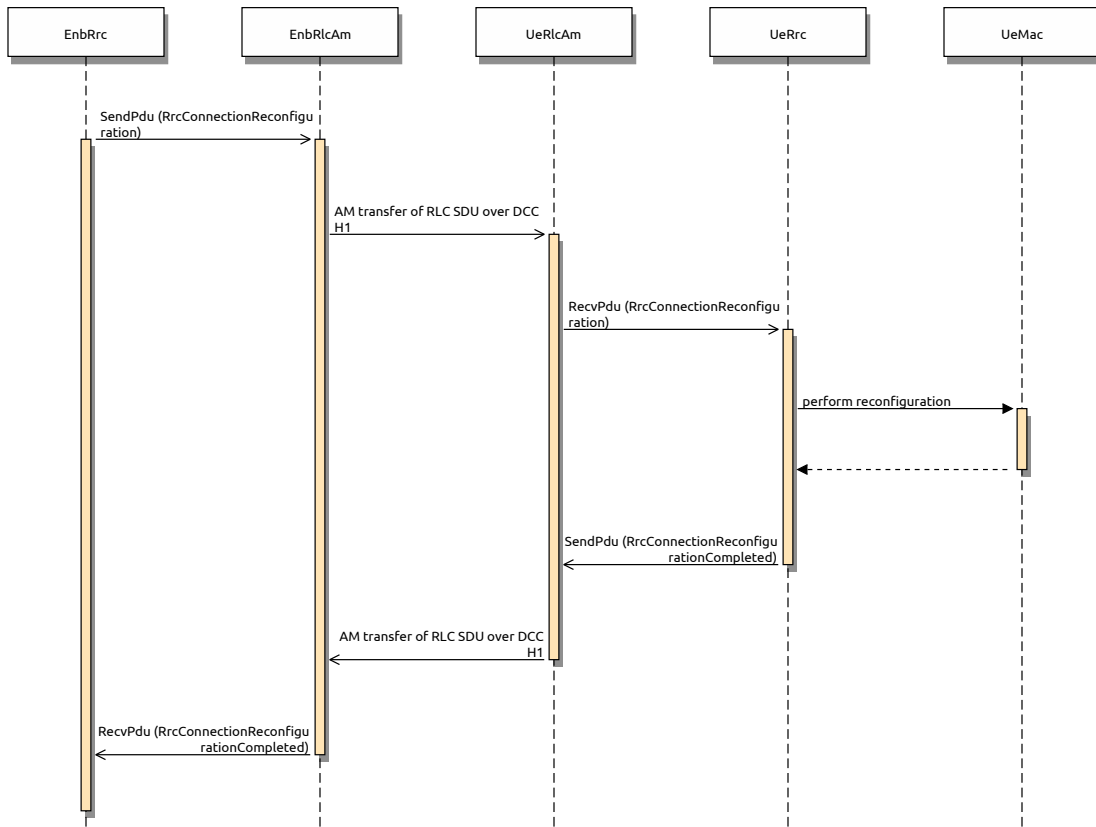
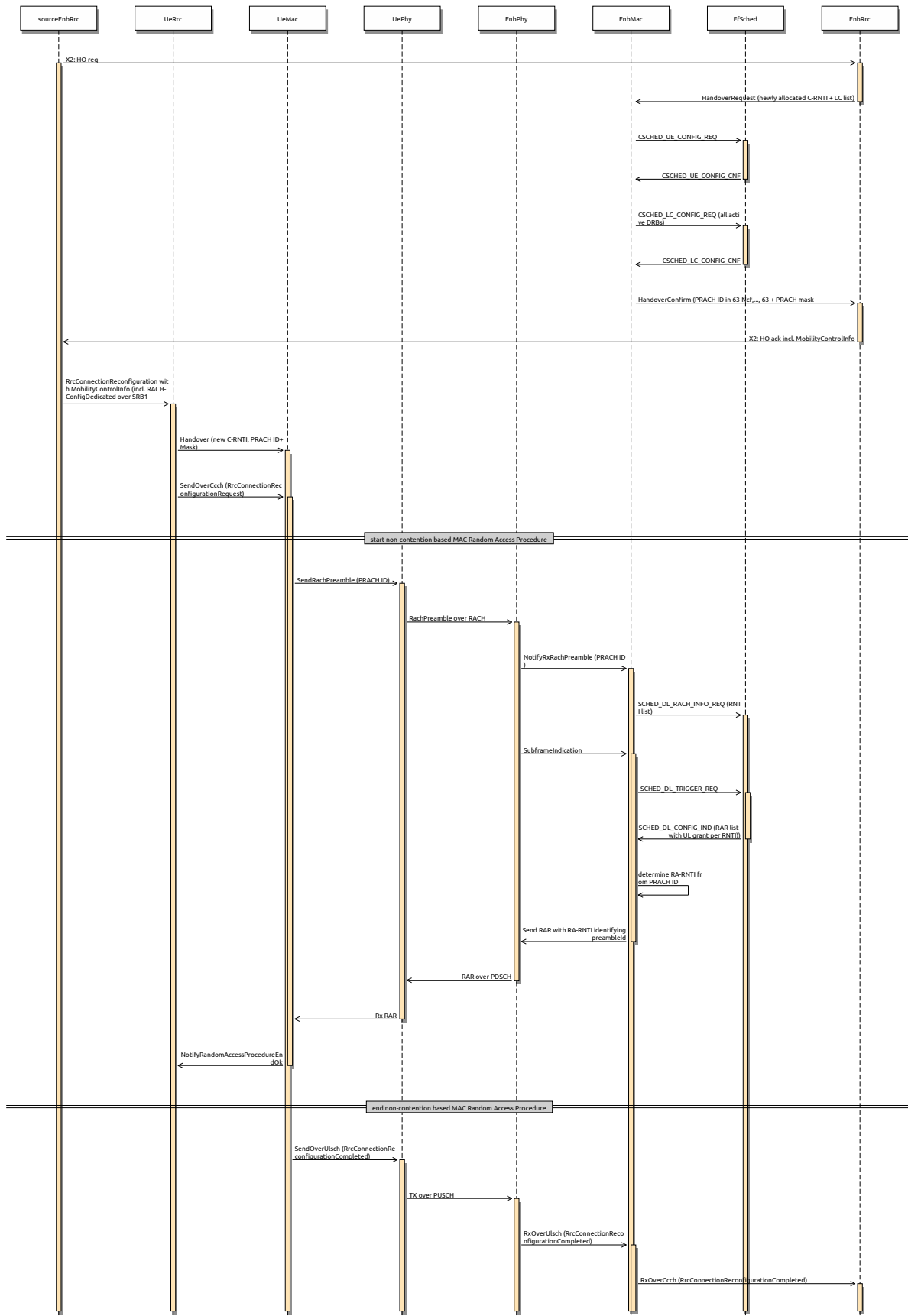

Fig. 40: Sequence diagram of the RRC Connection Reconfiguration procedure





## RRC protocol models

As previously anticipated, we provide two different models for the transmission and reception of RRC messages: *Ideal* and *Real*. Each of them is described in one of the following subsections.

### Ideal RRC protocol model

According to this model, implemented in the classes *LteUeRrcProtocolIdeal* and *LteEnbRrcProtocolIdeal*, all RRC messages and information elements are transmitted between the eNB and the UE in an ideal fashion, without consuming radio resources and without errors. From an implementation point of view, this is achieved by passing the RRC data structure directly between the UE and eNB RRC entities, without involving the lower layers (PDCP, RLC, MAC, scheduler).

### Real RRC protocol model

This model is implemented in the classes *LteUeRrcProtocolReal* and *LteEnbRrcProtocolReal* and aims at modeling the transmission of RRC PDUs as commonly performed in real LTE systems. In particular:

- for every RRC message being sent, a real RRC PDUs is created following the ASN.1 encoding of RRC PDUs and information elements (IEs) specified in [TS36331]. Some simplification are made with respect to the IEs included in the PDU, i.e., only those IEs that are useful for simulation purposes are included. For a detailed list, please see the IEs defined in *lte-rrc-sap.h* and compare with [TS36331].
- the encoded RRC PDUs are sent on Signaling Radio Bearers and are subject to the same transmission modeling used for data communications, thus including scheduling, radio resource consumption, channel errors, delays, retransmissions, etc.

### Signaling Radio Bearer model

We now describe the Signaling Radio Bearer model that is used for the *Real* RRC protocol model.

- **SRB0** messages (over CCCH):
  - **RrcConnectionRequest**: in real LTE systems, this is an RLC TM SDU sent over resources specified in the UL Grant in the RAR (not in UL DCIs); the reason is that C-RNTI is not known yet at this stage. In the simulator, this is modeled as a real RLC TM RLC PDU whose UL resources are allocated by the scheduler upon call to `SCHED_DL_RACH_INFO_REQ`.
  - **RrcConnectionSetup**: in the simulator this is implemented as in real LTE systems, i.e., with an RLC TM SDU sent over resources indicated by a regular UL DCI, allocated with `SCHED_DL_RLC_BUFFER_REQ` triggered by the RLC TM instance that is mapped to LCID 0 (the CCCH).
- **SRB1** messages (over DCCH):
  - All the SRB1 messages modeled in the simulator (e.g., **RrcConnectionCompleted**) are implemented as in real LTE systems, i.e., with a real RLC SDU sent over RLC AM using DL resources allocated via Buffer Status Reports. See the RLC model documentation for details.
- **SRB2** messages (over DCCH):
  - According to [TS36331], “*SRB1 is for RRC messages (which may include a piggybacked NAS message) as well as for NAS messages prior to the establishment of SRB2, all using DCCH logical channel*”, whereas “*SRB2 is for NAS messages, using DCCH logical channel*” and “*SRB2 has a lower-priority than SRB1 and is always configured by E-UTRAN after security activation*”. Modeling security-related aspects is not a requirement of the LTE simulation model, hence we always use SRB1 and never activate SRB2.

## ASN.1 encoding of RRC IE's

The messages defined in RRC SAP, common to all Ue/Enb SAP Users/Providers, are transported in a transparent container to/from a Ue/Enb. The encoding format for the different Information Elements are specified in [TS36331], using ASN.1 rules in the unaligned variant. The implementation in Ns3/Lte has been divided in the following classes:

- Asn1Header : Contains the encoding / decoding of basic ASN types
- RrcAsn1Header : Inherits Asn1Header and contains the encoding / decoding of common IE's defined in [TS36331]
- Rrc specific messages/IEs classes : A class for each of the messages defined in RRC SAP header

### Asn1Header class - Implementation of base ASN.1 types

This class implements the methods to Serialize / Deserialize the ASN.1 types being used in [TS36331], according to the packed encoding rules in ITU-T X.691. The types considered are:

- Boolean : a boolean value uses a single bit (1=true, 0=false).
- Integer : a constrained integer (with min and max values defined) uses the minimum amount of bits to encode its range (max-min+1).
- Bitstring : a bistring will be copied bit by bit to the serialization buffer.
- Octetstring : not being currently used.
- Sequence : the sequence generates a preamble indicating the presence of optional and default fields. It also adds a bit indicating the presence of extension marker.
- Sequence...Of : the sequence...of type encodes the number of elements of the sequence as an integer (the subsequent elements will need to be encoded afterwards).
- Choice : indicates which element among the ones in the choice set is being encoded.
- Enumeration : is serialized as an integer indicating which value is used, among the ones in the enumeration, with the number of elements in the enumeration as upper bound.
- Null : the null value is not encoded, although its serialization function is defined to provide a clearer map between specification and implementation.

The class inherits from ns-3 Header, but Deserialize() function is declared pure virtual, thus inherited classes having to implement it. The reason is that deserialization will retrieve the elements in RRC messages, each of them containing different information elements.

Additionally, it has to be noted that the resulting byte length of a specific type/message can vary, according to the presence of optional fields, and due to the optimized encoding. Hence, the serialized bits will be processed using PreSerialize() function, saving the result in m\_serializationResult Buffer. As the methods to read/write in a ns3 buffer are defined in a byte basis, the serialization bits are stored into m\_serializationPendingBits attribute, until the 8 bits are set and can be written to buffer iterator. Finally, when invoking Serialize(), the contents of the m\_serializationResult attribute will be copied to Buffer::Iterator parameter

### RrcAsn1Header : Common IEs

As some Information Elements are being used for several RRC messages, this class implements the following common IE's:

- SrbToAddModList
- DrbToAddModList

- LogicalChannelConfig
- RadioResourceConfigDedicated
- PhysicalConfigDedicated
- SystemInformationBlockType1
- SystemInformationBlockType2
- RadioResourceConfigCommonSIB

### **Rrc specific messages/IEs classes**

The following RRC SAP have been implemented:

- RrcConnectionRequest
- RrcConnectionSetup
- RrcConnectionSetupCompleted
- RrcConnectionReconfiguration
- RrcConnectionReconfigurationCompleted
- HandoverPreparationInfo
- RrcConnectionReestablishmentRequest
- RrcConnectionReestablishment
- RrcConnectionReestablishmentComplete
- RrcConnectionReestablishmentReject
- RrcConnectionRelease

### 19.1.11 NAS

The focus of the LTE-EPC model is on the NAS Active state, which corresponds to EMM Registered, ECM connected, and RRC connected. Because of this, the following simplifications are made:

- EMM and ECM are not modeled explicitly; instead, the NAS entity at the UE will interact directly with the MME to perform actions that are equivalent (with gross simplifications) to taking the UE to the states EMM Connected and ECM Connected;
- the NAS also takes care of multiplexing uplink data packets coming from the upper layers into the appropriate EPS bearer by using the Traffic Flow Template classifier (TftClassifier).
- the NAS does not support PLMN and CSG selection
- the NAS does not support any location update/paging procedure in idle mode

Figure *Sequence diagram of the attach procedure* shows how the simplified NAS model implements the attach procedure. Note that both the default and eventual dedicated EPS bearers are activated as part of this procedure.

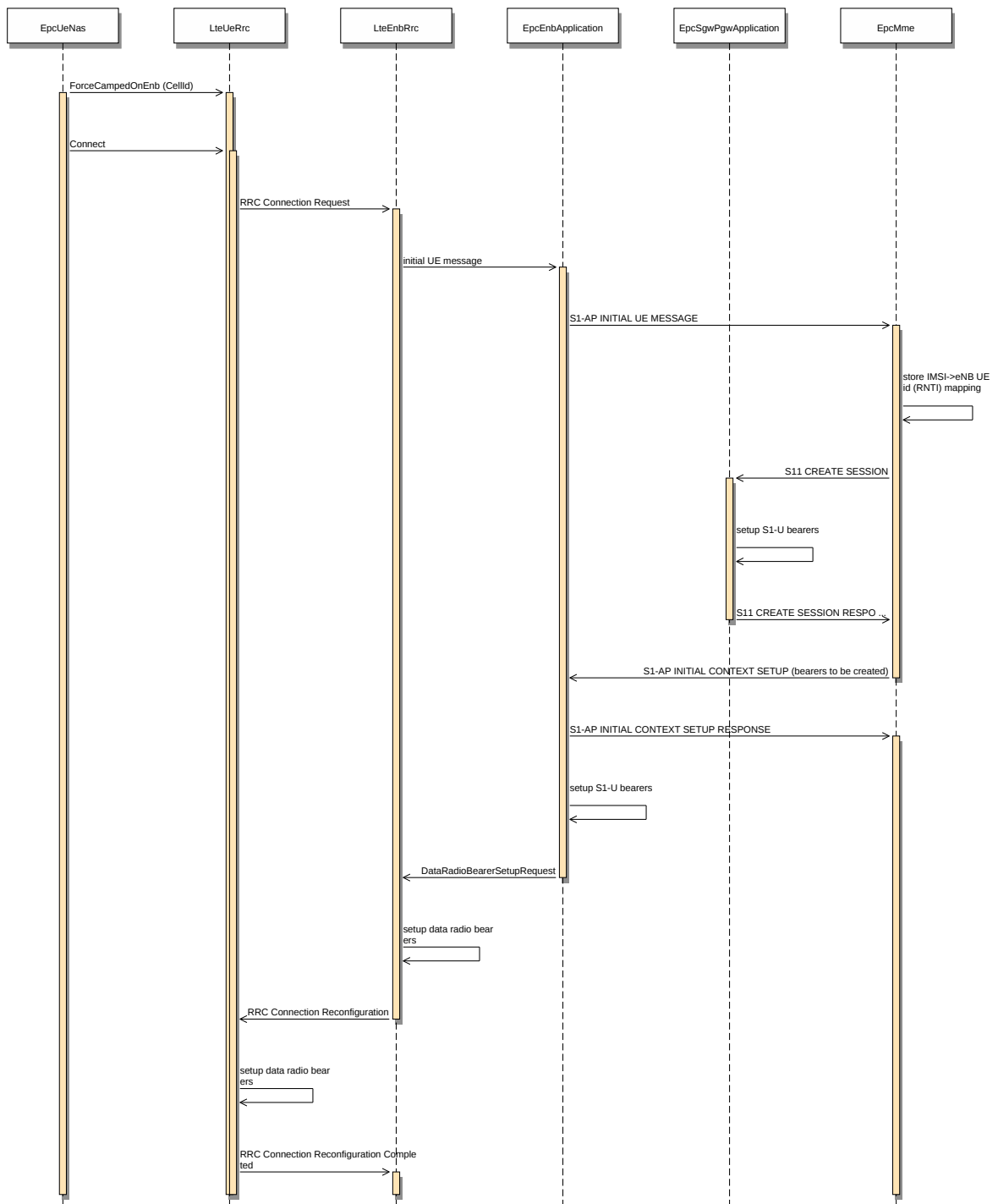

Fig. 42: Sequence diagram of the attach procedure

## 19.1.12 S1, S5 and S11

### S1-U and S5 (user plane)

The S1-U and S5 interfaces are modeled in a realistic way by encapsulating data packets over GTP/UDP/IP, as done in real LTE-EPC systems. The corresponding protocol stack is shown in Figure *LTE-EPC data plane protocol stack*. As shown in the figure, there are two different layers of IP networking. The first one is the end-to-end layer, which provides end-to-end connectivity to the users; this layer involves the UEs, the PGW and the remote host (including eventual internet routers and hosts in between), but does not involve the eNB and the SGW. In this version of LTE, the EPC supports both IPv4 and IPv6 type users. The 3GPP unique 64 bit IPv6 prefix allocation process for each UE and PGW is followed here. Each EPC is assigned a unique 16 bit IPv4 and a 48 bit IPv6 network address from the pool of 7.0.0.0/8 and 7777:f00d::/32 respectively. In the end-to-end IP connection between UE and PGW, all addresses are configured using these prefixes. The PGW's address is used by all UEs as the gateway to reach the internet.

The second layer of IP networking is the EPC local area network. This involves all eNB nodes, SGW nodes and PGW nodes. This network is implemented as a set of point-to-point links which connect each eNB with its corresponding SGW node and a point-to-point link which connect each SGW node with its corresponding PGW node; thus, each SGW has a set of point-to-point devices, each providing connectivity to a different eNB. By default, a 10.x.y.z/30 subnet is assigned to each point-to-point link (a /30 subnet is the smallest subnet that allows for two distinct host addresses).

As specified by 3GPP, the end-to-end IP communications is tunneled over the local EPC IP network using GTP/UDP/IP. In the following, we explain how this tunneling is implemented in the EPC model. The explanation is done by discussing the end-to-end flow of data packets.

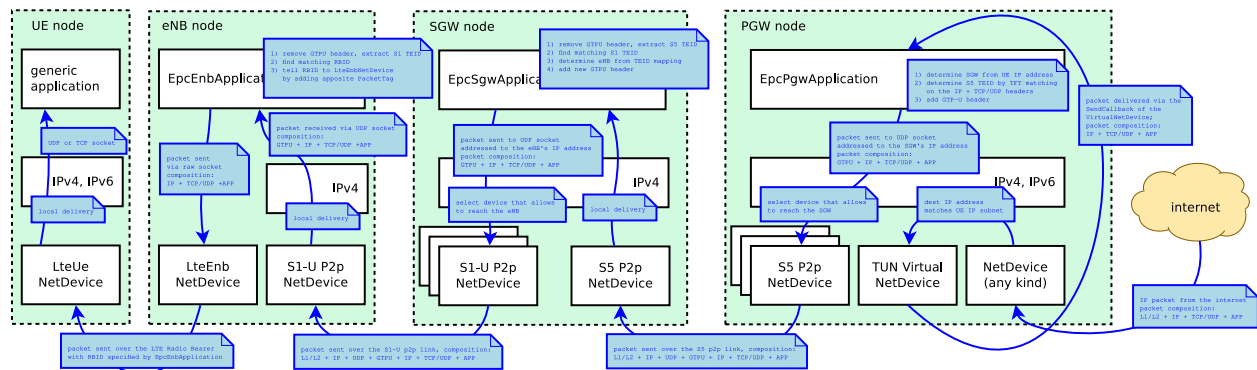

Fig. 43: Data flow in the downlink between the internet and the UE

To begin with, we consider the case of the downlink, which is depicted in Figure *Data flow in the downlink between the internet and the UE*. Downlink IPv4/IPv6 packets are generated from a generic remote host, and addressed to one of the UE device. Internet routing will take care of forwarding the packet to the generic NetDevice of the PGW node which is connected to the internet (this is the Gi interface according to 3GPP terminology). The PGW has a VirtualNetDevice which is assigned the base IPv4 address of the EPC network; hence, static routing rules will cause the incoming packet from the internet to be routed through this VirtualNetDevice. In case of IPv6 address as destination, a manual route towards the VirtualNetDevice is inserted in the routing table, containing the 48 bit IPv6 prefix from which all the IPv6 addresses of the UEs and PGW are configured. Such device starts the GTP/UDP/IP tunneling procedure, by forwarding the packet to a dedicated application in the PGW node which is called EpcPgwApplication. This application does the following operations:

1. it determines the SGW node to which it must route the traffic for this UE, by looking at the IP destination address (which is the address of the UE);
2. it classifies the packet using Traffic Flow Templates (TFTs) to identify to which EPS Bearer it belongs. EPS bearers have a one-to-one mapping to S5 Bearers, so this operation returns the GTP-U Tunnel Endpoint Identifier (TEID) to which the packet belongs;

3. it adds the corresponding GTP-U protocol header to the packet;
4. finally, it sends the packet over a UDP socket to the S5 point-to-point NetDevice, addressed to the appropriate SGW.

As a consequence, the end-to-end IP packet with newly added IP, UDP and GTP headers is sent through one of the S5 links to the SGW, where it is received and delivered locally (as the destination address of the outermost IP header matches the SGW IP address). The local delivery process will forward the packet, via an UDP socket, to a dedicated application called EpcSgwApplication. This application then performs the following operations:

1. it determines the eNB node to which the UE is attached, by looking at the S5 TEID;
2. it maps the S5 TEID to get the S1 TEID. EPS bearers have a one-to-one mapping to S1-U Bearers, so this operation returns the S1 GTP-U Tunnel Endpoint Identifier (TEID) to which the packet belongs;
3. it adds a new GTP-U protocol header to the packet;
4. finally, it sends the packet over a UDP socket to the S1-U point-to-point NetDevice, addressed to the eNB to which the UE is attached.

Finally, the end-to-end IP packet with newly added IP, UDP and GTP headers is sent through one of the S1 links to the eNB, where it is received and delivered locally (as the destination address of the outermost IP header matches the eNB IP address). The local delivery process will forward the packet, via an UDP socket, to a dedicated application called EpcEnbApplication. This application then performs the following operations:

1. it removes the GTP header and retrieves the S1 TEID which is contained in it;
2. leveraging on the one-to-one mapping between S1-U bearers and Radio Bearers (which is a 3GPP requirement), it determines the Bearer ID (BID) to which the packet belongs;
3. it records the BID in a dedicated tag called EpsBearerTag, which is added to the packet;
4. it forwards the packet to the LteEnbNetDevice of the eNB node via a raw packet socket

Note that, at this point, the outmost header of the packet is the end-to-end IP header, since the IP/UDP/GTP headers of the S1 protocol stack have already been stripped. Upon reception of the packet from the EpcEnbApplication, the LteEnbNetDevice will retrieve the BID from the EpsBearerTag, and based on the BID will determine the Radio Bearer instance (and the corresponding PDCP and RLC protocol instances) which are then used to forward the packet to the UE over the LTE radio interface. Finally, the LteUeNetDevice of the UE will receive the packet, and delivery it locally to the IP protocol stack, which will in turn delivery it to the application of the UE, which is the end point of the downlink communication.

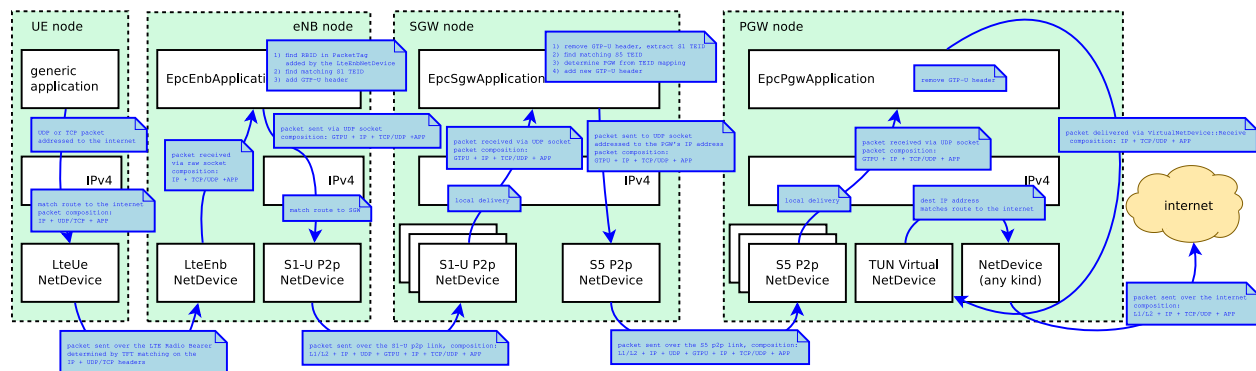

Fig. 44: Data flow in the uplink between the UE and the internet

The case of the uplink is depicted in Figure *Data flow in the uplink between the UE and the internet*. Uplink IP packets are generated by a generic application inside the UE, and forwarded by the local TCP/IP stack to the LteUeNetDevice of the UE. The LteUeNetDevice then performs the following operations:



1. it classifies the packet using TFTs and determines the Radio Bearer to which the packet belongs (and the corresponding RBID);
2. it identifies the corresponding PDCP protocol instance, which is the entry point of the LTE Radio Protocol stack for this packet;
3. it sends the packet to the eNB over the LTE Radio Protocol stack.

The eNB receives the packet via its `LteEnbNetDevice`. Since there is a single PDCP and RLC protocol instance for each Radio Bearer, the `LteEnbNetDevice` is able to determine the BID of the packet. This BID is then recorded onto an `EpsBearerTag`, which is added to the packet. The `LteEnbNetDevice` then forwards the packet to the `EpcEnbApplication` via a raw packet socket.

Upon receiving the packet, the `EpcEnbApplication` performs the following operations:

1. it retrieves the BID from the `EpsBearerTag` in the packet;
2. it determines the corresponding EPS Bearer instance and GTP-U TEID by leveraging on the one-to-one mapping between S1-U bearers and Radio Bearers;
3. it adds a GTP-U header on the packet, including the TEID determined previously;
4. it sends the packet to the SGW node via the UDP socket connected to the S1-U point-to-point net device.

At this point, the packet contains the S1-U IP, UDP and GTP headers in addition to the original end-to-end IP header. When the packet is received by the corresponding S1-U point-to-point `NetDevice` of the SGW node, it is delivered locally (as the destination address of the outmost IP header matches the address of the point-to-point net device). The local delivery process will forward the packet to the `EpcSgwApplication` via the corresponding UDP socket. The `EpcSgwApplication` then performs the following operations:

1. it removes the GTP header and retrieves the S1-U TEID;
2. it maps the S1-U TEID to get the S5 TEID to which the packet belongs;
3. it determines the PGW to which it must send the packet from the TEID mapping;
4. it add a new GTP-U protocol header to the packet;
5. finally, it sends the packet over a UDP socket to the S5 point-to-point `NetDevice`, addressed to the corresponding PGW.

At this point, the packet contains the S5 IP, UDP and GTP headers in addition to the original end-to-end IP header. When the packet is received by the corresponding S5 point-to-point `NetDevice` of the PGW node, it is delivered locally (as the destination address of the outmost IP header matches the address of the point-to-point net device). The local delivery process will forward the packet to the `EpcPgwApplication` via the corresponding UDP socket. The `EpcPgwApplication` then removes the GTP header and forwards the packet to the `VirtualNetDevice`. At this point, the outmost header of the packet is the end-to-end IP header. Hence, if the destination address within this header is a remote host on the internet, the packet is sent to the internet via the corresponding `NetDevice` of the PGW. In the event that the packet is addressed to another UE, the IP stack of the PGW will redirect the packet again to the `VirtualNetDevice`, and the packet will go through the downlink delivery process in order to reach its destination UE.

Note that the EPS Bearer QoS is not enforced on the S1-U and S5 links, it is assumed that the overprovisioning of the link bandwidth is sufficient to meet the QoS requirements of all bearers.

## S1AP

The S1-AP interface provides control plane interaction between the eNB and the MME. In the simulator, this interface is modeled in a realistic fashion transmitting the encoded S1AP messages and information elements specified in [TS36413] on the S1-MME link.

The S1-AP primitives that are modeled are:

- INITIAL UE MESSAGE
- INITIAL CONTEXT SETUP REQUEST
- INITIAL CONTEXT SETUP RESPONSE
- PATH SWITCH REQUEST
- PATH SWITCH REQUEST ACKNOWLEDGE

## S5 and S11

The S5 interface provides control plane interaction between the SGW and the PGW. The S11 interface provides control plane interaction between the SGW and the MME. Both interfaces use the GPRS Tunneling Protocol (GTPv2-C) to tunnel signalling messages [TS29274] and use UDP as transport protocol. In the simulator, these interfaces and protocol are modeled in a realistic fashion transmitting the encoded GTP-C messages.

The GTPv2-C primitives that are modeled are:

- CREATE SESSION REQUEST
- CREATE SESSION RESPONSE
- MODIFY BEARER REQUEST
- MODIFY BEARER RESPONSE
- DELETE SESSION REQUEST
- DELETE SESSION RESPONSE
- DELETE BEARER COMMAND
- DELETE BEARER REQUEST
- DELETE BEARER RESPONSE

Of these primitives, the first two are used upon initial UE attachment for the establishment of the S1-U and S5 bearers. Section *NAS* shows the implementation of the attach procedure. The other primitives are used during the handover to switch the S1-U bearers from the source eNB to the target eNB as a consequence of the reception by the MME of a PATH SWITCH REQUEST S1-AP message.

### 19.1.13 X2

The X2 interface interconnects two eNBs [TS36420]. From a logical point of view, the X2 interface is a point-to-point interface between the two eNBs. In a real E-UTRAN, the logical point-to-point interface should be feasible even in the absence of a physical direct connection between the two eNBs. In the X2 model implemented in the simulator, the X2 interface is a point-to-point link between the two eNBs. A point-to-point device is created in both eNBs and the two point-to-point devices are attached to the point-to-point link.

For a representation of how the X2 interface fits in the overall architecture of the LENA simulation model, the reader is referred to the figure *Overview of the LTE-EPC simulation model*.

The X2 interface implemented in the simulator provides detailed implementation of the following elementary procedures of the Mobility Management functionality [TS36423]:

- Handover Request procedure
- Handover Request Acknowledgement procedure
- SN Status Transfer procedure
- UE Context Release procedure

These procedures are involved in the X2-based handover. You can find the detailed description of the handover in section 10.1.2.1 of [TS36300]. We note that the simulator model currently supports only the *seamless handover* as defined in Section 2.6.3.1 of [Sesia2009]; in particular, *lossless handover* as described in Section 2.6.3.2 of [Sesia2009] is not supported at the time of this writing.

Figure *Sequence diagram of the X2-based handover* below shows the interaction of the entities of the X2 model in the simulator. The shaded labels indicate the moments when the UE or eNodeB transition to another RRC state.

The figure also shows two timers within the handover procedure: the *handover leaving timer* is maintained by the source eNodeB, while the *handover joining timer* by the target eNodeB. The duration of the timers can be configured in the `HandoverLeavingTimeoutDuration` and `HandoverJoiningTimeoutDuration` attributes of the respective `LteEnbRrc` instances. When one of these timers expire, the handover procedure is considered as failed.

However, there is no proper handling of handover failure in the current version of LTE module. Users should tune the simulation properly in order to avoid handover failure, otherwise unexpected behaviour may occur. Please refer to Section *Tuning simulation with handover* of the User Documentation for some tips regarding this matter.

The X2 model is an entity that uses services from:

- the X2 interfaces,
  - They are implemented as Sockets on top of the point-to-point devices.
  - They are used to send/receive X2 messages through the X2-C and X2-U interfaces (i.e. the point-to-point device attached to the point-to-point link) towards the peer eNB.
- the S1 application.
  - Currently, it is the `EpcEnbApplication`.
  - It is used to get some information needed for the Elementary Procedures of the X2 messages.

and it provides services to:

- the RRC entity (X2 SAP)
  - to send/receive RRC messages. The X2 entity sends the RRC message as a transparent container in the X2 message. This RRC message is sent to the UE.

Figure *Implementation Model of X2 entity and SAPs* shows the implementation model of the X2 entity and its relationship with all the other entities and services in the protocol stack.

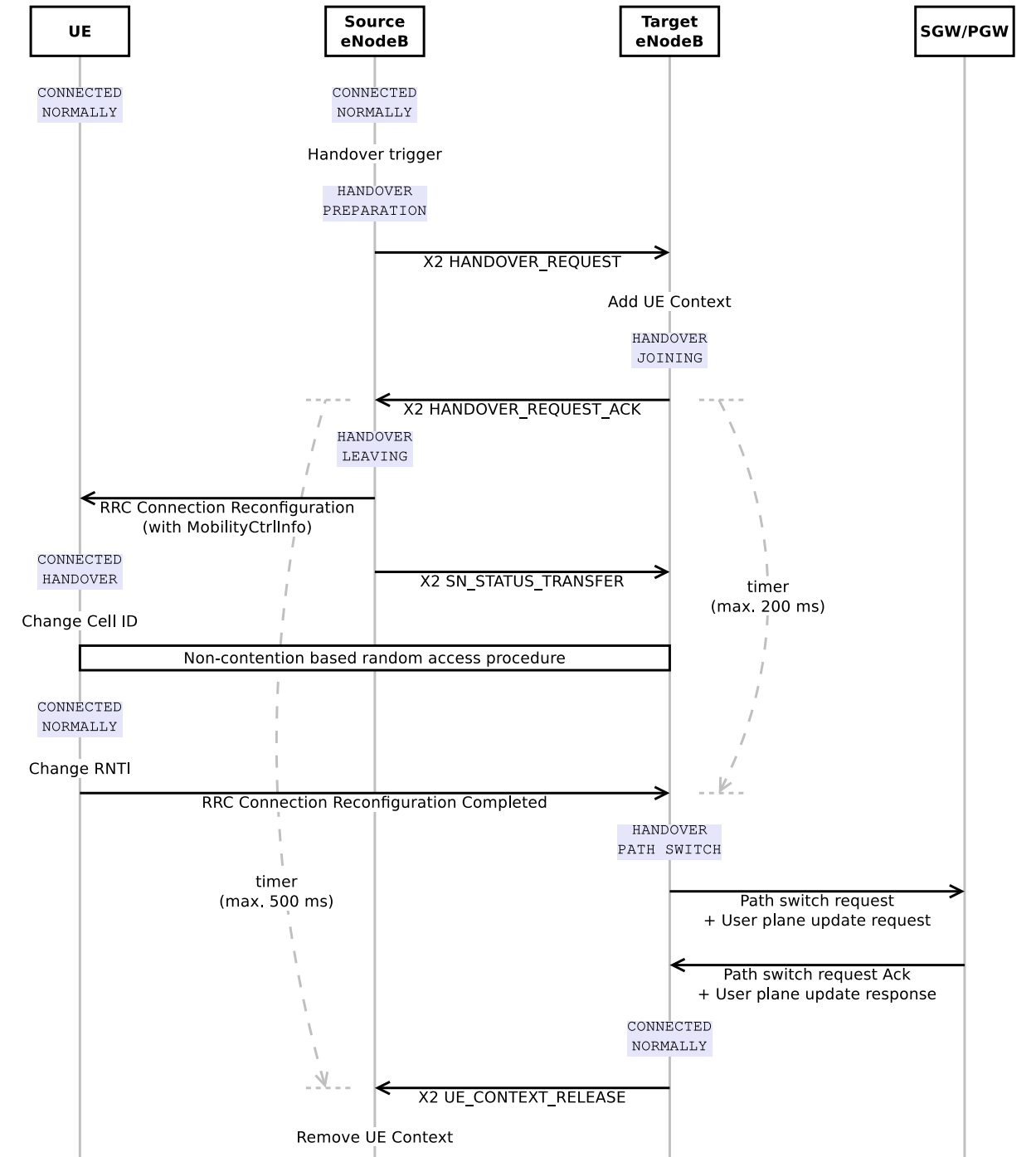

Fig. 45: Sequence diagram of the X2-based handover

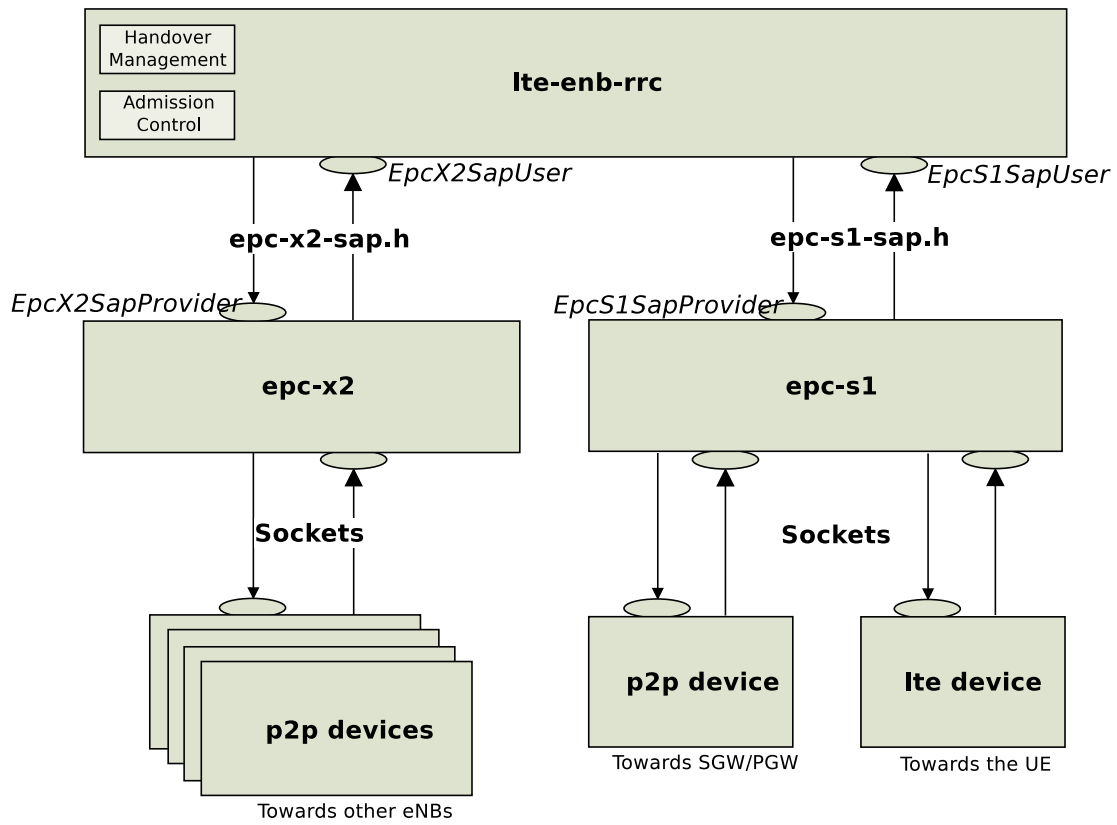

Fig. 46: Implementation Model of X2 entity and SAPs

The RRC entity manages the initiation of the handover procedure. This is done in the Handover Management submodule of the eNB RRC entity. The target eNB may perform some Admission Control procedures. This is done in the Admission Control submodule. Initially, this submodule will accept any handover request.

## X2 interfaces

The X2 model contains two interfaces:

- the X2-C interface. It is the control interface and it is used to send the X2-AP PDUs (i.e. the elementary procedures).
- the X2-U interface. It is used to send the bearer data when there is *DL forwarding*.

Figure *X2 interface protocol stacks* shows the protocol stacks of the X2-U interface and X2-C interface modeled in the simulator.

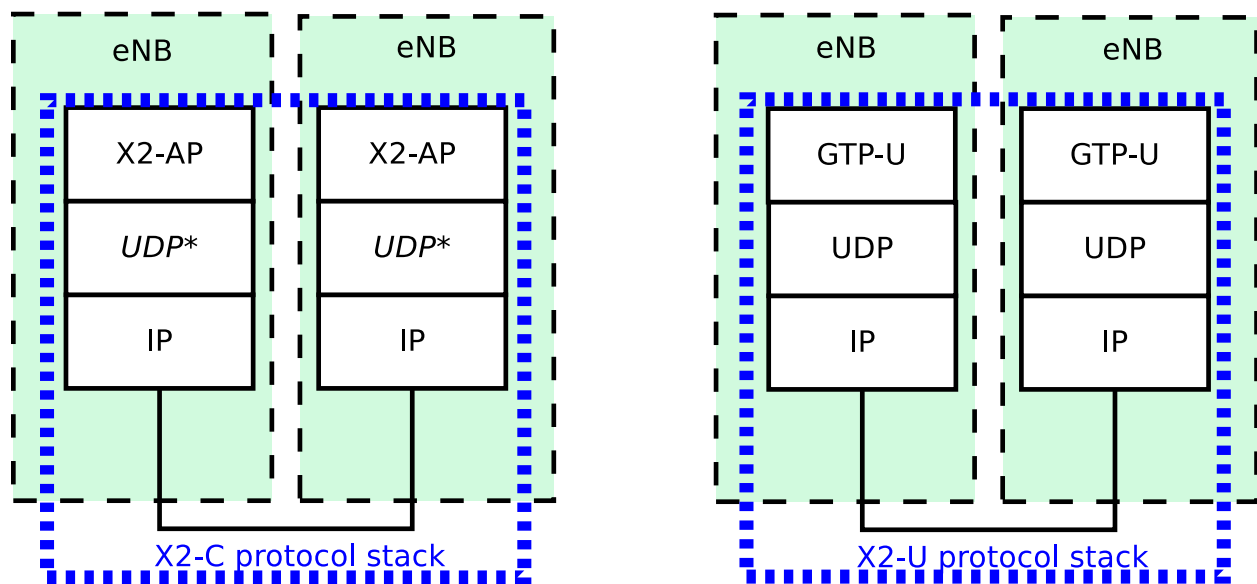

Fig. 47: X2 interface protocol stacks

## X2-C

The X2-C interface is the control part of the X2 interface and it is used to send the X2-AP PDUs (i.e. the elementary procedures).

In the original X2 interface control plane protocol stack, SCTP is used as the transport protocol but currently, the SCTP protocol is not modeled in the ns-3 simulator and its implementation is out-of-scope of the project. The UDP protocol is used as the datagram oriented protocol instead of the SCTP protocol.

## X2-U

The X2-U interface is used to send the bearer data when there is *DL forwarding* during the execution of the X2-based handover procedure. Similarly to what done for the S1-U interface, data packets are encapsulated over GTP/UDP/IP when being sent over this interface. Note that the EPS Bearer QoS is not enforced on the X2-U links, it is assumed that the overprovisioning of the link bandwidth is sufficient to meet the QoS requirements of all bearers.

## X2 Service Interface

The X2 service interface is used by the RRC entity to send and receive messages of the X2 procedures. It is divided into two parts:

- the `EpcX2SapProvider` part is provided by the X2 entity and used by the RRC entity and
- the `EpcX2SapUser` part is provided by the RRC entity and used by the RRC entity.

The primitives that are supported in our X2-C model are described in the following subsections.

### X2-C primitives for handover execution

The following primitives are used for the X2-based handover:

- HANDOVER REQUEST
- HANDOVER REQUEST ACK
- HANDOVER PREPARATION FAILURE
- SN STATUS STRANSFER
- UE CONTEXT RELEASE

all the above primitives are used by the currently implemented RRC model during the preparation and execution of the handover procedure. Their usage interacts with the RRC state machine; therefore, they are not meant to be used for code customization, at least unless it is desired to modify the RRC state machine.

### X2-C SON primitives

The following primitives can be used to implement Self-Organized Network (SON) functionalities:

- LOAD INFORMATION
- RESOURCE STATUS UPDATE

note that the current RRC model does not actually use these primitives, they are included in the model just to make it possible to develop SON algorithms included in the RRC logic that make use of them.

As a first example, we show here how the load information primitive can be used. We assume that the `LteEnbRrc` has been modified to include the following new member variables:

```
std::vector<EpcX2Sap::UlInterferenceOverloadIndicationItem>
    m_currentUlInterferenceOverloadIndicationList;
std::vector<EpcX2Sap::UlHighInterferenceInformationItem>
    m_currentUlHighInterferenceInformationList;
EpcX2Sap::RelativeNarrowbandTxBand m_currentRelativeNarrowbandTxBand;
```

for a detailed description of the type of these variables, we suggest to consult the file `epc-x2-sap.h`, the corresponding doxygen documentation, and the references therein to the relevant sections of 3GPP TS 36.423. Now, assume that at run time these variables have been set to meaningful values following the specifications just mentioned. Then, you can add the following code in the `LteEnbRrc` class implementation in order to send a load information primitive:

```
EpcX2Sap::CellInformationItem cii;
cii.sourceCellId = m_cellId;
cii.ulInterferenceOverloadIndicationList = m_
↪currentUlInterferenceOverloadIndicationList;
cii.ulHighInterferenceInformationList = m_currentUlHighInterferenceInformationList;
```

(continues on next page)

(continued from previous page)

```
cii.relativeNarrowbandTxBand = m_currentRelativeNarrowbandTxBand;

EpcX2Sap::LoadInformationParams params;
params.targetCellId = cellId;
params.cellInformationList.push_back (cii);
m_x2SapProvider->SendLoadInformation (params);
```

The above code allows the source eNB to send the message. The method `LteEnbRrc::DoRecvLoadInformation` will be called when the target eNB receives the message. The desired processing of the load information should therefore be implemented within that method.

In the following second example we show how the resource status update primitive is used. We assume that the `LteEnbRrc` has been modified to include the following new member variable:

```
EpcX2Sap::CellMeasurementResultItem m_cmri;
```

similarly to before, we refer to `epc-x2-sap.h` and the references therein for detailed information about this variable type. Again, we assume that the variable has been already set to a meaningful value. Then, you can add the following code in order to send a resource status update:

```
EpcX2Sap::ResourceStatusUpdateParams params;
params.targetCellId = cellId;
params.cellMeasurementResultList.push_back (m_cmri);
m_x2SapProvider->SendResourceStatusUpdate (params);
```

The method `eEnbRrc::DoRecvResourceStatusUpdate` will be called when the target eNB receives the resource status update message. The desired processing of this message should therefore be implemented within that method.

Finally, we note that the setting and processing of the appropriate values for the variable passed to the above described primitives is deemed to be specific of the SON algorithm being implemented, and hence is not covered by this documentation.

## Unsupported primitives

Mobility Robustness Optimization primitives such as Radio Link Failure indication and Handover Report are not supported at this stage.



### 19.1.14 S11

The S11 interface provides control plane interaction between the SGW and the MME using the GTPv2-C protocol specified in [TS29274]. In the simulator, this interface is modeled in an ideal fashion, with direct interaction between the SGW and the MME objects, without actually implementing the encoding of the messages and without actually transmitting any PDU on any link.

The S11 primitives that are modeled are:

- CREATE SESSION REQUEST
- CREATE SESSION RESPONSE
- MODIFY BEARER REQUEST
- MODIFY BEARER RESPONSE

Of these primitives, the first two are used upon initial UE attachment for the establishment of the S1-U bearers; the other two are used during handover to switch the S1-U bearers from the source eNB to the target eNB as a consequence of the reception by the MME of a PATH SWITCH REQUEST S1-AP message.

## 19.1.15 Power Control

This section describes the ns-3 implementation of Downlink and Uplink Power Control.

### Downlink Power Control

Since some of Frequency Reuse Algorithms require Downlink Power Control, this feature was also implemented in ns-3.

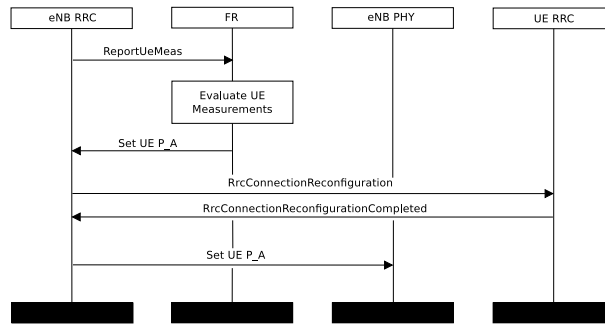

Fig. 48: Sequence diagram of Downlink Power Control

Figure *Sequence diagram of Downlink Power Control* shows the sequence diagram of setting downlink P\_A value for UE, highlighting the interactions between the RRC and the other entities. FR algorithm triggers RRC to change P\_A values for UE. Then RRC starts RrcConnectionReconfiguration function to inform UE about new configuration. After successful RrcConnectionReconfiguration, RRC can set P\_A value for UE by calling function SetPa from CphySap, value is saved in new map m\_paMap which contain P\_A values for each UE served by eNB.

When LteEnbPhy starts new subframe, DCI control messages are processed to get vector of used RBs. Now also GeneratePowerAllocationMap(uint16\_t rnti, int rbId) function is also called. This function check P\_A value for UE, generate power for each RB and store it in m\_dlPowerAllocationMap. Then this map is used by CreateTxPowerSpectralDensityWithPowerAllocation function to create Ptr<SpectrumValue> txPsd.

PdschConfigDedicated (TS 36.331, 6.3.2 PDSCH-Config) was added in LteRrcSap::PhysicalConfigDedicated struct, which is used in RrcConnectionReconfiguration process.

### Uplink Power Control

Uplink power control controls the transmit power of the different uplink physical channels. This functionality is described in 3GPP TS 36.213 section 5.

Uplink Power Control is enabled by default, and can be disabled by attribute system:

```
Config::SetDefault ("ns3::LteUePhy::EnableUplinkPowerControl", BooleanValue (false));
```

Two Uplink Power Control mechanisms are implemented:

- Open Loop Uplink Power Control: the UE transmission power depends on estimation of the downlink path-loss and channel configuration
- Closed Loop Uplink Power Control: as in Open Loop, in addition eNB can control the UE transmission power by means of explicit Transmit Power Control TPC commands transmitted in the downlink.

To switch between these two mechanism types, one should change parameter:

```
Config::SetDefault ("ns3::LteUePowerControl::ClosedLoop", BooleanValue (true));
```

By default, Closed Loop Power Control is enabled.

### Two modes of Closed Loop Uplink Power Control are available:

- Absolute mode: TxPower is computed with absolute TPC values
- Accumulative mode: TxPower is computed with accumulated TPC values

To switch between these two modes, one should change parameter:

```
Config::SetDefault ("ns3::LteUePowerControl::AccumulationEnabled", BooleanValue_
↪(true));
```

By default, Accumulation Mode is enabled and TPC commands in DL-DCI are set by all schedulers to 1, what is mapped to value of 0 in Accumulation Mode.

### Uplink Power Control for PUSCH

The setting of the UE Transmit power for a Physical Uplink Shared Channel (PUSCH) transmission is defined as follows:

- If the UE transmits PUSCH without a simultaneous PUCCH for the serving cell  $c$ , then the UE transmit power  $P_{PUSCH,c}(i)$  for PUSCH transmission in subframe  $i$  for the serving cell  $c$  is given by:

$$P_{PUSCH,c}(i) = \min \left\{ \begin{array}{l} P_{CMAX,c}(i) \\ 10 \log_{10}(M_{PUSCH,c}(i)) + P_{O\_PUSCH,c}(j) + \alpha_c(j) * PL_c + \Delta_{TF,c}(i) + f_c(i) \end{array} \right\} [dBm]$$

- If the UE transmits PUSCH simultaneous with PUCCH for the serving cell  $c$ , then the UE transmit power  $P_{PUSCH,c}(i)$  for the PUSCH transmission in subframe  $i$  for the serving cell  $c$  is given by:

$$P_{PUSCH,c}(i) = \min \left\{ \begin{array}{l} 10 \log_{10}(\hat{P}_{CMAX,c}(i) - \hat{P}_{PUCCH}(i)) \\ 10 \log_{10}(M_{PUSCH,c}(i)) + P_{O\_PUSCH,c}(j) + \alpha_c(j) * PL_c + \Delta_{TF,c}(i) + f_c(i) \end{array} \right\} [dBm]$$

Since Uplink Power Control for PUCCH is not implemented, this case is not implemented as well.

- If the UE is not transmitting PUSCH for the serving cell  $c$ , for the accumulation of TPC command received with DCI format 3/3A for PUSCH, the UE shall assume that the UE transmit power  $P_{PUSCH,c}(i)$  for the PUSCH transmission in subframe  $i$  for the serving cell  $c$  is computed by

$$P_{PUSCH,c}(i) = \min \left\{ \begin{array}{l} P_{CMAX,c}(i) \\ P_{O\_PUSCH,c}(1) + \alpha_c(1) * PL_c + f_c(i) \end{array} \right\} [dBm]$$

where:

- $P_{CMAX,c}(i)$  is the configured UE transmit power defined in 3GPP 36.101. Table 6.2.2-1 in subframe  $i$  for serving cell  $c$  and  $\hat{P}_{CMAX,c}(i)$  is the linear value of  $P_{CMAX,c}(i)$ . Default value for  $P_{CMAX,c}(i)$  is 23 dBm
- $M_{PUSCH,c}(i)$  is the bandwidth of the PUSCH resource assignment expressed in number of resource blocks valid for subframe  $i$  and serving cell  $c$ .
- $P_{O\_PUSCH,c}(j)$  is a parameter composed of the sum of a component  $P_{O\_NOMINAL\_PUSCH,c}(j)$  provided from higher layers for  $j = 0, 1$  and a component  $P_{O\_UE\_PUSCH,c}(j)$  provided by higher layers for  $j = 0, 1$  for serving cell  $c$ . SIB2 message needs to be extended to carry these two components, but currently they can be set via attribute system:

```
Config::SetDefault ("ns3::LteUePowerControl::PoNominalPusch", IntegerValue (-
↪90));
Config::SetDefault ("ns3::LteUePowerControl::PoUePusch", IntegerValue (7));
```

- $\alpha_c(j)$  is a 3-bit parameter provided by higher layers for serving cell  $c$ . For  $j = 0, 1$ ,  $\alpha_c \in \{0, 0.4, 0.5, 0.6, 0.7, 0.8, 0.9, 1\}$  For  $j = 2$ ,  $\alpha_c(j) = 1$ . This parameter is configurable by attribute system:

```
Config::SetDefault ("ns3::LteUePowerControl::Alpha", DoubleValue (0.8));
```

- $PL_c$  is the downlink pathloss estimate calculated in the UE for serving cell  $c$  in dB and  $PL_c = referenceSignalPower \sim higherlayerfilteredRSRP$ , where  $referenceSignalPower$  is provided by higher layers and RSRP.  $referenceSignalPower$  is provided in SIB2 message
- $\Delta_{TF,c}(i) = 10 \log_{10}((2^{BPRE \cdot K_s} - 1) \cdot \beta_{offset}^{PUSCH})$  for  $K_s = 1.25$  and  $\Delta_{TF,c}(i) = 0$  for  $K_s = 0$ . Only second case is implemented.
- $f_c(i)$  is component of Closed Loop Power Control. It is the current PUSCH power control adjustment state for serving cell  $c$ .

If Accumulation Mode is enabled  $f_c(i)$  is given by:

$$f_c(i) = f_c(i-1) + \delta_{PUSCH,c}(i - K_{PUSCH})$$

where:  $\delta_{PUSCH,c}$  is a correction value, also referred to as a TPC command and is included in PDCCH with DCI;  $\delta_{PUSCH,c}(i - K_{PUSCH})$  was signalled on PDCCH/EPDCCH with DCI for serving cell  $c$  on subframe  $(i - K_{PUSCH})$ ;  $K_{PUSCH} = 4$  for FDD.

If UE has reached  $P_{CMAX,c}(i)$  for serving cell  $c$ , positive TPC commands for serving cell  $c$  are not be accumulated. If UE has reached minimum power, negative TPC commands are not be accumulated. Minimum UE power is defined in TS36.101 section 6.2.3. Default value is -40 dBm.

If Accumulation Mode is not enabled  $f_c(i)$  is given by:

$$f_c(i) = \delta_{PUSCH,c}(i - K_{PUSCH})$$

where:  $\delta_{PUSCH,c}$  is a correction value, also referred to as a TPC command and is included in PDCCH with DCI;  $\delta_{PUSCH,c}(i - K_{PUSCH})$  was signalled on PDCCH/EPDCCH with DCI for serving cell  $c$  on subframe  $(i - K_{PUSCH})$ ;  $K_{PUSCH} = 4$  for FDD.

Mapping of TPC Command Field in DCI format 0/3/4 to absolute and accumulated  $\delta_{PUSCH,c}$  values is defined in TS36.231 section 5.1.1.1 Table 5.1.1.1-2

## Uplink Power Control for PUCCH

Since all uplink control messages are an ideal messages and do not consume any radio resources, Uplink Power Control for PUCCH is not needed and it is not implemented.

## Uplink Power Control for SRS

The setting of the UE Transmit power  $P_{SRS}$  for the SRS transmitted on subframe  $i$  for serving cell  $c$  is defined by

$$P_{PUSCH,c}(i) = \min \left\{ P_{SRS\_OFFSET,c}(m) + 10 \log_{10}(M_{SRS,c}) + P_{O\_PUSCH,c}(j) + \alpha_c(j) * PL_c + f_c(i) \right\} [dBm]$$

where:

- $P_{CMAX,c}(i)$  is the configured UE transmit power defined in 3GPP 36.101. Table 6.2.2-1. Default value for  $P_{CMAX,c}(i)$  is 23 dBm
- $P_{SRS\_OFFSET,c}(m)$  is semi-statically configured by higher layers for  $m = 0, 1$  for serving cell  $c$ . For SRS transmission given trigger type 0 then  $m = 0, 1$  and for SRS transmission given trigger type 1 then  $m = 1$ . For  $K_s = 0$   $P_{Srs\_Offset\_Value}$  is computed with equation:

$$P_{SRS\_OFFSET,c}(m) \text{ value} = -10.5 + P_{SRS\_OFFSET,c}(m) * 1.5 [dBm]$$

This parameter is configurable by attribute system:

```
Config::SetDefault ("ns3::LteUePowerControl::PsrsOffset", IntegerValue (7));
```

- $M_{SRS,c}$  is the bandwidth of the SRS transmission in subframe  $i$  for serving cell  $c$  expressed in number of resource blocks. In current implementation SRS is sent over entire UL bandwidth.
- $f_c(i)$  is the current PUSCH power control adjustment state for serving cell  $c$ , as defined in *Uplink Power Control for PUSCH*
- $P_{O\_PUSCH,c}(j)$  and  $\alpha_c(j)$  are parameters as defined in *Uplink Power Control for PUSCH*, where  $j = 1$ .

## 19.1.16 Fractional Frequency Reuse

### Overview

This section describes the ns-3 support for Fractional Frequency Reuse algorithms. All implemented algorithms are described in [ASHamza2013]. Currently 7 FR algorithms are implemented:

- ns3::LteFrNoOpAlgorithm
- ns3::LteFrHardAlgorithm
- ns3::LteFrStrictAlgorithm
- ns3::LteFrSoftAlgorithm
- ns3::LteFfrSoftAlgorithm
- ns3::LteFfrEnhancedAlgorithm
- ns3::LteFfrDistributedAlgorithm

New LteFfrAlgorithm class was created and it is a abstract class for Frequency Reuse algorithms implementation. Also, two new SAPs between FR-Scheduler and FR-RRC were added.

Figure *Sequence diagram of Scheduling with FR algorithm* shows the sequence diagram of scheduling process with FR algorithm. In the beginning of scheduling process, scheduler asks FR entity for available RBGs. According to implementation FR returns all RBGs available in cell or filter them based on its policy. Then when trying to assign some RBG to UE, scheduler asks FR entity if this RBG is allowed for this UE. When FR returns true, scheduler can assign this RBG to this UE, if not scheduler is checking another RBG for this UE. Again, FR response depends on implementation and policy applied to UE.

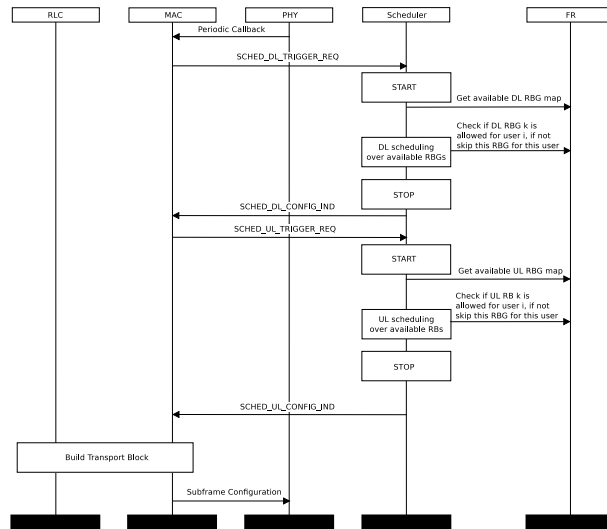

Fig. 49: Sequence diagram of Scheduling with FR algorithm

## Supported FR algorithms

### No Frequency Reuse

The NoOp FR algorithm (`LteFrNoOpAlgorithm` class) is implementation of Full Frequency Reuse scheme, that means no frequency partitioning is performed between eNBs of the same network (frequency reuse factor, FRF equals 1). eNBs uses entire system bandwidth and transmit with uniform power over all RBGs. It is the simplest scheme and is the basic way of operating an LTE network. This scheme allows for achieving the high peak data rate. But from the other hand, due to heavy interference levels from neighbouring cells, cell-edge users performance is greatly limited.

Figure *Full Frequency Reuse scheme* below presents frequency and power plan for Full Frequency Reuse scheme.

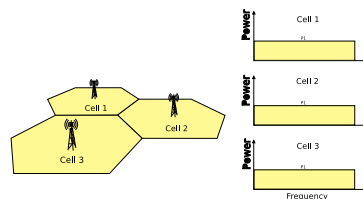

Fig. 50: Full Frequency Reuse scheme

In ns-3, the NoOp FR algorithm always allows scheduler to use full bandwidth and allows all UEs to use any RBG. It simply does nothing new (i.e. it does not limit eNB bandwidth, FR algorithm is disabled), it is the simplest implementation of `FrAlgorithm` class and is installed in eNB by default.

### Hard Frequency Reuse

The Hard Frequency Reuse algorithm provides the simplest scheme which allows to reduce inter-cell interference level. In this scheme whole frequency bandwidth is divided into few (typically 3, 4, or 7) disjoint sub-bands. Adjacent eNBs are allocated with different sub-band. Frequency reuse factor equals the number of sub-bands. This scheme allows to significantly reduce ICI at the cell edge, so the performance of cell-users is improved. But due to the fact, that each eNB uses only one part of whole bandwidth, peak data rate level is also reduced by the factor equal to the reuse factor.

Figure *Hard Frequency Reuse scheme* below presents frequency and power plan for Hard Frequency Reuse scheme.

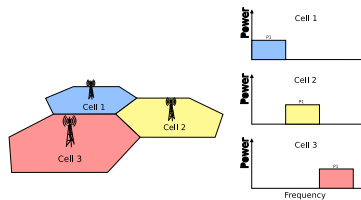

Fig. 51: Hard Frequency Reuse scheme

In our implementation, the Hard FR algorithm has only vector of RBGs available for eNB and pass it to MAC Scheduler during scheduling functions. When scheduler ask, if RBG is allowed for specific UE it always return true.

### Strict Frequency Reuse

Strict Frequency Reuse scheme is combination of Full and Hard Frequency Reuse schemes. It consists of dividing the system bandwidth into two parts which will have different frequency reuse. One common sub-band of the system bandwidth is used in each cell interior (frequency reuse-1), while the other part of the bandwidth is divided among the neighboring eNBs as in hard frequency reuse (frequency reuse- $N$ ,  $N > 1$ ), in order to create one sub-band with a low inter-cell interference level in each sector. Center UEs will be granted with the fully-reused frequency chunks, while cell-edge UEs with orthogonal chunks. It means that interior UEs from one cell do not share any spectrum with edge UEs from second cell, which reduces interference for both. As can be noticed, Strict FR requires a total of  $N + 1$  sub-bands, and allows to achieve RFR in the middle between 1 and 3.

Figure *Strict Frequency Reuse scheme* below presents frequency and power plan for Strict Frequency Reuse scheme with a cell-edge reuse factor of  $N = 3$ .

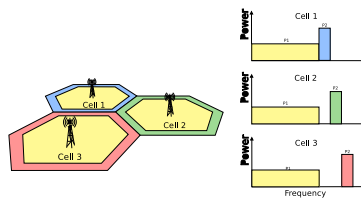

Fig. 52: Strict Frequency Reuse scheme

In our implementation, Strict FR algorithm has two maps, one for each sub-band. If UE can be served within private sub-band, its RNTI is added to `m_privateSubBandUe` map. If UE can be served within common sub-band, its RNTI is added to `m_commonSubBandUe` map. Strict FR algorithm needs to decide within which sub-band UE should be served. It uses UE measurements provided by RRB and compare them with signal quality threshold (this parameter can be easily tuned by attribute mechanism). Threshold has influence on interior to cell radius ratio.

### Soft Frequency Reuse

In Soft Frequency Reuse (SFR) scheme each eNB transmits over the entire system bandwidth, but there are two sub-bands, within UEs are served with different power level. Since cell-center UEs share the bandwidth with neighboring cells, they usually transmit at lower power level than the cell-edge UEs. SFR is more bandwidth efficient than Strict FR, because it uses entire system bandwidth, but it also results in more interference to both cell interior and edge users.

There are two possible versions of SFR scheme:

- In first version, the sub-band dedicated for the cell-edge UEs may also be used by the cell-center UEs but with reduced power level and only if it is not occupied by the cell-edge UEs. Cell-center sub-band is available to the

centre UEs only. Figure *Soft Frequency Reuse scheme version 1* below presents frequency and power plan for this version of Soft Frequency Reuse scheme.

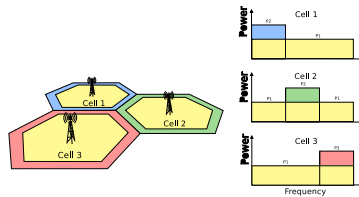

Fig. 53: Soft Frequency Reuse scheme version 1

- In second version, cell-center UEs do not have access to cell-edge sub-band. In this way, each cell can use the whole system bandwidth while reducing the interference to the neighbors cells. From the other hand, lower ICI level at the cell-edge is achieved at the expense of lower spectrum utilization. Figure *Soft Frequency Reuse scheme version 2* below presents frequency and power plan for this version of Soft Frequency Reuse scheme.

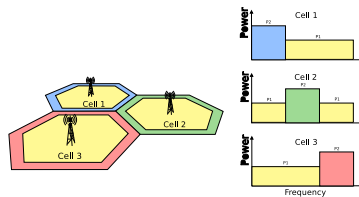

Fig. 54: Soft Frequency Reuse scheme version 2

SFR algorithm maintain two maps. If UE should be served with lower power level, its RNTI is added to `m_lowPowerSubBandUe` map. If UE should be served with higher power level, its RNTI is added to `m_highPowerSubBandUe` map. To decide with which power level UE should be served SFR algorithm utilize UE measurements, and compares them to threshold. Signal quality threshold and `PdschConfigDedicated` (i.e. `P_A` value) for inner and outer area can be configured by attributes system. SFR utilizes Downlink Power Control described here.

### Soft Fractional Frequency Reuse

Soft Fractional Frequency Reuse (SFFR) is an combination of Strict and Soft Frequency Reuse schemes. While Strict FR do not use the subbands allocated for outer region in the adjacent cells, soft FFR uses these subbands for the inner UEs with low transmit power. As a result, the SFFR, like SFR, use the subband with high transmit power level and with low transmit power level. Unlike the Soft FR and like Strict FR, the Soft FFR uses the common sub-band which can enhance the throughput of the inner users.

Figure *Soft Fractional Fractional Frequency Reuse scheme* below presents frequency and power plan for Soft Fractional Frequency Reuse.

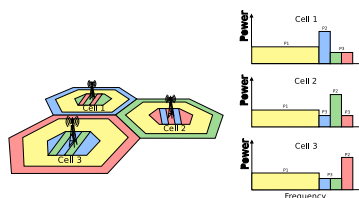

Fig. 55: Soft Fractional Fractional Frequency Reuse scheme



## Enhanced Fractional Frequency Reuse

Enhanced Fractional Frequency Reuse (EFFR) described in [ZXie2009] defines 3 cell-types for directly neighboring cells in a cellular system, and reserves for each cell-type a part of the whole frequency band named *Primary Segment*, which among different type cells should be orthogonal. The remaining subchannels constitute the *Secondary Segment*. The *Primary Segment* of a cell-type is at the same time a part of the *Secondary Segments* belonging to the other two cell-types. Each cell can occupy all subchannels of its *Primary Segment* at will, whereas only a part of subchannels in the *Secondary Segment* can be used by this cell in an interference-aware manner. The *Primary Segment* of each cell is divided into a reuse-3 part and reuse-1 part. The reuse-1 part can be reused by all types of cells in the system, whereas reuse-3 part can only be exclusively reused by other same type cells( i.e. the reuse-3 subchannels cannot be reused by directly neighboring cells). On the *Secondary Segment* cell acts as a guest, and occupying secondary subchannels is actually reuse the primary subchannels belonging to the directly neighboring cells, thus reuse on the *Secondary Segment* by each cell should conform to two rules:

- monitor before use
- resource reuse based on SINR estimation

Each cell listens on every secondary subchannel all the time. And before occupation, it makes SINR evaluation according to the gathered channel quality information (CQI) and chooses resources with best estimation values for reuse. If CQI value for RBG is above configured threshold for some user, transmission for this user can be performed using this RBG.

In [ZXie2009] scheduling process is described, it consist of three steps and two scheduling polices. Since none of currently implemented schedulers allow for this behaviour, some simplification were applied. In our implementation reuse-1 subchannels can be used only by cell center users. Reuse-3 subchannels can be used by edge users, and only if there is no edge user, transmission for cell center users can be served in reuse-3 subchannels.

Figure *Enhanced Fractional Fractional Frequency Reuse scheme* below presents frequency and power plan for Enhanced Fractional Frequency Reuse.

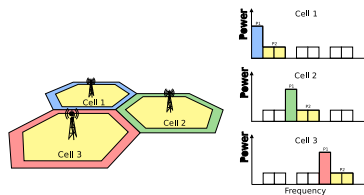

Fig. 56: Enhanced Fractional Fractional Frequency Reuse scheme

## Distributed Fractional Frequency Reuse

This Distributed Fractional Frequency Reuse Algorithm was presented in [DKimura2012]. It automatically optimizes cell-edge sub-bands by focusing on user distribution (in particular, receive-power distribution). This algorithm adaptively selects RBs for cell-edge sub-band on basis of coordination information from adjacent cells and notifies the base stations of the adjacent cells, which RBs it selected to use in edge sub-band. The base station of each cell uses the received information and the following equation to compute cell-edge-band metric  $A_k$  for each RB.

$$A_k = \sum_{j \in J} w_j X_{j,k}$$

where  $J$  is a set of neighbor cells,  $X_{j,k} = \{0, 1\}$  is the RNTP from the  $j$ -th neighbor cell. It takes a value of 1 when the  $k$ -th RB in the  $j$ -th neighbor cell is used as a cell-edge sub-band and 0 otherwise. The symbol  $w_j$  denotes weight with respect to adjacent cell  $j$ , that is, the number of users for which the difference between the power of the signal received from the serving cell  $i$  and the power of the signal received from the adjacent cell  $j$  is less than a threshold

value (i.e., the number of users near the cell edge in the service cell). A large received power difference means that cell-edge users in the  $i$ -th cell suffer strong interference from the  $j$ -th cell.

The RB for which metric  $A_k$  is smallest is considered to be least affected by interference from another cell. Serving cell selects a configured number of RBs as cell-edge sub-band in ascending order of  $A_k$ . As a result, the RBs in which a small number of cell-edge users receive high interference from adjacent base stations are selected.

The updated RNTP is then sent to all the neighbor cells. In order to avoid the meaningless oscillation of cell-edge-band selection, a base station ignores an RNTP from another base station that has larger cell ID than the base station.

Repeating this process across all cells enables the allocation of RBs to cell-edge areas to be optimized over the system and to be adjusted with changes in user distribution.

Figure *Sequence diagram of Distributed Frequency Reuse Scheme* below presents sequence diagram of Distributed Fractional Frequency Reuse Scheme.

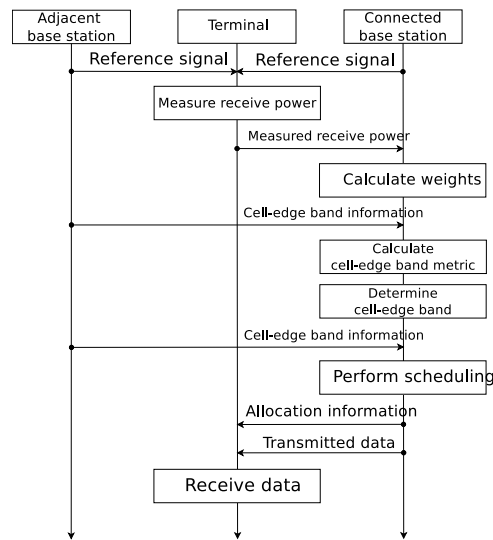

Fig. 57: Sequence diagram of Distributed Frequency Reuse Scheme

## 19.1.17 Carrier Aggregation

### Overview

This section describes the ns-3 support for Carrier Aggregation. The references in the standard are [TS36211], [TS36213] and [TS36331].

**Note:** Carrier Aggregation was introduced in release 3.27 and currently, only works in downlink.

3GPP standardizes, in release R10, the Carrier Aggregation (CA) technology.

This technology consists of the possibility, to aggregate radio resources belonging to different carriers, in order to have more bandwidth available, and to achieve a higher throughput. Carrier Aggregation as defined by 3GPP can be used with both TDD and FDD. Since ns-3 only supports FDD LTE implementation, we will consider only this case in this section. Each aggregated carrier is referred to as a component carrier, CC. The component carrier can have a bandwidth of 1.4, 3, 5, 10, 15 or 20 MHz and a maximum of five component carriers can be aggregated, hence the maximum aggregated bandwidth is 100 MHz. In FDD the number of aggregated carriers can be different in DL and UL. However, the number of UL component carriers is always equal to or lower than the number of DL component carriers. The individual component carriers can also be of different bandwidths. When carrier aggregation is used there are a number of serving cells, one for each component carrier. The coverage of the serving cells may differ, for example due to that CCs on different frequency bands will experience different pathloss. The RRC connection is only handled by one cell, the Primary serving cell, served by the Primary component carrier (DL and UL PCC). It is also on the DL PCC that the UE receives NAS information, such as security parameters.

3GPP defines three different CA bandwidth classes in releases 10 and 11 (where ATBC is Aggregated Transmission Bandwidth Configuration):

Class A:  $ATBC \leq 100$ , maximum number of CC = 1

Class B:  $ATBC \leq 100$ , maximum number of CC = 2

Class C:  $100 \leq ATBC \leq 200$ , maximum number of CC = 2

Figure *CA impact on different layers of LTE protocol stack (from 3gpp.org)* (from 3gpp.org) shows the main impact of CA technology on the different layers of the LTE protocol stack. Introduction of carrier aggregation influences mainly the MAC and new RRC messages are introduced. In order to keep R8/R9 compatibility the protocol changes will be kept to a minimum. Basically each component carrier is treated as an R8 carrier. However some changes are required, such as new RRC messages in order to handle the secondary component carrier (SCC), and MAC must be able to handle scheduling on a number of CCs. In the following we describe the impact of the carrier aggregation implementation on the different layers of the LTE protocol stack in ns-3.

### Impact on RRC layer

The main impacts on the RRC layer are related to secondary carrier configuration and measurements reporting. To enable these features we have enhanced the already existing procedures for the RRC Connection Reconfiguration and UE RRC Measurements Model.

The carrier aggregation enabling procedure is shown in figure *A schematic overview of the secondary carrier enabling procedure*. As per 3GPP definition, the secondary cell is a cell, operating on a secondary frequency, which may be configured once an RRC connection is established and which may be used to provide additional radio resources. Hence, the procedure starts when the UE is in the CONNECTED\_NORMALLY state (see the RRC state machine description). This part of the procedure is the same as in the previous architecture. In order to simplify the implementation, the *UE Capability Inquiry* and *UE Capability Information* are not implemented. This implies to assume that each UE can support the carrier aggregation, and any specific configuration provided by the eNB to which is attached. The eNB RRC sends to the UE the secondary carrier configuration parameters through the RRC Connection Reconfiguration procedure. This procedure may be used for various purposes related to modifications of the RRC connection, e.g. to establish, modify or release RBs, to perform handover, to setup, modify or release

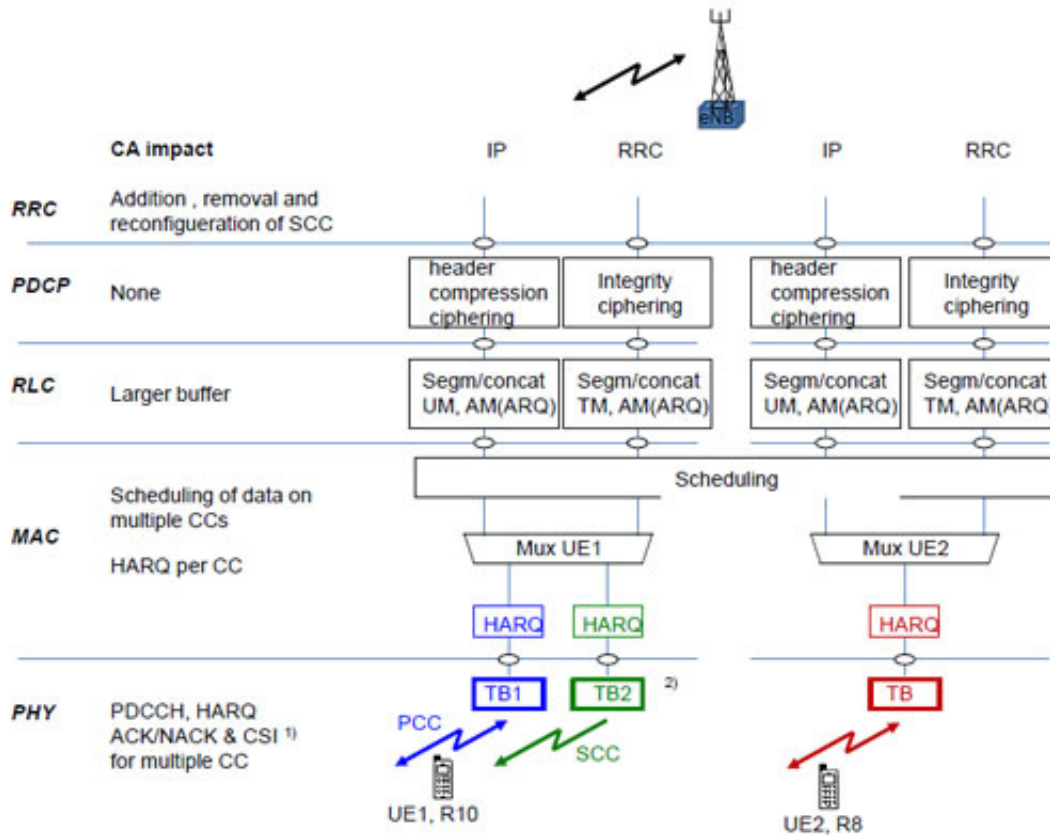

<sup>1)</sup> CSI = Channel State Information, provided on the UL by UE  
<sup>2)</sup> There will be 1 TB per CC, unless spatial multiplexing is used.

Fig. 58: CA impact on different layers of LTE protocol stack (from 3gpp.org)

measurements, to add, modify and release secondary cells (SCells). At UE side, the RRC is extended to configure the lower layers, in such a way that the SCell(s) are considered. Once the carriers are configured, the *Reconfiguration Completed* message is sent back to the eNB RRC, informing the eNB RRC and CCM that the secondary carriers have been properly configured. The RRC layer at both the UE and the eNB sides is extended to allow measurement reporting for the secondary carriers. Finally, in order to allow the procedures for configuration and measurement reporting, the RRC is enhanced to support serialization and deserialization of RRC message structures that carry information related to the secondary carriers, e.g., if the `RRCConnectionReconfiguration` message includes `sCellToAddModList` structure, SCell addition or modification will be performed, or, if it contains `measConfig` the measurement reporting will be configured. To allow transmission of this information the following structures are implemented for the sCell: `RadioResourceConfigCommonSCell`, `RadioResourceConfigDedicatedSCell` and `PhysicalConfigDedicatedSCell` and `NonCriticalExtensionConfiguration`. `RadioResourceConfigCommonSCell` and `RadioResourceConfigDedicatedSCell` are used for SCell addition and modification (see TS 36.331, 5.3.10.3b). `PhysicalConfigDedicatedSCell` is used for physical channel reconfiguration (see TS 36.331, 5.3.10.6). Finally, `NonCriticalExtensionConfiguration` is used to carry information of `sCellToAddModList` and `sCellToReleaseList`, which is a modified structure comparing to TS 36.331, 6.6.2, according to which these are directly in the root of `RRCConnectionReconfiguration` message. Measurement reporting is extended with `measResultSCell` structure to include RSRP and RSRQ measurements for each configured SCell. However, the measurement report triggering event A6 (neighbour becomes offset better than SCell) is not implemented yet.

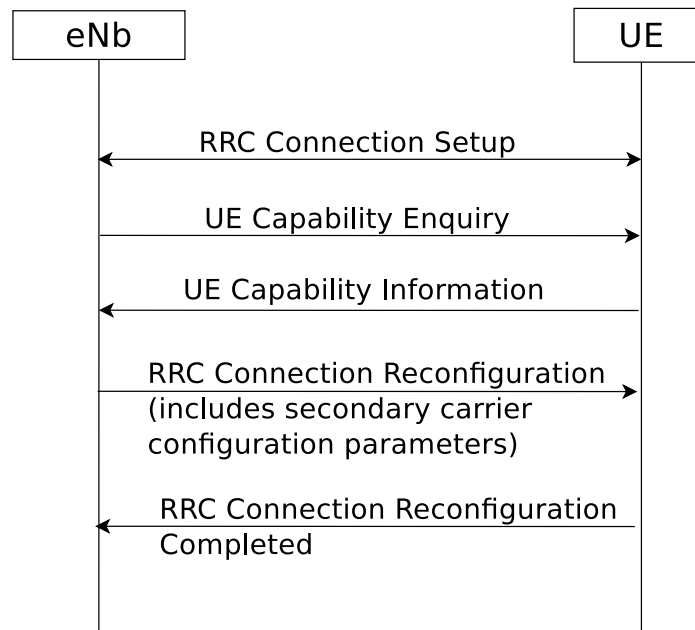

Fig. 59: A schematic overview of the secondary carrier enabling procedure

### Impact on PDCP layer

There is no impact on PDCP layer.

### Impact on RLC layer

The impact on the RLC layer is relatively small. There is some impact on configuration of the buffer and the usage of SAP interfaces between RLC and MAC. Since the capacity of the lower layers increases with the carrier aggregation it is necessary to accordingly adjust the size of the RLC buffer. The impact on the implementation of the RLC layer

is very small thanks to the design choice that allows the CCM manager to serve the different RLC instances through the `LteMacSapProvider` interface. Thanks to this design choice, the RLC is using the same interface as in the earlier LTE module architecture, the `LteMacSapProvider`, but the actual SAP provider in the new architecture is the CCM (some class that inherits `LteEnbComponentCarrierManager`). The CCM acts as a proxy, it receives function calls that are meant for the MAC, and forwards them to the MAC of the different component carriers. Additionally, it uses the information of the UEs and the logical channels for its own functionalities.

### Impact on MAC layer

The impact on the MAC layer depends on the CA scheduling scheme in use. Two different scheduling schemes are proposed in R10 and are shown in figure *CA scheduling schemes (from 3gpp.org)*.

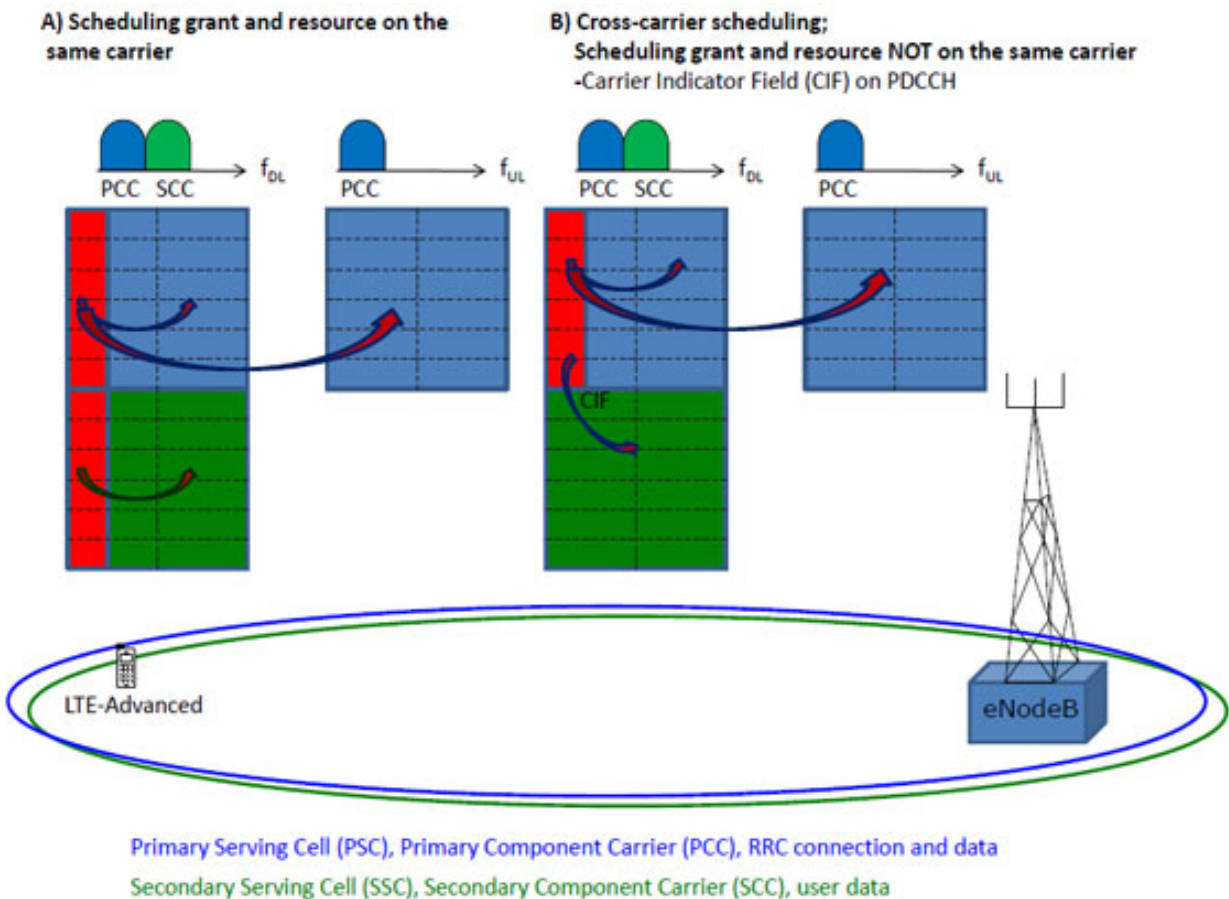

Fig. 60: CA scheduling schemes (from 3gpp.org)

The CIF (Carrier Indicator Field) on PDCCH (represented by the red area) indicates on which carrier the scheduled resource is located. In the following we describe both the schemes:

- scheduling grant and resources on the same carrier. One PDCCH is supported per carrier.
- cross-carrier scheduling: it is used to schedule resources on the secondary carrier without PDCCH.

Current implementation covers only option 1, so there is no cross-carrier scheduling. The MAC layer of the eNodeB has suffered minor changes and they are mainly related to addition of component carrier information in message exchange between layers.

## Impact on PHY layer

The impact on PHY layer is minor. There is an instance of PHY layer per each component carrier and the SAP interface functions remain unchanged. As shown in *CA scheduling schemes (from 3gpp.org)* the difference is that since there are multiple PHY instances, there are also multiple instances of PDCCH, HARQ, ACK/NACK and CSI per carrier. So, at the eNB PHY, the changes are related to the addition of the component carrier id information, while at the UE PHY the information of the Component Carrier is used for some functionalities that depend on the Component Carrier to which the PHY instance belongs. For example, the UE PHY is extended to allow disabling of the sounding reference signal (SRS) at the secondary carriers. This is necessary because there is one UE PHY instance per component carrier, but according to *CA scheduling schemes (from 3gpp.org)*, only a single carrier is used and the uplink traffic is transmitted only over the primary carrier.

## Code Structure Design

This section briefly introduces the software design and implementation of the carrier aggregation functionality.

Both `LteEnbNetDevice` and `LteUeNetDevice` are created by the `LteHelper` using the method `InstallSingleEnbDevice` and `InstallSingleUeDevice`. These functions are now extended to allow the carrier aggregation configuration. In the following we explain the main differences comparing to the previous architecture.

Figure *Changes in `LteEnbNetDevice` to support CA* shows the attributes and associations of the `LteEnbNetDevice` that are affected by the implementation, or are created in order to support the carrier aggregation functionality. Since `LteEnbNetDevice` may have several component carriers, the attributes that were formerly part of the `LteEnbNetDevice` and are carrier specific are migrated to the `ComponentCarrier` class, e.g. physical layer configuration parameters. The attributes that are specific for the eNB component carrier are migrated to `ComponentCarrierEnb`, e.g. pointers to MAC, PHY, scheduler, fractional frequency reuse instances. `LteEnbNetDevice` can contain pointers to several `ComponentCarrierEnb` instances. This architecture allows that each CC may have its own configuration for PHY, MAC, scheduling algorithm and fractional frequency reuse algorithm. These attributes are currently maintained also in the `LteEnbNetDevice` for backward compatibility purpose. By default the `LteEnbNetDevice` attributes are the same as the primary carrier attributes.

Figure *Changes in `LteUeNetDevice` to support CA* shows the attributes and associations of `LteUeNetDevice` that are affected by the carrier aggregation implementation. Similarly, to the changes in `LteEnbNetDevice`, pointers that are specific to UE component carrier are migrated to the `ComponentCarrierUe` class. `LteUeNetDevice` has maintained `m_dleArfcn` for initial cell selection purposes.

## CA impact on data plane of eNodeB

Figure *eNB Data Plane Architecture* shows the class diagram of the data plane at the eNB.

The main impact is the insertion of the `LteEnbComponentCarrierManager` class in the middle of the LTE protocol stack. During the design phase it was decided to keep the same SAP interfaces design that existed between MAC and RLC in order to avoid unnecessary changes in these parts of protocol stack. To achieve this the `LteEnbComponentCarrierManager` implements all functions that were previously exposed by RLC to MAC through `LteMacSapUser` interface. It also implements functions that were previously exposed by MAC to RLC through the `LteMacSapProvider` interface. In this way, the carrier aggregation is transparent to upper and lower layers. The only difference is that the MAC instance sees now only one `LteMacSapUser`, whereas formerly it was seeing only one `LteMacSapUser` per RLC instance.

The `LteEnbComponentCarrierManager` is responsible for the forwarding messages in both directions. In the current implementation, a PDCP and a RLC instances are activated each time a new data radio bearer is configured. The correspondence between a new data radio bearer and a RLC instance is one to one. In order to maintain the same

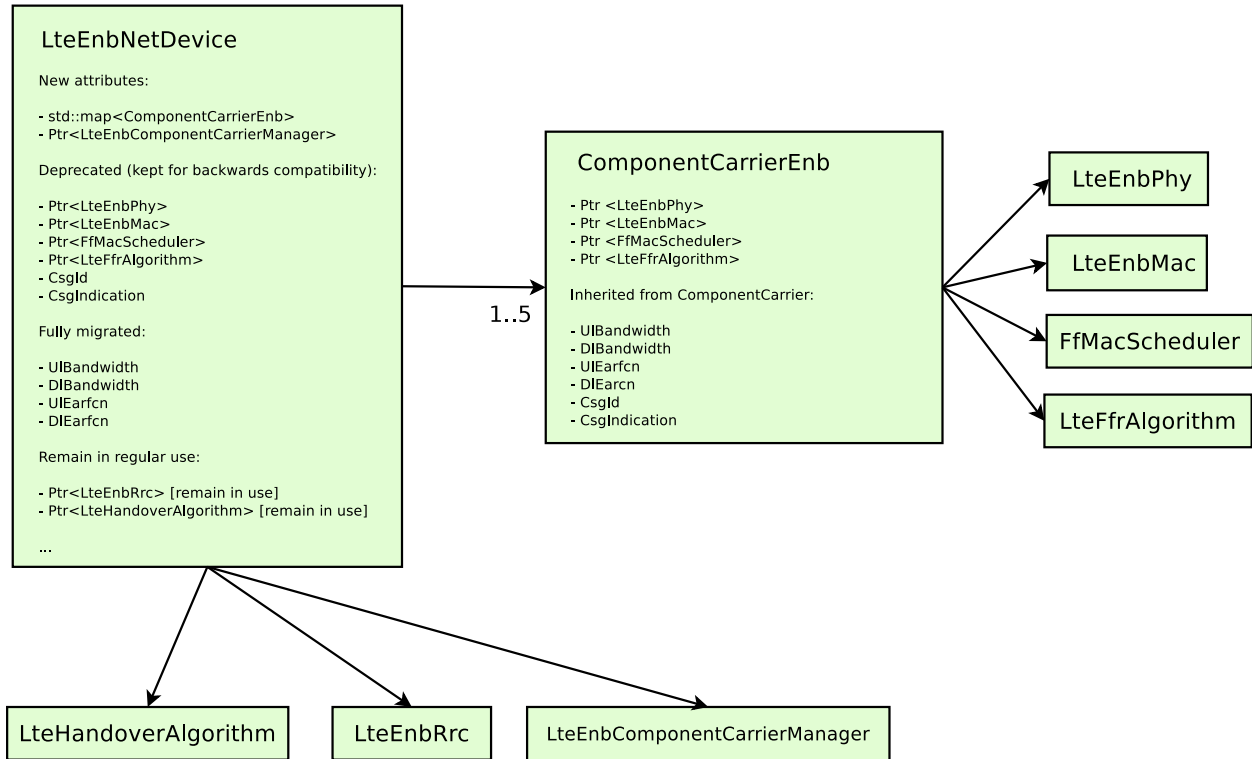

Fig. 61: Changes in LteEnbNetDevice to support CA

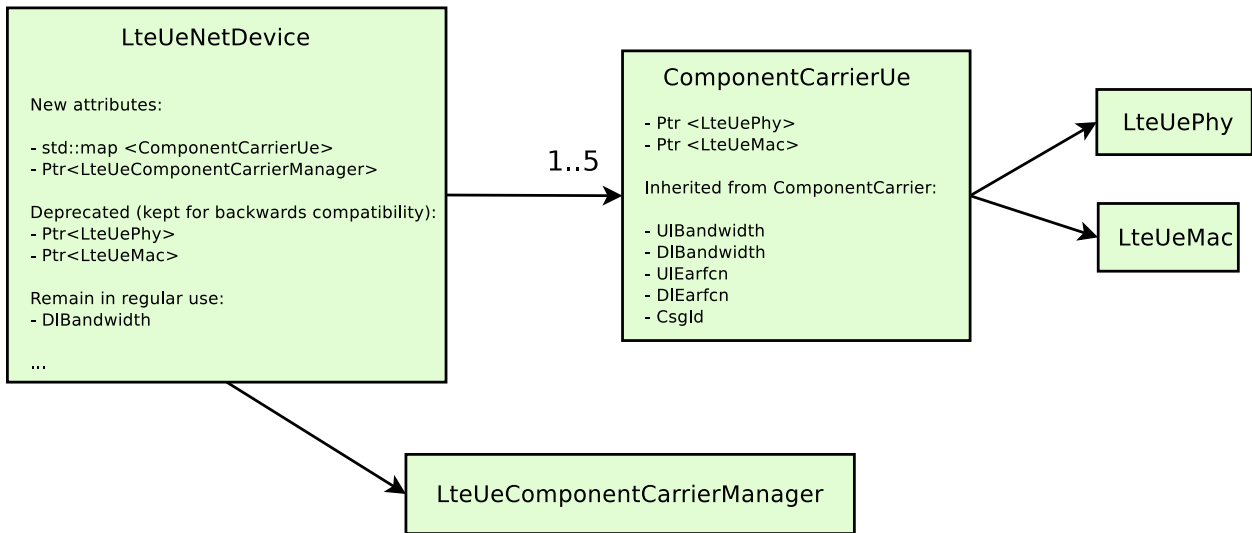

Fig. 62: Changes in LteUeNetDevice to support CA



behavior, when a new logical channel is activated, the logical channel configurations is propagated to each MAC layer object in “as is” fashion.

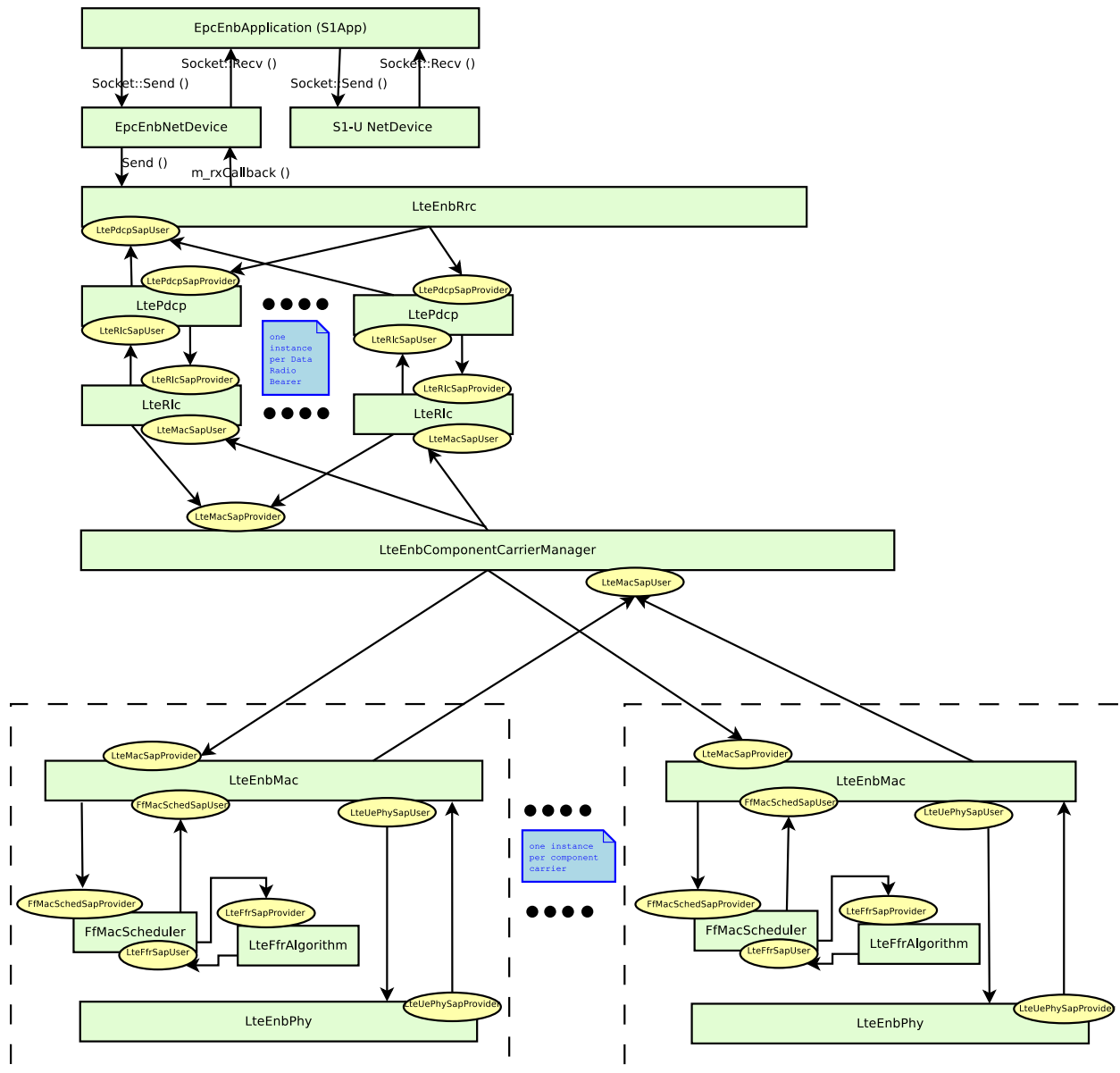

Fig. 63: eNB Data Plane Architecture

Figure *Sequence Diagram of downlink buffer status reporting (BSR) with CA* shows a sequence diagram of downlink buffer status reporting with a carrier aggregation implementation of only one secondary carrier. Each time that an RLC instance sends a buffer status report (BSR), the `LteEnbComponentCarrierManager` propagates the BSR to the MAC instances. The `LteEnbComponentCarrierManager` may modify a BSR before sending it to the MAC instances. This modification depends on the traffic split algorithm implemented in CCM class that inherits `LteEnbComponentCarrierManager`.

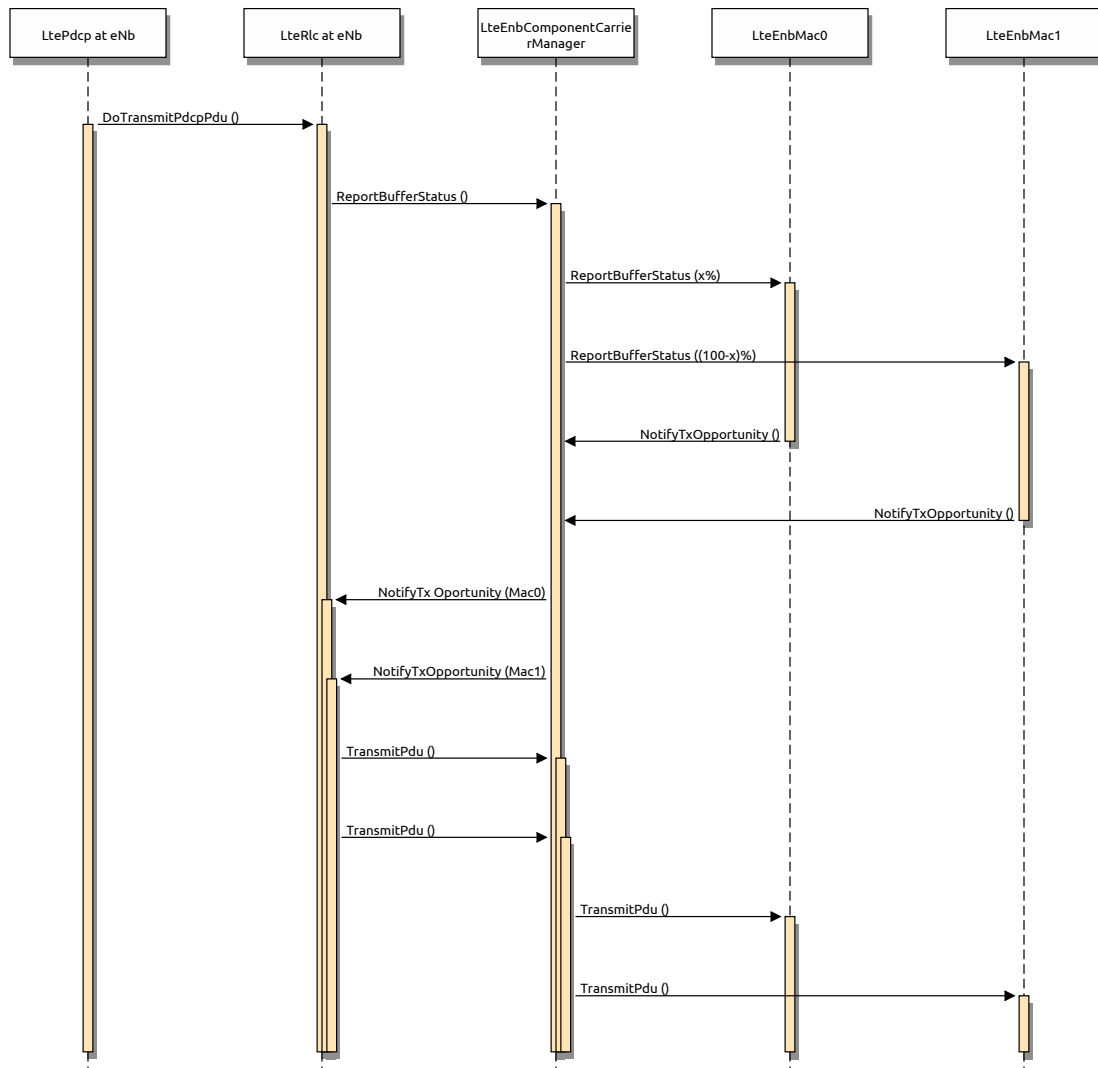

Fig. 64: Sequence Diagram of downlink buffer status reporting (BSR) with CA

## CA impact on control plane of eNodeB

Figure *eNB Control Plane Architecture* shows the class diagram of the control plane at the eNB. During the design phase it was decided to maintain the same hooks as in the former architecture. To do so, at each component carrier the PHY and the MAC are directly associated to the RRC instance. However, the RRC instance is additionally connected to the `LteEnbComponentCarrierManager`, which is responsible for enabling and disabling the component carriers. When the simulation starts, the number of component carrier is fixed, but only the primary carrier component is enabled. Depending on the `LteEnbComponentCarrierManager` algorithm the other carrier components could be activated or not.

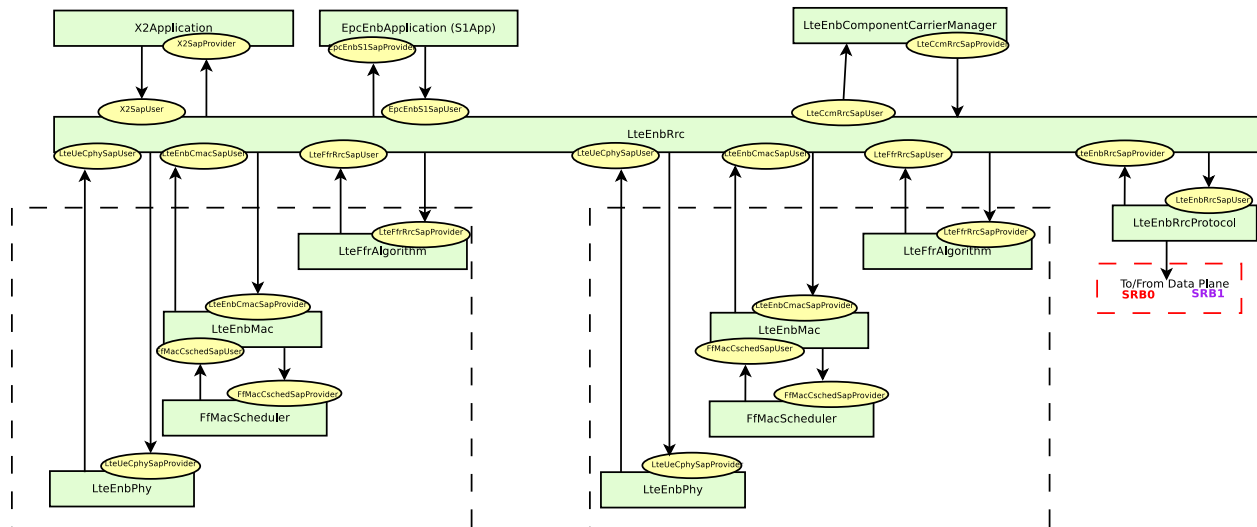

Fig. 65: eNB Control Plane Architecture

Figure *Sequence Diagram of Data Radio Bearer Setup* shows how the Radio Bearer are configured.

## CA impact on data plane of UE

Figure *UE Data Plane Architecture* shows the relation between the different classes related to the UE data plane. The UE data plane architecture is similar to the eNB data plane implementation. The `LteUeComponentCarrierManager` is responsible to (re)map each `MacSapUserProvider` to the corresponding RLC instance or to the proper MAC instance. The channel remapping depends on algorithm used as `LteUeComponentCarrierManager`. A particular case is represented by the UE buffer status report (BSR) to eNB. Since, i) the standard does not specify how the BSR has to be reported on each component carrier and ii) it is decided to map one-to-one the logical channel to each MAC layer, the only way to send BSRs to the eNB is through the primary carrier. Figure *Uplink buffer status reporting with CA* shows the sequence diagram. Each time a BSR is generated, the `LteUeComponentCarrierManager` sends it through the primary carrier component. When the primary component carrier at the eNB receives the BSR, it sends it to `LteEnbComponentCarrierManager`. The latter, according to algorithm dependent policies, forwards a BSR to component carriers. The communication between the `LteEnbMac` and the `LteEnbComponentCarrierManager` is done through a specific set of SAP functions which are implemented in the `LteUlCcmRrcSapUser` and the `LteUlCcmRrcSapProvider`.

## CA impact on control plane of UE

Figure *UE Control Plane Architecture* shows the relation between the different classes associated to the UE control plane. The control plane implementation at the UE is basically the same as the eNB control plane implementation.

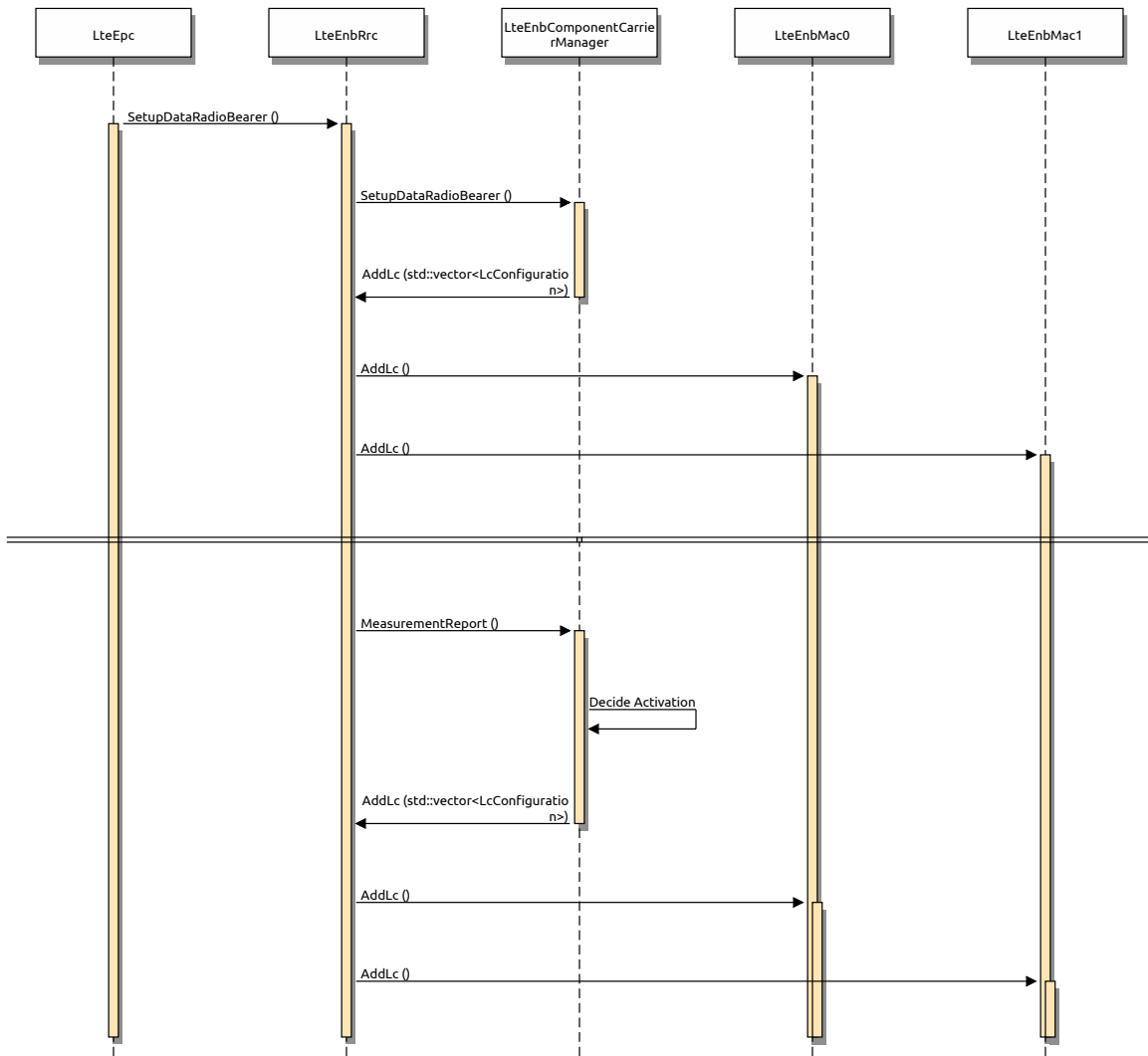

Fig. 66: Sequence Diagram of Data Radio Bearer Setup

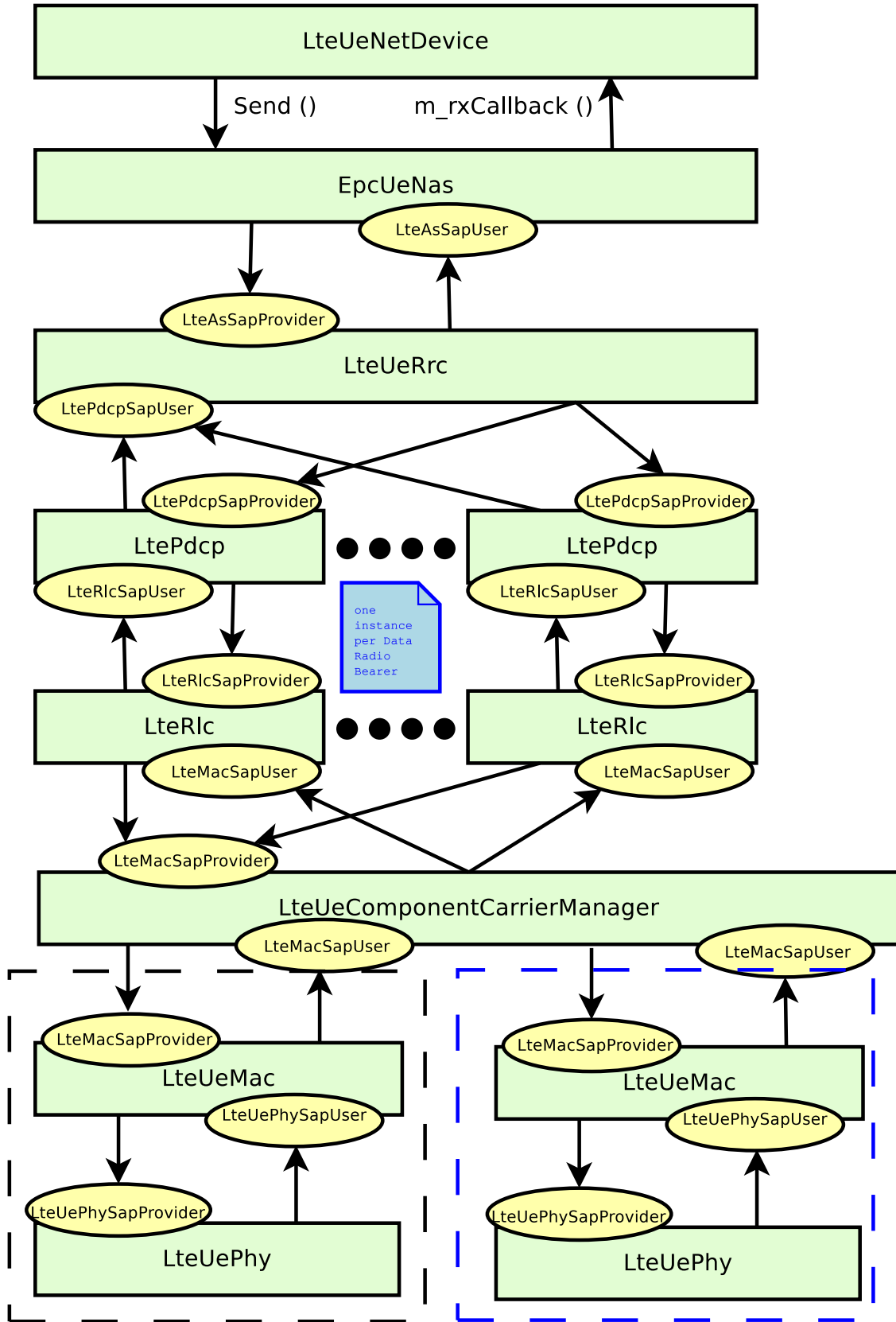

Fig. 67: UE Data Plane Architecture

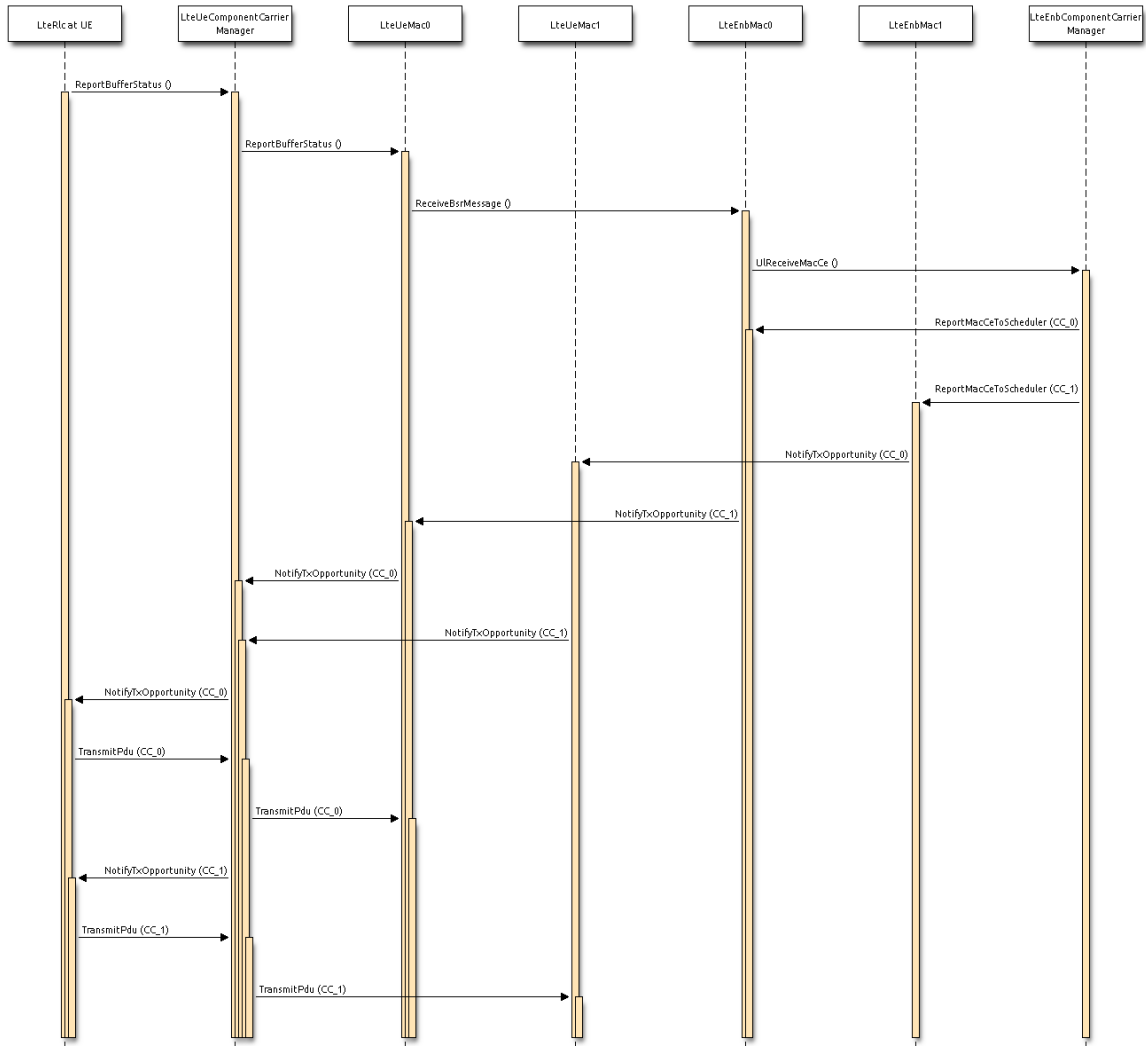

Fig. 68: Uplink buffer status reporting with CA

Each component carrier control SAP (both for PHY and MAC layer objects) is linked in a one-to-one fashion directly to the RRC instance. The Ue RRC instance is then connected to the `LteUeComponentCarrierManager` in the same way as in the eNB.

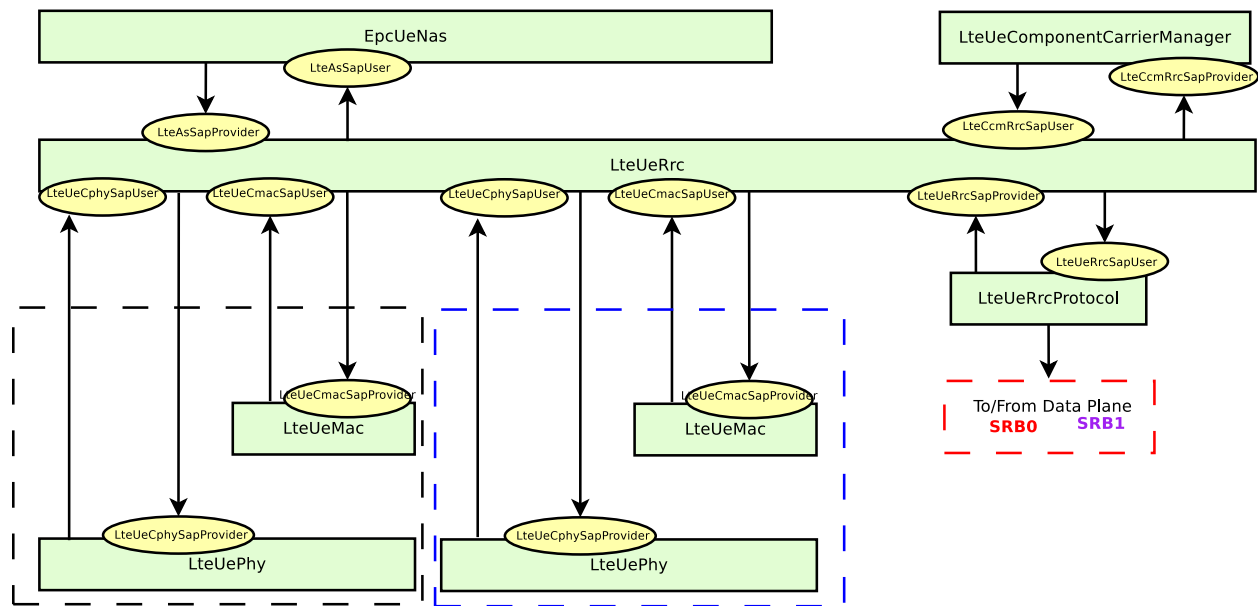

Fig. 69: UE Control Plane Architecture

`CCHelper` is the class that is implemented to help the configuration of the physical layer parameters, such as uplink and downlink, bandwidth and EARFCN of each carrier.

### CCM RRC MAC interfaces

The Component carrier manager (CCM) is also developed by using the SAP interface design. The following SAP interfaces are implemented for CCM and MAC:

- the `LteCcmMacSapUser` part is provided by MAC and is used by the CCM
- the `LteCcmMacSapProvider` part is provided by CCM and is used by the MAC layer

When the primary component carrier receives an uplink BSR it uses the `LteCcmMacSapUser` to forward it to the CCM, which should decide how to split the traffic corresponding to this BSR among carriers. Once this decision is made, the CCM uses the `LteCcmMacSapProvider` interface to send back an uplink BSR to some of the MAC instances. Additionally, the `LteCcmMacSapUser` can be used by the MAC to notify about the PRB occupancy in the downlink to the CCM. This information may be used by the CCM to decide how to split the traffic and whether to use the secondary carriers.

### CCM RRC SAP interfaces

The following SAP interfaces are implemented for CCM and RRC:

- the `LteCcmRrcSapProvider` is provided by the CCM and is used by the RRC layer
- the `LteCcmRrcSapUser` is provided by RRC and is used by the CCM

By using the `LteCcmRrcSapUser` the CCM may request a specific measurement reporting configuration to be fulfilled by the UEs attached to the eNB. When a UE measurement report is received, as a result of this configuration, the

eNB RRC entity shall forward this report to the CCM through the `LteCcmRrcSapProvider::ReportUeMeas` SAP function. Additionally, the `LteCcmRrcSapProvider` offers different functions to the RRC that can be used to add and remove of UEs, setup or release of radio bearer, configuration of the signalling bearer, etc.

## Component carrier managers

Currently, there are two component carrier manager implementations available. The first one is the `NoOpComponentCarrierManager`, which is the default CCM choice. When this CCM is used the carrier aggregation feature is disabled. This CCM forwards all traffic, the uplink and the downlink, over the primary carrier, and does not use secondary carriers. Another implementation is the `RrComponentCarrierManager`, which splits the traffic equally among carriers, by dividing the buffer status report among different carriers. SRB0 and SRB1 flows will be forwarded only over primary carrier.

### 19.1.18 Helpers

Two helper objects are used to setup simulations and configure the various components. These objects are:

- `LteHelper`, which takes care of the configuration of the LTE radio access network, as well as of coordinating the setup and release of EPS bearers. The `LteHelper` class provides both the API definition and its implementation.
- `EpcHelper`, which takes care of the configuration of the Evolved Packet Core. The `EpcHelper` class is an abstract base class, which only provides the API definition; the implementation is delegated to the child classes in order to allow for different EPC network models.

A third helper object is used to configure the *Carrier Aggregation* functionality:

- `CcHelper`, which takes care of the configuration of the `LteEnbComponentCarrierMap`, basically, it creates a user specified number of `LteEnbComponentCarrier`. `LteUeComponentCarrierMap` is currently created starting from the `LteEnbComponentCarrierMap`. `LteHelper::InstallSingleUeDevice`, in this implementation, is needed to invoke after the `LteHelper::InstallSingleEnbDevice` to ensure that the `LteEnbComponentCarrierMap` is properly initialized.

It is possible to create a simple LTE-only simulations by using the `LteHelper` alone, or to create complete LTE-EPC simulations by using both `LteHelper` and `EpcHelper`. When both helpers are used, they interact in a master-slave fashion, with the `LteHelper` being the Master that interacts directly with the user program, and the `EpcHelper` working “under the hood” to configure the EPC upon explicit methods called by the `LteHelper`. The exact interactions are displayed in the Figure *Sequence diagram of the interaction between LteHelper and EpcHelper*.

## 19.2 User Documentation

### 19.2.1 Background

We assume the reader is already familiar with how to use the ns-3 simulator to run generic simulation programs. If this is not the case, we strongly recommend the reader to consult [ns3tutorial].

### 19.2.2 Usage Overview

The ns-3 LTE model is a software library that allows the simulation of LTE networks, optionally including the Evolved Packet Core (EPC). The process of performing such simulations typically involves the following steps:

1. *Define the scenario* to be simulated



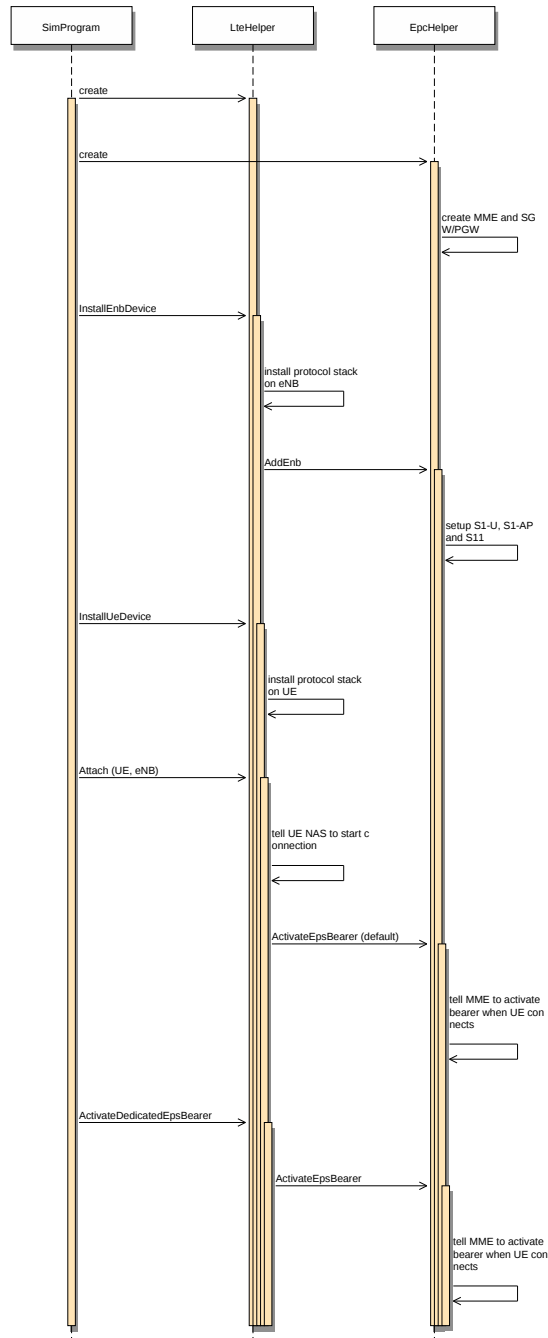

Fig. 70: Sequence diagram of the interaction between LteHelper and EpcHelper.

2. *Write a simulation program* that recreates the desired scenario topology/architecture. This is done accessing the ns-3 LTE model library using the `ns3::LteHelper` API defined in `src/lte/helper/lte-helper.h`.
3. *Specify configuration parameters* of the objects that are being used for the simulation. This can be done using input files (via the `ns3::ConfigStore`) or directly within the simulation program.
4. *Configure the desired output* to be produced by the simulator
5. *Run* the simulation.

All these aspects will be explained in the following sections by means of practical examples.

### 19.2.3 Basic simulation program

Here is the minimal simulation program that is needed to do an LTE-only simulation (without EPC).

1. Initial boilerplate:

```
#include <ns3/core-module.h>
#include <ns3/network-module.h>
#include <ns3/mobility-module.h>
#include <ns3/lte-module.h>

using namespace ns3;

int main (int argc, char *argv[])
{
    // the rest of the simulation program follows
```

2. Create an `LteHelper` object:

```
Ptr<LteHelper> lteHelper = CreateObject<LteHelper> ();
```

This will instantiate some common objects (e.g., the Channel object) and provide the methods to add eNBs and UEs and configure them.

3. Create `Node` objects for the eNB(s) and the UEs:

```
NodeContainer enbNodes;
enbNodes.Create (1);
NodeContainer ueNodes;
ueNodes.Create (2);
```

Note that the above `Node` instances at this point still don't have an LTE protocol stack installed; they're just empty nodes.

4. Configure the `Mobility` model for all the nodes:

```
MobilityHelper mobility;
mobility.SetMobilityModel ("ns3::ConstantPositionMobilityModel");
mobility.Install (enbNodes);
mobility.SetMobilityModel ("ns3::ConstantPositionMobilityModel");
mobility.Install (ueNodes);
```

The above will place all nodes at the coordinates (0,0,0). Please refer to the documentation of the ns-3 mobility model for how to set your own position or configure node movement.

5. Install an LTE protocol stack on the eNB(s):

```
NetDeviceContainer enbDevs;
enbDevs = lteHelper->InstallEnbDevice (enbNodes);
```

6. Install an LTE protocol stack on the UEs:

```
NetDeviceContainer ueDevs;
ueDevs = lteHelper->InstallUeDevice (ueNodes);
```

7. Attach the UEs to an eNB. This will configure each UE according to the eNB configuration, and create an RRC connection between them:

```
lteHelper->Attach (ueDevs, enbDevs.Get (0));
```

8. Activate a data radio bearer between each UE and the eNB it is attached to:

```
enum EpsBearer::Qci q = EpsBearer::GBR_CONV_VOICE;
EpsBearer bearer (q);
lteHelper->ActivateDataRadioBearer (ueDevs, bearer);
```

this method will also activate two saturation traffic generators for that bearer, one in uplink and one in downlink.

9. Set the stop time:

```
Simulator::Stop (Seconds (0.005));
```

This is needed otherwise the simulation will last forever, because (among others) the start-of-subframe event is scheduled repeatedly, and the ns-3 simulator scheduler will hence never run out of events.

10. Run the simulation:

```
Simulator::Run ();
```

11. Cleanup and exit:

```
Simulator::Destroy ();
return 0;
}
```

For how to compile and run simulation programs, please refer to [\[ns3tutorial\]](#).

## 19.2.4 Configuration of LTE model parameters

All the relevant LTE model parameters are managed through the ns-3 attribute system. Please refer to the [\[ns3tutorial\]](#) and [\[ns3manual\]](#) for detailed information on all the possible methods to do it (environmental variables, C++ API, GtkConfigStore...).

In the following, we just briefly summarize how to do it using input files together with the ns-3 ConfigStore. First of all, you need to put the following in your simulation program, right after `main ()` starts:

```
CommandLine cmd (__FILE__);
cmd.Parse (argc, argv);
ConfigStore inputConfig;
inputConfig.ConfigureDefaults ();
// parse again so you can override default values from the command line
cmd.Parse (argc, argv);
```

for the above to work, make sure you also `#include "ns3/config-store.h"`. Now create a text file named (for example) `input-defaults.txt` specifying the new default values that you want to use for some attributes:

```
default ns3::LteHelper::Scheduler "ns3::PffMacScheduler"
default ns3::LteHelper::PathlossModel "ns3::FriisSpectrumPropagationLossModel"
default ns3::LteEnbNetDevice::UlBandwidth "25"
default ns3::LteEnbNetDevice::DlBandwidth "25"
default ns3::LteEnbNetDevice::DlEarfcn "100"
default ns3::LteEnbNetDevice::UlEarfcn "18100"
default ns3::LteUePhy::TxPower "10"
default ns3::LteUePhy::NoiseFigure "9"
default ns3::LteEnbPhy::TxPower "30"
default ns3::LteEnbPhy::NoiseFigure "5"
```

Supposing your simulation program is called `src/lte/examples/lte-sim-with-input`, you can now pass these settings to the simulation program in the following way:

```
./waf --command-template="%s --ns3::ConfigStore::Filename=input-defaults.txt
--ns3::ConfigStore::Mode=Load --ns3::ConfigStore::FileFormat=RawText"
--run src/lte/examples/lte-sim-with-input
```

Furthermore, you can generate a template input file with the following command:

```
./waf --command-template="%s --ns3::ConfigStore::Filename=input-defaults.txt
--ns3::ConfigStore::Mode=Save --ns3::ConfigStore::FileFormat=RawText"
--run src/lte/examples/lte-sim-with-input
```

note that the above will put in the file `input-defaults.txt` *all* the default values that are registered in your particular build of the simulator, including lots of non-LTE attributes.

## 19.2.5 Configure LTE MAC Scheduler

There are several types of LTE MAC scheduler user can choose here. User can use following codes to define scheduler type:

```
Ptr<LteHelper> lteHelper = CreateObject<LteHelper> ();
lteHelper->SetSchedulerType ("ns3::FdMtFfMacScheduler"); // FD-MT scheduler
lteHelper->SetSchedulerType ("ns3::TdTfMacScheduler"); // TD-MT scheduler
lteHelper->SetSchedulerType ("ns3::TtaFfMacScheduler"); // TTA scheduler
lteHelper->SetSchedulerType ("ns3::FdBetFfMacScheduler"); // FD-BET scheduler
lteHelper->SetSchedulerType ("ns3::TdBetFfMacScheduler"); // TD-BET scheduler
lteHelper->SetSchedulerType ("ns3::FdTbfqFfMacScheduler"); // FD-TBFQ scheduler
lteHelper->SetSchedulerType ("ns3::TdTbfqFfMacScheduler"); // TD-TBFQ scheduler
lteHelper->SetSchedulerType ("ns3::PssFfMacScheduler"); //PSS scheduler
```

TBFQ and PSS have more parameters than other schedulers. Users can define those parameters in following way:

```
* TBFQ scheduler::

Ptr<LteHelper> lteHelper = CreateObject<LteHelper> ();
lteHelper->SetSchedulerAttribute("DebtLimit", IntegerValue(yourvalue)); // default_
↪value -625000 bytes (-5Mb)
lteHelper->SetSchedulerAttribute("CreditLimit", UIntegerValue(yourvalue)); //_
↪default value 625000 bytes (5Mb)
lteHelper->SetSchedulerAttribute("TokenPoolSize", UIntegerValue(yourvalue)); //_
↪default value 1 byte
```

(continues on next page)

(continued from previous page)

```

lteHelper->SetSchedulerAttribute("CreditableThreshold", UIntegerValue(yourvalue)); //
↪ default value 0

* PSS scheduler::

Ptr<LteHelper> lteHelper = CreateObject<LteHelper> ();
lteHelper->SetSchedulerAttribute("nMux", UIntegerValue(yourvalue)); // the maximum_
↪ number of UE selected by TD scheduler
lteHelper->SetSchedulerAttribute("PssFdSchedulerType", StringValue("CoItA")); // PF_
↪ scheduler type in PSS

```

In TBFQ, default values of debt limit and credit limit are set to -5Mb and 5Mb respectively based on paper [FABokhari2009]. Current implementation does not consider credit threshold ( $C = 0$ ). In PSS, if user does not define nMux, PSS will set this value to half of total UE. The default FD scheduler is PFsch.

In addition, token generation rate in TBFQ and target bit rate in PSS need to be configured by Guarantee Bit Rate (GBR) or Maximum Bit Rate (MBR) in epc bearer QoS parameters. Users can use following codes to define GBR and MBR in both downlink and uplink:

```

Ptr<LteHelper> lteHelper = CreateObject<LteHelper> ();
enum EpsBearer::Qci q = EpsBearer::yourvalue; // define Qci type
GbrQosInformation qos;
qos.gbrDl = yourvalue; // Downlink GBR
qos.gbrUl = yourvalue; // Uplink GBR
qos.mbrDl = yourvalue; // Downlink MBR
qos.mbrUl = yourvalue; // Uplink MBR
EpsBearer bearer (q, qos);
lteHelper->ActivateDedicatedEpsBearer (ueDevs, bearer, EpcTft::Default ());

```

In PSS, TBR is obtained from GBR in bearer level QoS parameters. In TBFQ, token generation rate is obtained from the MBR setting in bearer level QoS parameters, which therefore needs to be configured consistently. For constant bit rate (CBR) traffic, it is suggested to set MBR to GBR. For variance bit rate (VBR) traffic, it is suggested to set MBR k times larger than GBR in order to cover the peak traffic rate. In current implementation, k is set to three based on paper [FABokhari2009]. In addition, current version of TBFQ does not consider RLC header and PDCP header length in MBR and GBR. Another parameter in TBFQ is packet arrival rate. This parameter is calculated within scheduler and equals to the past average throughput which is used in PF scheduler.

Many useful attributes of the LTE-EPC model will be described in the following subsections. Still, there are many attributes which are not explicitly mentioned in the design or user documentation, but which are clearly documented using the ns-3 attribute system. You can easily print a list of the attributes of a given object together with their description and default value passing `--PrintAttributes=` to a simulation program, like this:

```
./waf --run lena-simple --command-template="%s --PrintAttributes=ns3::LteHelper"
```

You can try also with other LTE and EPC objects, like this:

```

./waf --run lena-simple --command-template="%s --PrintAttributes=ns3::LteEnbNetDevice"
./waf --run lena-simple --command-template="%s --PrintAttributes=ns3::LteEnbMac"
./waf --run lena-simple --command-template="%s --PrintAttributes=ns3::LteEnbPhy"
./waf --run lena-simple --command-template="%s --PrintAttributes=ns3::LteUePhy"
./waf --run lena-simple --command-template="%s --
↪PrintAttributes=ns3::PointToPointEpcHelper"

```

## 19.2.6 Simulation Output

The ns-3 LTE model currently supports the output to file of PHY, MAC, RLC and PDCP level Key Performance Indicators (KPIs). You can enable it in the following way:

```
Ptr<LteHelper> lteHelper = CreateObject<LteHelper> ();

// configure all the simulation scenario here...

lteHelper->EnablePhyTraces ();
lteHelper->EnableMacTraces ();
lteHelper->EnableRlcTraces ();
lteHelper->EnablePdcpcTraces ();

Simulator::Run ();
```

RLC and PDCP KPIs are calculated over a time interval and stored on ASCII files, two for RLC KPIs and two for PDCP KPIs, in each case one for uplink and one for downlink. The time interval duration can be controlled using the attribute `ns3::RadioBearerStatsCalculator::EpochDuration`.

The columns of the RLC KPI files is the following (the same for uplink and downlink):

1. start time of measurement interval in seconds since the start of simulation
2. end time of measurement interval in seconds since the start of simulation
3. Cell ID
4. unique UE ID (IMSI)
5. cell-specific UE ID (RNTI)
6. Logical Channel ID
7. Number of transmitted RLC PDUs
8. Total bytes transmitted.
9. Number of received RLC PDUs
10. Total bytes received
11. Average RLC PDU delay in seconds
12. Standard deviation of the RLC PDU delay
13. Minimum value of the RLC PDU delay
14. Maximum value of the RLC PDU delay
15. Average RLC PDU size, in bytes
16. Standard deviation of the RLC PDU size
17. Minimum RLC PDU size
18. Maximum RLC PDU size

Similarly, the columns of the PDCP KPI files is the following (again, the same for uplink and downlink):

1. start time of measurement interval in seconds since the start of simulation
2. end time of measurement interval in seconds since the start of simulation
3. Cell ID
4. unique UE ID (IMSI)

5. cell-specific UE ID (RNTI)
6. Logical Channel ID
7. Number of transmitted PDCP PDUs
8. Total bytes transmitted.
9. Number of received PDCP PDUs
10. Total bytes received
11. Average PDCP PDU delay in seconds
12. Standard deviation of the PDCP PDU delay
13. Minimum value of the PDCP PDU delay
14. Maximum value of the PDCP PDU delay
15. Average PDCP PDU size, in bytes
16. Standard deviation of the PDCP PDU size
17. Minimum PDCP PDU size
18. Maximum PDCP PDU size

**Note:** The PDCP traces for data radio bearers are not generated when *SM RLC* is used.

MAC KPIs are basically a trace of the resource allocation reported by the scheduler upon the start of every subframe. They are stored in ASCII files. For downlink MAC KPIs the format is the following:

1. Simulation time in seconds at which the allocation is indicated by the scheduler
2. Cell ID
3. unique UE ID (IMSI)
4. Frame number
5. Subframe number
6. cell-specific UE ID (RNTI)
7. MCS of TB 1
8. size of TB 1
9. MCS of TB 2 (0 if not present)
10. size of TB 2 (0 if not present)

while for uplink MAC KPIs the format is:

1. Simulation time in seconds at which the allocation is indicated by the scheduler
2. Cell ID
3. unique UE ID (IMSI)
4. Frame number
5. Subframe number
6. cell-specific UE ID (RNTI)
7. MCS of TB
8. size of TB

The names of the files used for MAC KPI output can be customized via the ns-3 attributes `ns3::MacStatsCalculator::DlOutputFilename` and `ns3::MacStatsCalculator::UlOutputFilename`.

PHY KPIs are distributed in seven different files, configurable through the attributes

1. `ns3::PhyStatsCalculator::DlRsrpSinrFilename`
2. `ns3::PhyStatsCalculator::UeSinrFilename`
3. `ns3::PhyStatsCalculator::InterferenceFilename`
4. `ns3::PhyStatsCalculator::DlTxOutputFilename`
5. `ns3::PhyStatsCalculator::UlTxOutputFilename`
6. `ns3::PhyStatsCalculator::DlRxOutputFilename`
7. `ns3::PhyStatsCalculator::UlRxOutputFilename`

In the RSRP/SINR file, the following content is available:

1. Simulation time in seconds at which the allocation is indicated by the scheduler
2. Cell ID
3. unique UE ID (IMSI)
4. RSRP
5. Linear average over all RBs of the downlink SINR in linear units

The contents in the UE SINR file are:

1. Simulation time in seconds at which the allocation is indicated by the scheduler
2. Cell ID
3. unique UE ID (IMSI)
4. uplink SINR in linear units for the UE

In the interference filename the content is:

1. Simulation time in seconds at which the allocation is indicated by the scheduler
2. Cell ID
3. List of interference values per RB

In UL and DL transmission files the parameters included are:

1. Simulation time in milliseconds
2. Cell ID
3. unique UE ID (IMSI)
4. RNTI
5. Layer of transmission
6. MCS
7. size of the TB
8. Redundancy version
9. New Data Indicator flag

And finally, in UL and DL reception files the parameters included are:



1. Simulation time in milliseconds
2. Cell ID
3. unique UE ID (IMSI)
4. RNTI
5. Transmission Mode
6. Layer of transmission
7. MCS
8. size of the TB
9. Redundancy version
10. New Data Indicator flag
11. Correctness in the reception of the TB

**Note:** The traces generated by simulating the scenarios involving the RLF will have a discontinuity in time from the moment of the RLF event until the UE connects again to an eNB.

## 19.2.7 Fading Trace Usage

In this section we will describe how to use fading traces within LTE simulations.

### Fading Traces Generation

It is possible to generate fading traces by using a dedicated matlab script provided with the code (`/lte/model/fading-traces/fading-trace-generator.m`). This script already includes the typical taps configurations for three 3GPP scenarios (i.e., pedestrian, vehicular and urban as defined in Annex B.2 of [TS36104]); however users can also introduce their specific configurations. The list of the configurable parameters is provided in the following:

- `fc` : the frequency in use (it affects the computation of the doppler speed).
- `v_km_h` : the speed of the users
- `traceDuration` : the duration in seconds of the total length of the trace.
- `numRBs` : the number of the resource block to be evaluated.
- `tag` : the tag to be applied to the file generated.

The file generated contains ASCII-formatted real values organized in a matrix fashion: every row corresponds to a different RB, and every column correspond to a different temporal fading trace sample.

It has to be noted that the ns-3 LTE module is able to work with any fading trace file that complies with the above described ASCII format. Hence, other external tools can be used to generate custom fading traces, such as for example other simulators or experimental devices.

### Fading Traces Usage

When using a fading trace, it is of paramount importance to specify correctly the trace parameters in the simulation, so that the fading model can load and use it correctly. The parameters to be configured are:

- `TraceFilename` : the name of the trace to be loaded (absolute path, or relative path w.r.t. the path from where the simulation program is executed);
- `TraceLength` : the trace duration in seconds;

- `SamplesNum` : the number of samples;
- `WindowSize` : the size of the fading sampling window in seconds;

It is important to highlight that the sampling interval of the fading trace has to be 1 ms or greater, and in the latter case it has to be an integer multiple of 1 ms in order to be correctly processed by the fading module.

The default configuration of the matlab script provides a trace 10 seconds long, made of 10,000 samples (i.e., 1 sample per TTI=1ms) and used with a windows size of 0.5 seconds amplitude. These are also the default values of the parameters above used in the simulator; therefore their settagge can be avoided in case the fading trace respects them.

In order to activate the fading module (which is not active by default) the following code should be included in the simulation program:

```
Ptr<LteHelper> lteHelper = CreateObject<LteHelper> ();
lteHelper->SetFadingModel ("ns3::TraceFadingLossModel");
```

And for setting the parameters:

```
lteHelper->SetFadingModelAttribute ("TraceFilename", StringValue ("src/lte/model/
↪fading-traces/fading_trace_EPA_3kmph.fad"));
lteHelper->SetFadingModelAttribute ("TraceLength", TimeValue (Seconds (10.0)));
lteHelper->SetFadingModelAttribute ("SamplesNum", UIntegerValue (10000));
lteHelper->SetFadingModelAttribute ("WindowSize", TimeValue (Seconds (0.5)));
lteHelper->SetFadingModelAttribute ("RbNum", UIntegerValue (100));
```

It has to be noted that, `TraceFilename` does not have a default value, therefore is has to be always set explicitly.

The simulator provide natively three fading traces generated according to the configurations defined in in Annex B.2 of [TS36104]. These traces are available in the folder `src/lte/model/fading-traces/`). An excerpt from these traces is represented in the following figures.

## 19.2.8 Mobility Model with Buildings

We now explain by examples how to use the buildings model (in particular, the `MobilityBuildingInfo` and the `BuildingPropagationModel` classes) in an ns-3 simulation program to setup an LTE simulation scenario that includes buildings and indoor nodes.

1. Header files to be included:

```
#include <ns3/mobility-building-info.h>
#include <ns3/buildings-propagation-loss-model.h>
#include <ns3/building.h>
```

2. Pathloss model selection:

```
Ptr<LteHelper> lteHelper = CreateObject<LteHelper> ();

lteHelper->SetAttribute ("PathlossModel", StringValue (
↪"ns3::BuildingsPropagationLossModel"));
```

3. EUTRA Band Selection

The selection of the working frequency of the propagation model has to be done with the standard ns-3 attribute system as described in the correspond section (“Configuration of LTE model parameters”) by means of the `DlEarfcn` and `UlEarfcn` parameters, for instance:

```
lteHelper->SetEnbDeviceAttribute ("DlEarfcn", UIntegerValue (100));
lteHelper->SetEnbDeviceAttribute ("UlEarfcn", UIntegerValue (18100));
```

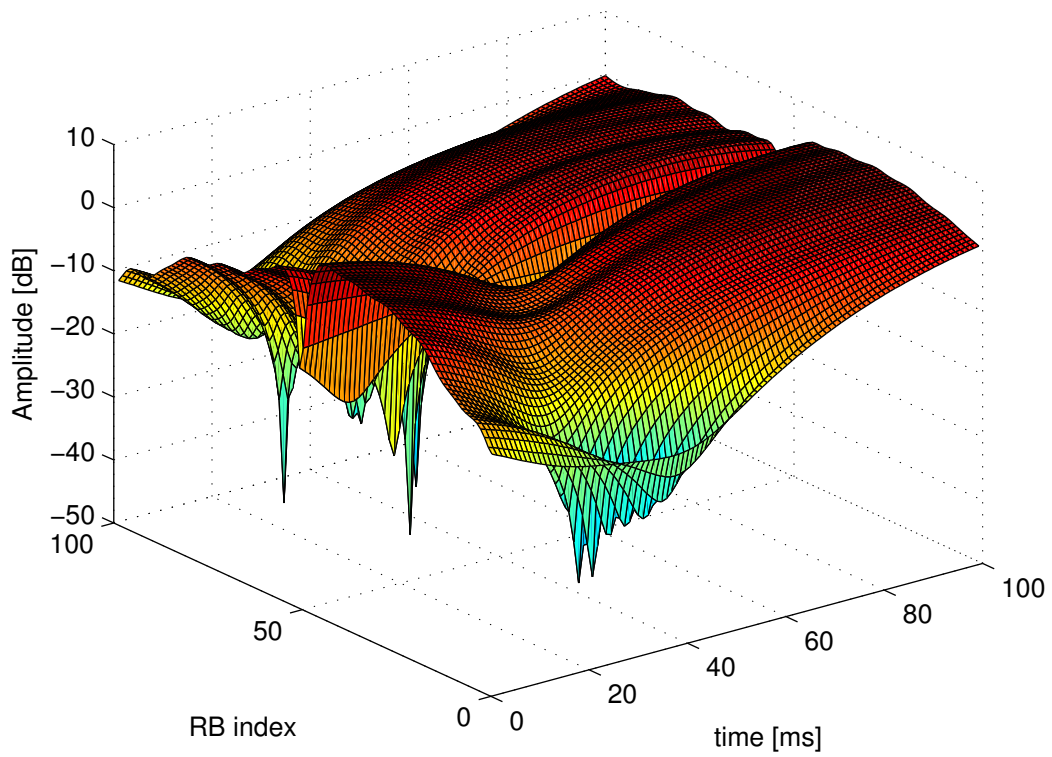

Fig. 71: Excerpt of the fading trace included in the simulator for a pedestrian scenario (speed of 3 kmph).

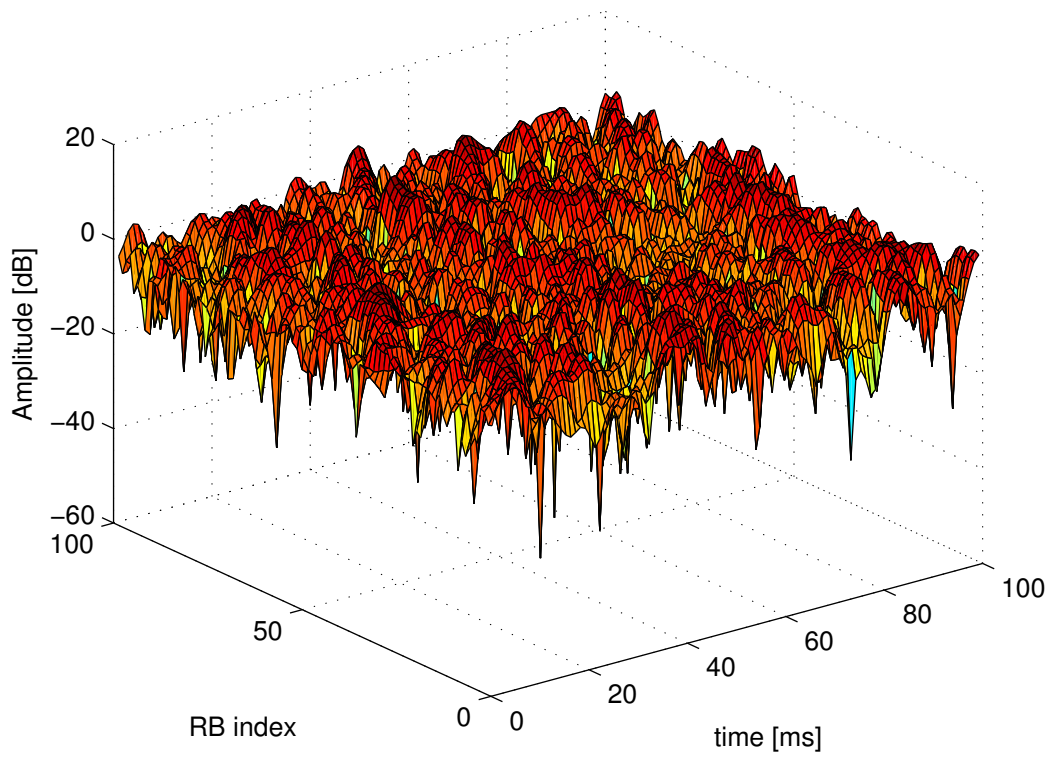

Fig. 72: Excerpt of the fading trace included in the simulator for a vehicular scenario (speed of 60 kmph).

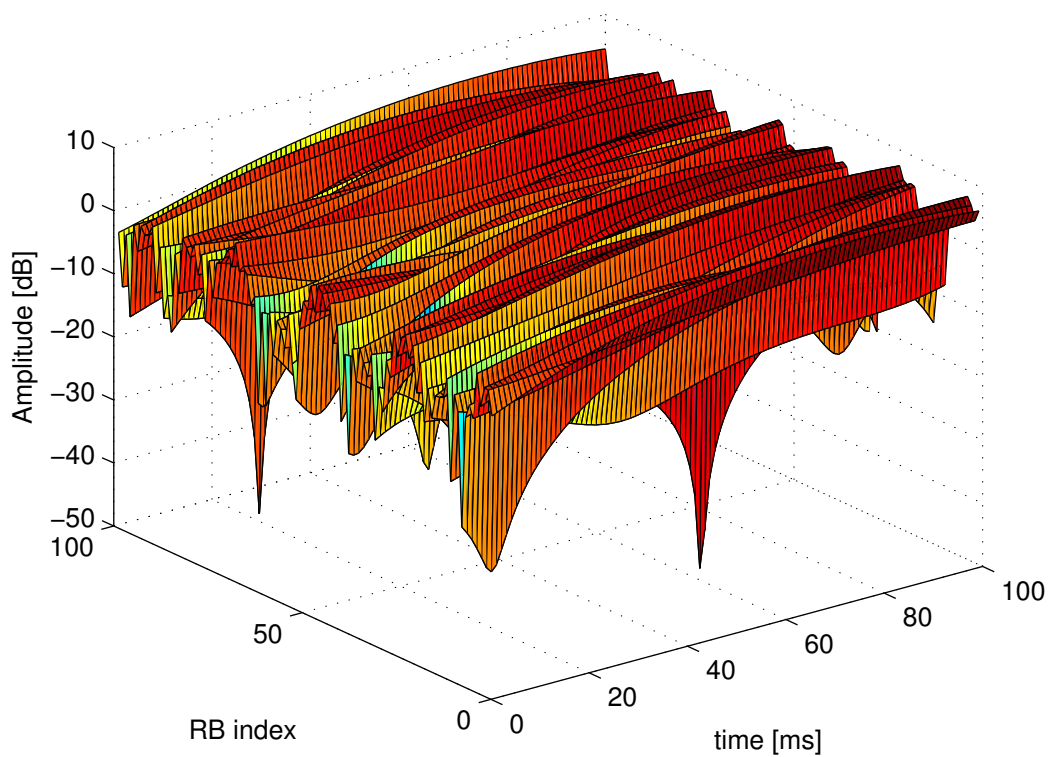

Fig. 73: Excerpt of the fading trace included in the simulator for an urban scenario (speed of 3 kmph).

It is to be noted that using other means to configure the frequency used by the propagation model (i.e., configuring the corresponding `BuildingsPropagationLossModel` attributes directly) might generate conflicts in the frequencies definition in the modules during the simulation, and is therefore not advised.

1. Mobility model selection:

```
MobilityHelper mobility;  
mobility.SetMobilityModel ("ns3::ConstantPositionMobilityModel");
```

It is to be noted that any mobility model can be used.

2. Building creation:

```
double x_min = 0.0;  
double x_max = 10.0;  
double y_min = 0.0;  
double y_max = 20.0;  
double z_min = 0.0;  
double z_max = 10.0;  
Ptr<Building> b = CreateObject <Building> ();  
b->SetBoundaries (Box (x_min, x_max, y_min, y_max, z_min, z_max));  
b->SetBuildingType (Building::Residential);  
b->SetExtWallsType (Building::ConcreteWithWindows);  
b->SetNFloors (3);  
b->SetNRoomsX (3);  
b->SetNRoomsY (2);
```

This will instantiate a residential building with base of 10 x 20 meters and height of 10 meters whose external walls are of concrete with windows; the building has three floors and has an internal 3 x 2 grid of rooms of equal size.

3. Node creation and positioning:

```
ueNodes.Create (2);  
mobility.Install (ueNodes);  
BuildingsHelper::Install (ueNodes);  
NetDeviceContainer ueDevs;  
ueDevs = lteHelper->InstallUeDevice (ueNodes);  
Ptr<ConstantPositionMobilityModel> mm0 = enbNodes.Get (0)->GetObject  
↪<ConstantPositionMobilityModel> ();  
Ptr<ConstantPositionMobilityModel> mm1 = enbNodes.Get (1)->GetObject  
↪<ConstantPositionMobilityModel> ();  
mm0->SetPosition (Vector (5.0, 5.0, 1.5));  
mm1->SetPosition (Vector (30.0, 40.0, 1.5));
```

4. Finalize the building and mobility model configuration:

```
BuildingsHelper::MakeMobilityModelConsistent ();
```

See the documentation of the *buildings* module for more detailed information.

## 19.2.9 PHY Error Model

The Physical error model consists of the data error model and the downlink control error model, both of them active by default. It is possible to deactivate them with the ns3 attribute system, in detail:

```

Config::SetDefault ("ns3::LteSpectrumPhy::CtrlErrorModelEnabled", BooleanValue_
↳(false));
Config::SetDefault ("ns3::LteSpectrumPhy::DataErrorModelEnabled", BooleanValue_
↳(false));

```

## 19.2.10 MIMO Model

In this subsection we illustrate how to configure the MIMO parameters. LTE defines 7 types of transmission modes:

- Transmission Mode 1: SISO.
- Transmission Mode 2: MIMO Tx Diversity.
- Transmission Mode 3: MIMO Spatial Multiplexity Open Loop.
- Transmission Mode 4: MIMO Spatial Multiplexity Closed Loop.
- Transmission Mode 5: MIMO Multi-User.
- Transmission Mode 6: Closer loop single layer precoding.
- Transmission Mode 7: Single antenna port 5.

According to model implemented, the simulator includes the first three transmission modes types. The default one is the Transmission Mode 1 (SISO). In order to change the default Transmission Mode to be used, the attribute `DefaultTransmissionMode` of the `LteEnbRrc` can be used, as shown in the following:

```

Config::SetDefault ("ns3::LteEnbRrc::DefaultTransmissionMode", UIntegerValue (0)); //
↳SISO
Config::SetDefault ("ns3::LteEnbRrc::DefaultTransmissionMode", UIntegerValue (1)); //
↳MIMO Tx diversity (1 layer)
Config::SetDefault ("ns3::LteEnbRrc::DefaultTransmissionMode", UIntegerValue (2)); //
↳MIMO Spatial Multiplexity (2 layers)

```

For changing the transmission mode of a certain user during the simulation a specific interface has been implemented in both standard schedulers:

```
void TransmissionModeConfigurationUpdate (uint16_t rnti, uint8_t txMode);
```

This method can be used both for developing transmission mode decision engine (i.e., for optimizing the transmission mode according to channel condition and/or user's requirements) and for manual switching from simulation script. In the latter case, the switching can be done as shown in the following:

```

Ptr<LteEnbNetDevice> lteEnbDev = enbDevs.Get (0)->GetObject<LteEnbNetDevice> ();
PointerValue ptrval;
enbNetDev->GetAttribute ("FfMacScheduler", ptrval);
Ptr<RrFfMacScheduler> rrsched = ptrval.Get<RrFfMacScheduler> ();
Simulator::Schedule (Seconds (0.2), &
↳RrFfMacScheduler::TransmissionModeConfigurationUpdate, rrsched, rnti, 1);

```

Finally, the model implemented can be reconfigured according to different MIMO models by updating the gain values (the only constraints is that the gain has to be constant during simulation run-time and common for the layers). The gain of each Transmission Mode can be changed according to the standard ns3 attribute system, where the attributes are: `TxMode1Gain`, `TxMode2Gain`, `TxMode3Gain`, `TxMode4Gain`, `TxMode5Gain`, `TxMode6Gain` and `TxMode7Gain`. By default only `TxMode1Gain`, `TxMode2Gain` and `TxMode3Gain` have a meaningful value, that are the ones derived by `_[CatreuxMIMO]` (i.e., respectively 0.0, 4.2 and -2.8 dB).

### 19.2.11 Use of AntennaModel

We now show how associate a particular `AntennaModel` with an eNB device in order to model a sector of a macro eNB. For this purpose, it is convenient to use the `CosineAntennaModel` provided by the ns-3 antenna module. The configuration of the eNB is to be done via the `LteHelper` instance right before the creation of the `EnbNetDevice`, as shown in the following:

```
lteHelper->SetEnbAntennaModelType ("ns3::CosineAntennaModel");
lteHelper->SetEnbAntennaModelAttribute ("Orientation", DoubleValue (0));
lteHelper->SetEnbAntennaModelAttribute ("Beamwidth", DoubleValue (60));
lteHelper->SetEnbAntennaModelAttribute ("MaxGain", DoubleValue (0.0));
```

the above code will generate an antenna model with a 60 degrees beamwidth pointing along the X axis. The orientation is measured in degrees from the X axis, e.g., an orientation of 90 would point along the Y axis, and an orientation of -90 would point in the negative direction along the Y axis. The beamwidth is the -3 dB beamwidth, e.g, for a 60 degree beamwidth the antenna gain at an angle of  $\pm 30$  degrees from the direction of orientation is -3 dB.

To create a multi-sector site, you need to create different ns-3 nodes placed at the same position, and to configure separate `EnbNetDevice` with different antenna orientations to be installed on each node.

### 19.2.12 Radio Environment Maps

By using the class `RadioEnvironmentMapHelper` it is possible to output to a file a Radio Environment Map (REM), i.e., a uniform 2D grid of values that represent the Signal-to-noise ratio in the downlink with respect to the eNB that has the strongest signal at each point. It is possible to specify if REM should be generated for data or control channel. Also user can set the `RbId`, for which REM will be generated. Default `RbId` is -1, what means that REM will generated with averaged Signal-to-noise ratio from all RBs.

To do this, you just need to add the following code to your simulation program towards the end, right before the call to `Simulator::Run ()`:

```
Ptr<RadioEnvironmentMapHelper> remHelper = CreateObject<RadioEnvironmentMapHelper> ();
remHelper->SetAttribute ("ChannelPath", StringValue ("/ChannelList/0"));
remHelper->SetAttribute ("OutputFile", StringValue ("rem.out"));
remHelper->SetAttribute ("XMin", DoubleValue (-400.0));
remHelper->SetAttribute ("XMax", DoubleValue (400.0));
remHelper->SetAttribute ("XRes", UIntegerValue (100));
remHelper->SetAttribute ("YMin", DoubleValue (-300.0));
remHelper->SetAttribute ("YMax", DoubleValue (300.0));
remHelper->SetAttribute ("YRes", UIntegerValue (75));
remHelper->SetAttribute ("Z", DoubleValue (0.0));
remHelper->SetAttribute ("UseDataChannel", BooleanValue (true));
remHelper->SetAttribute ("RbId", IntegerValue (10));
remHelper->Install ();
```

By configuring the attributes of the `RadioEnvironmentMapHelper` object as shown above, you can tune the parameters of the REM to be generated. Note that each `RadioEnvironmentMapHelper` instance can generate only one REM; if you want to generate more REMs, you need to create one separate instance for each REM.

Note that the REM generation is very demanding, in particular:

- the run-time memory consumption is approximately 5KB per pixel. For example, a REM with a resolution of 500x500 would need about 1.25 GB of memory, and a resolution of 1000x1000 would need needs about 5 GB (too much for a regular PC at the time of this writing). To overcome this issue, the REM is generated at successive steps, with each step evaluating at most a number of pixels determined by the value of the attribute `RadioEnvironmentMapHelper::MaxPointsPerIteration`.



- if you generate a REM at the beginning of a simulation, it will slow down the execution of the rest of the simulation. If you want to generate a REM for a program and also use the same program to get simulation result, it is recommended to add a command-line switch that allows to either generate the REM or run the complete simulation. For this purpose, note that there is an attribute `RadioEnvironmentMapHelper::StopWhenDone` (default: true) that will force the simulation to stop right after the REM has been generated.

The REM is stored in an ASCII file in the following format:

- column 1 is the x coordinate
- column 2 is the y coordinate
- column 3 is the z coordinate
- column 4 is the SINR in linear units

A minimal gnuplot script that allows you to plot the REM is given below:

```
set view map;
set xlabel "X"
set ylabel "Y"
set cblabel "SINR (dB)"
unset key
plot "rem.out" using ($1):($2):(10*log10($4)) with image
```

As an example, here is the REM that can be obtained with the example program `lena-dual-stripe`, which shows a three-sector LTE macrocell in a co-channel deployment with some residential femtocells randomly deployed in two blocks of apartments.

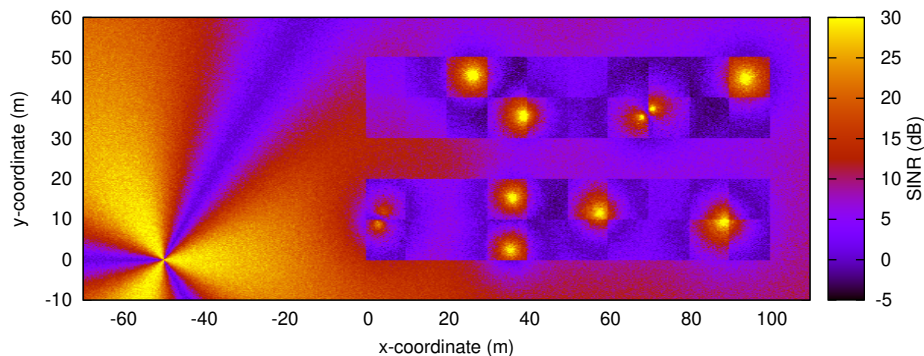

Fig. 74: REM obtained from the lena-dual-stripe example

Note that the `lena-dual-stripe` example program also generate gnuplot-compatible output files containing information about the positions of the UE and eNB nodes as well as of the buildings, respectively in the files `ues.txt`, `enbs.txt` and `buildings.txt`. These can be easily included when using gnuplot. For example, assuming that your gnuplot script (e.g., the minimal gnuplot script described above) is saved in a file named `my_plot_script`, running the following command would plot the location of UEs, eNBs and buildings on top of the REM:

```
gnuplot -p enbs.txt ues.txt buildings.txt my_plot_script
```

### 19.2.13 AMC Model and CQI Calculation

The simulator provides two possible schemes for what concerns the selection of the MCSs and correspondingly the generation of the CQIs. The first one is based on the GSoC module [Piro2011] and works per RB basis. This model can be activated with the ns3 attribute system, as presented in the following:

```
Config::SetDefault ("ns3::LteAmc::AmcModel", EnumValue (LteAmc::PiroEW2010));
```

While, the solution based on the physical error model can be controlled with:

```
Config::SetDefault ("ns3::LteAmc::AmcModel", EnumValue (LteAmc::MiErrorModel));
```

Finally, the required efficiency of the PiroEW2010 AMC module can be tuned thanks to the `Ber` attribute (), for instance:

```
Config::SetDefault ("ns3::LteAmc::Ber", DoubleValue (0.00005));
```

### 19.2.14 Evolved Packet Core (EPC)

We now explain how to write a simulation program that allows to simulate the EPC in addition to the LTE radio access network. The use of EPC allows to use IPv4 and IPv6 networking with LTE devices. In other words, you will be able to use the regular ns-3 applications and sockets over IPv4 and IPv6 over LTE, and also to connect an LTE network to any other IPv4 and IPv6 network you might have in your simulation.

First of all, in addition to `LteHelper` that we already introduced in *Basic simulation program*, you need to use an additional `EpcHelper` class, which will take care of creating the EPC entities and network topology. Note that you can't use `EpcHelper` directly, as it is an abstract base class; instead, you need to use one of its child classes, which provide different EPC topology implementations. In this example we will consider `PointToPointEpcHelper`, which implements an EPC based on point-to-point links. To use it, you need first to insert this code in your simulation program:

```
Ptr<LteHelper> lteHelper = CreateObject<LteHelper> ();  
Ptr<PointToPointEpcHelper> epcHelper = CreateObject<PointToPointEpcHelper> ();
```

Then, you need to tell the LTE helper that the EPC will be used:

```
lteHelper->SetEpcHelper (epcHelper);
```

the above step is necessary so that the LTE helper will trigger the appropriate EPC configuration in correspondence with some important configuration, such as when a new eNB or UE is added to the simulation, or an EPS bearer is created. The EPC helper will automatically take care of the necessary setup, such as S1 link creation and S1 bearer setup. All this will be done without the intervention of the user.

Calling `lteHelper->SetEpcHelper (epcHelper)` enables the use of EPC, and has the side effect that any new `LteEnbRrc` that is created will have the `EpsBearerToRlcMapping` attribute set to `RLC_UM_ALWAYS` instead of `RLC_SM_ALWAYS` if the latter was the default; otherwise, the attribute won't be changed (e.g., if you changed the default to `RLC_AM_ALWAYS`, it won't be touched).

It is to be noted that the `EpcHelper` will also automatically create the PGW node and configure it so that it can properly handle traffic from/to the LTE radio access network. Still, you need to add some explicit code to connect the PGW to other IPv4/IPv6 networks (e.g., the internet, another EPC). Here is a very simple example about how to connect a single remote host (IPv4 type) to the PGW via a point-to-point link:

```

Ptr<Node> pgw = epcHelper->GetPgwNode ();

// Create a single RemoteHost
NodeContainer remoteHostContainer;
remoteHostContainer.Create (1);
Ptr<Node> remoteHost = remoteHostContainer.Get (0);
InternetStackHelper internet;
internet.Install (remoteHostContainer);

// Create the internet
PointToPointHelper p2ph;
p2ph.SetDeviceAttribute ("DataRate", DataRateValue (DataRate ("100Gb/s")));
p2ph.SetDeviceAttribute ("Mtu", UintegerValue (1500));
p2ph.SetChannelAttribute ("Delay", TimeValue (Seconds (0.010)));
NetDeviceContainer internetDevices = p2ph.Install (pgw, remoteHost);
Ipv4AddressHelper ipv4h;
ipv4h.SetBase ("1.0.0.0", "255.0.0.0");
Ipv4InterfaceContainer internetIpIfaces = ipv4h.Assign (internetDevices);
// interface 0 is localhost, 1 is the p2p device
Ipv4Address remoteHostAddr = internetIpIfaces.GetAddress (1);

Ipv4StaticRoutingHelper ipv4RoutingHelper;
Ptr<Ipv4StaticRouting> remoteHostStaticRouting;
remoteHostStaticRouting = ipv4RoutingHelper.GetStaticRouting (remoteHost->GetObject
↳<Ipv4> ());
remoteHostStaticRouting->AddNetworkRouteTo (epcHelper->GetEpcIpv4NetworkAddress (),
                                             Ipv4Mask ("255.255.0.0"), 1);

```

Now, you should go on and create LTE eNBs and UEs as explained in the previous sections. You can of course configure other LTE aspects such as pathloss and fading models. Right after you created the UEs, you should also configure them for IP networking. This is done as follows. We assume you have a container for UE and eNodeB nodes like this:

```

NodeContainer ueNodes;
NodeContainer enbNodes;

```

to configure an LTE-only simulation, you would then normally do something like this:

```

NetDeviceContainer ueLteDevs = lteHelper->InstallUeDevice (ueNodes);
lteHelper->Attach (ueLteDevs, enbLteDevs.Get (0));

```

in order to configure the UEs for IP networking, you just need to additionally do like this:

```

// we install the IP stack on the UEs
InternetStackHelper internet;
internet.Install (ueNodes);

// assign IP address to UEs
for (uint32_t u = 0; u < ueNodes.GetN (); ++u)
{
    Ptr<Node> ue = ueNodes.Get (u);
    Ptr<NetDevice> ueLteDevice = ueLteDevs.Get (u);
    Ipv4InterfaceContainer ueIpIface;
    ueIpIface = epcHelper->AssignUeIpv4Address (NetDeviceContainer (ueLteDevice));
    // set the default gateway for the UE
    Ptr<Ipv4StaticRouting> ueStaticRouting;

```

(continues on next page)

(continued from previous page)

```

ueStaticRouting = ipv4RoutingHelper.GetStaticRouting (ue->GetObject<Ipv4> ());
ueStaticRouting->SetDefaultRoute (epcHelper->GetUeDefaultGatewayAddress (), 1);
}

```

The activation of bearers is done in a slightly different way with respect to what done for an LTE-only simulation. First, the method `ActivateDataRadioBearer` is not to be used when the EPC is used. Second, when EPC is used, the default EPS bearer will be activated automatically when you call `LteHelper::Attach ()`. Third, if you want to setup dedicated EPS bearer, you can do so using the method `LteHelper::ActivateDedicatedEpsBearer ()`. This method takes as a parameter the Traffic Flow Template (TFT), which is a struct that identifies the type of traffic that will be mapped to the dedicated EPS bearer. Here is an example for how to setup a dedicated bearer for an application at the UE communicating on port 1234:

```

Ptr<EpcTft> tft = Create<EpcTft> ();
EpcTft::PacketFilter pf;
pf.localPortStart = 1234;
pf.localPortEnd = 1234;
tft->Add (pf);
lteHelper->ActivateDedicatedEpsBearer (ueLteDevs,
                                     EpsBearer (EpsBearer::NGBR_VIDEO_TCP_DEFAULT),
                                     tft);

```

you can of course use custom `EpsBearer` and `EpcTft` configurations, please refer to the doxygen documentation for how to do it.

Finally, you can install applications on the LTE UE nodes that communicate with remote applications over the internet. This is done following the usual ns-3 procedures. Following our simple example with a single `remoteHost`, here is how to setup downlink communication, with an `UdpClient` application on the remote host, and a `PacketSink` on the LTE UE (using the same variable names of the previous code snippets)

```

uint16_t dlPort = 1234;
PacketSinkHelper packetSinkHelper ("ns3::UdpSocketFactory",
                                   InetSocketAddress (Ipv4Address::GetAny (), dlPort));
ApplicationContainer serverApps = packetSinkHelper.Install (ue);
serverApps.Start (Seconds (0.01));
UdpClientHelper client (ueIpIface.GetAddress (0), dlPort);
ApplicationContainer clientApps = client.Install (remoteHost);
clientApps.Start (Seconds (0.01));

```

That's all! You can now start your simulation as usual:

```

Simulator::Stop (Seconds (10.0));
Simulator::Run ();

```

### 19.2.15 Using the EPC with emulation mode

In the previous section we used `PointToPoint` links for the connection between the eNBs and the SGW (S1-U interface) and among eNBs (X2-U and X2-C interfaces). The LTE module supports using emulated links instead of `PointToPoint` links. This is achieved by just replacing the creation of `LteHelper` and `EpcHelper` with the following code:

```

Ptr<LteHelper> lteHelper = CreateObject<LteHelper> ();
Ptr<EmuEpcHelper> epcHelper = CreateObject<EmuEpcHelper> ();
lteHelper->SetEpcHelper (epcHelper);
epcHelper->Initialize ();

```

The attributes `ns3::EmuEpcHelper::sgwDeviceName` and `ns3::EmuEpcHelper::enbDeviceName` are used to set the name of the devices used for transporting the S1-U, X2-U and X2-C interfaces at the SGW and eNB, respectively. We will now show how this is done in an example where we execute the example program `lena-simple-epc-emu` using two virtual ethernet interfaces.

First of all we build ns-3 appropriately:

```
# configure
./waf configure --enable-sudo --enable-modules=lte,fd-net-device --enable-examples

# build
./waf
```

Then we setup two virtual ethernet interfaces, and start wireshark to look at the traffic going through:

```
# note: you need to be root

# create two paired veth devices
ip link add name veth0 type veth peer name veth1
ip link show

# enable promiscuous mode
ip link set veth0 promisc on
ip link set veth1 promisc on

# bring interfaces up
ip link set veth0 up
ip link set veth1 up

# start wireshark and capture on veth0
wireshark &
```

We can now run the example program with the simulated clock:

```
./waf --run lena-simple-epc-emu --command="%s" --ns3::EmuEpcHelper::sgwDeviceName=veth0
--ns3::EmuEpcHelper::enbDeviceName=veth1"
```

Using wireshark, you should see ARP resolution first, then some GTP packets exchanged both in uplink and downlink.

The default setting of the example program is 1 eNB and 1 UE. You can change this via command line parameters, e.g.:

```
./waf --run lena-simple-epc-emu --command="%s" --ns3::EmuEpcHelper::sgwDeviceName=veth0
--ns3::EmuEpcHelper::enbDeviceName=veth1 --nEnbs=2 --nUesPerEnb=2"
```

To get a list of the available parameters:

```
./waf --run lena-simple-epc-emu --command="%s" --PrintHelp"
```

To run with the realtime clock: it turns out that the default debug build is too slow for realtime. Softening the real time constraints with the `BestEffort` mode is not a good idea: something can go wrong (e.g., ARP can fail) and, if so, you won't get any data packets out. So you need a decent hardware and the optimized build with statically linked modules:

```
./waf configure -d optimized --enable-static --enable-modules=lte --enable-examples
--enable-sudo
```

Then run the example program like this:

```
./waf --run lena-simple-epc-emu --command="%s --ns3::EmuEpcHelper::sgwDeviceName=veth0
--ns3::EmuEpcHelper::enbDeviceName=veth1
--SimulatorImplementationType=ns3::RealtimeSimulatorImpl
--ns3::RealtimeSimulatorImpl::SynchronizationMode=HardLimit"
```

note the `HardLimit` setting, which will cause the program to terminate if it cannot keep up with real time.

The approach described in this section can be used with any type of net device. For instance, [Baldo2014] describes how it was used to run an emulated LTE-EPC network over a real multi-layer packet-optical transport network.

### 19.2.16 Custom Backhaul

In the previous sections, *Evolved Packet Core (EPC)*, we explained how to write a simulation program using EPC with a predefined backhaul network between the RAN and the EPC. We used the `PointToPointEpcHelper`. This `EpcHelper` creates point-to-point links between the eNBs and the SGW.

We now explain how to write a simulation program that allows the simulator user to create any kind of backhaul network in the simulation program.

First of all, in addition to `LteHelper`, you need to use the `NoBackhaulEpcHelper` class, which implements an EPC but without connecting the eNBs with the core network. It just creates the network elements of the core network:

```
Ptr<LteHelper> lteHelper = CreateObject<LteHelper> ();
Ptr<NoBackhaulEpcHelper> epcHelper = CreateObject<NoBackhaulEpcHelper> ();
```

Then, as usual, you need to tell the LTE helper that the EPC will be used:

```
lteHelper->SetEpcHelper (epcHelper);
```

Now, you should create the backhaul network. Here we create point-to-point links as it is done by the `PointToPointEpcHelper`. We assume you have a container for eNB nodes like this:

```
NodeContainer enbNodes;
```

We get the SGW node:

```
Ptr<Node> sgw = epcHelper->GetSgwNode ();
```

And we connect every eNB from the container with the SGW with a point-to-point link. We also assign IPv4 addresses to the interfaces of eNB and SGW with `sluIpv4AddressHelper.Assign (sgwEnbDevices)` and finally we tell the `EpcHelper` that this eNB has a new S1 interface with `epcHelper->AddS1Interface (enb, enbS1uAddress, sgwS1uAddress)`, where `enbS1uAddress` and `sgwS1uAddress` are the IPv4 addresses of the eNB and the SGW, respectively:

```
Ipv4AddressHelper sluIpv4AddressHelper;

// Create networks of the S1 interfaces
sluIpv4AddressHelper.SetBase ("10.0.0.0", "255.255.255.252");

for (uint16_t i = 0; i < enbNodes.GetN (); ++i)
{
    Ptr<Node> enb = enbNodes.Get (i);

    // Create a point to point link between the eNB and the SGW with
    // the corresponding new NetDevices on each side
    PointToPointHelper p2ph;
```

(continues on next page)

(continued from previous page)

```

DataRate sluLinkDataRate = DataRate ("10Gb/s");
uint16_t sluLinkMtu = 2000;
Time sluLinkDelay = Time (0);
p2ph.SetDeviceAttribute ("DataRate", DataRateValue (sluLinkDataRate));
p2ph.SetDeviceAttribute ("Mtu", UIntegerValue (sluLinkMtu));
p2ph.SetChannelAttribute ("Delay", TimeValue (sluLinkDelay));
NetDeviceContainer sgwEnbDevices = p2ph.Install (sgw, enb);

Ipv4InterfaceContainer sgwEnbIpIfaces = sluIpv4AddressHelper.Assign_
↪ (sgwEnbDevices);
sluIpv4AddressHelper.NewNetwork ();

Ipv4Address sgwSluAddress = sgwEnbIpIfaces.GetAddress (0);
Ipv4Address enbSluAddress = sgwEnbIpIfaces.GetAddress (1);

// Create S1 interface between the SGW and the eNB
epcHelper->AddS1Interface (enb, enbSluAddress, sgwSluAddress);
}

```

This is just an example how to create a custom backhaul network. In this other example, we connect all eNBs and the SGW to the same CSMA network:

```

// Create networks of the S1 interfaces
sluIpv4AddressHelper.SetBase ("10.0.0.0", "255.255.255.0");

NodeContainer sgwEnbNodes;
sgwEnbNodes.Add (sgw);
sgwEnbNodes.Add (enbNodes);

Csmahelper csmah;
NetDeviceContainer sgwEnbDevices = csmah.Install (sgwEnbNodes);
Ptr<NetDevice> sgwDev = sgwEnbDevices.Get (0);

Ipv4InterfaceContainer sgwEnbIpIfaces = sluIpv4AddressHelper.Assign (sgwEnbDevices);
Ipv4Address sgwSluAddress = sgwEnbIpIfaces.GetAddress (0);

for (uint16_t i = 0; i < enbNodes.GetN (); ++i)
{
    Ptr<Node> enb = enbNodes.Get (i);
    Ipv4Address enbSluAddress = sgwEnbIpIfaces.GetAddress (i + 1);

    // Create S1 interface between the SGW and the eNB
    epcHelper->AddS1Interface (enb, enbSluAddress, sgwSluAddress);
}

```

As you can see, apart from how you create the backhaul network, i.e. the point-to-point links or the CSMA network, the important point is to tell the `EpcHelper` that an eNB has a new S1 interface.

Now, you should continue configuring your simulation program as it is explained in *Evolved Packet Core (EPC)* subsection. This configuration includes: the internet, installing the LTE eNBs and possibly configuring other LTE aspects, installing the LTE UEs and configuring them as IP nodes, activation of the dedicated EPS bearers and installing applications on the LTE UEs and on the remote hosts.

## 19.2.17 Network Attachment

As shown in the basic example in section *Basic simulation program*, attaching a UE to an eNodeB is done by calling `LteHelper::Attach` function.

There are 2 possible ways of network attachment. The first method is the “*manual*” one, while the second one has a more “*automatic*” sense on it. Each of them will be covered in this section.

### Manual attachment

This method uses the `LteHelper::Attach` function mentioned above. It has been the only available network attachment method in earlier versions of LTE module. It is typically invoked before the simulation begins:

```
lteHelper->Attach (ueDevs, enbDev); // attach one or more UEs to a single eNodeB
```

`LteHelper::InstallEnbDevice` and `LteHelper::InstallUeDevice` functions must have been called before attaching. In an EPC-enabled simulation, it is also required to have IPv4/IPv6 properly pre-installed in the UE.

This method is very simple, but requires you to know exactly which UE belongs to to which eNodeB before the simulation begins. This can be difficult when the UE initial position is randomly determined by the simulation script.

One may choose the distance between the UE and the eNodeB as a criterion for selecting the appropriate cell. It is quite simple (at least from the simulator’s point of view) and sometimes practical. But it is important to note that sometimes distance does not make a single correct criterion. For instance, the eNodeB antenna directivity should be considered as well. Besides that, one should also take into account the channel condition, which might be fluctuating if there is fading or shadowing in effect. In these kind of cases, network attachment should not be based on distance alone.

In real life, UE will automatically evaluate certain criteria and select the best cell to attach to, without manual intervention from the user. Obviously this is not the case in this `LteHelper::Attach` function. The other network attachment method uses more “*automatic*” approach to network attachment, as will be described next.

### Automatic attachment using Idle mode cell selection procedure

The strength of the received signal is the standard criterion used for selecting the best cell to attach to. The use of this criterion is implemented in the *initial cell selection* process, which can be invoked by calling another version of the `LteHelper::Attach` function, as shown below:

```
lteHelper->Attach (ueDevs); // attach one or more UEs to a strongest cell
```

The difference with the manual method is that the destination eNodeB is not specified. The procedure will find the best cell for the UEs, based on several criteria, including the strength of the received signal (RSRP).

After the method is called, the UE will spend some time to measure the neighbouring cells, and then attempt to attach to the best one. More details can be found in section *Initial Cell Selection* of the Design Documentation.

It is important to note that this method only works in EPC-enabled simulations. LTE-only simulations must resort to manual attachment method.

### Closed Subscriber Group

An interesting use case of the initial cell selection process is to setup a simulation environment with Closed Subscriber Group (CSG).



For example, a certain eNodeB, typically a smaller version such as femtocell, might belong to a private owner (e.g. a household or business), allowing access only to some UEs which have been previously registered by the owner. The eNodeB and the registered UEs altogether form a CSG.

The access restriction can be simulated by “labeling” the CSG members with the same CSG ID. This is done through the attributes in both eNodeB and UE, for example using the following `LteHelper` functions:

```
// label the following eNodeBs with CSG identity of 1 and CSG indication enabled
lteHelper->SetEnbDeviceAttribute ("CsgId", UIntegerValue (1));
lteHelper->SetEnbDeviceAttribute ("CsgIndication", BooleanValue (true));

// label one or more UEs with CSG identity of 1
lteHelper->SetUeDeviceAttribute ("CsgId", UIntegerValue (1));

// install the eNodeBs and UEs
NetDeviceContainer csgEnbDevs = lteHelper->InstallEnbDevice (csgEnbNodes);
NetDeviceContainer csgUeDevs = lteHelper->InstallUeDevice (csgUeNodes);
```

Then enable the initial cell selection procedure on the UEs:

```
lteHelper->Attach (csgUeDevs);
```

This is necessary because the CSG restriction only works with automatic method of network attachment, but not in the manual method.

Note that setting the CSG indication of an eNodeB as false (the default value) will disable the restriction, i.e., any UEs can connect to this eNodeB.

## 19.2.18 Configure UE measurements

The active UE measurement configuration in a simulation is dictated by the selected so called “consumers”, such as handover algorithm. Users may add their own configuration into action, and there are several ways to do so:

1. direct configuration in eNodeB RRC entity;
2. configuring existing handover algorithm; and
3. developing a new handover algorithm.

This section will cover the first method only. The second method is covered in *Automatic handover trigger*, while the third method is explained in length in Section *Handover algorithm* of the Design Documentation.

Direct configuration in eNodeB RRC works as follows. User begins by creating a new `LteRrcSap::ReportConfigEutra` instance and pass it to the `LteEnbRrc::AddUeMeasReportConfig` function. The function will return the `measId` (measurement identity) which is a unique reference of the configuration in the eNodeB instance. This function must be called before the simulation begins. The measurement configuration will be active in all UEs attached to the eNodeB throughout the duration of the simulation. During the simulation, user can capture the measurement reports produced by the UEs by listening to the existing `LteEnbRrc::RecvMeasurementReport` trace source.

The structure `ReportConfigEutra` is in accord with 3GPP specification. Definition of the structure and each member field can be found in Section 6.3.5 of [TS36331].

The code sample below configures Event A1 RSRP measurement to every eNodeB within the container `devs`:

```
LteRrcSap::ReportConfigEutra config;
config.eventId = LteRrcSap::ReportConfigEutra::EVENT_A1;
config.threshold1.choice = LteRrcSap::ThresholdEutra::THRESHOLD_RSRP;
config.threshold1.range = 41;
```

(continues on next page)

(continued from previous page)

```

config.triggerQuantity = LteRrcSap::ReportConfigEutra::RSRP;
config.reportInterval = LteRrcSap::ReportConfigEutra::MS480;

std::vector<uint8_t> measIdList;

NetDeviceContainer::Iterator it;
for (it = devs.Begin (); it != devs.End (); it++)
{
    Ptr<NetDevice> dev = *it;
    Ptr<LteEnbNetDevice> enbDev = dev->GetObject<LteEnbNetDevice> ();
    Ptr<LteEnbRrc> enbRrc = enbDev->GetRrc ();

    uint8_t measId = enbRrc->AddUeMeasReportConfig (config);
    measIdList.push_back (measId); // remember the measId created

    enbRrc->TraceConnect ("RecvMeasurementReport",
                          "context",
                          MakeCallback (&RecvMeasurementReportCallback));
}

```

Note that thresholds are expressed as range. In the example above, the range 41 for RSRP corresponds to -100 dBm. The conversion from and to the range format is due to Section 9.1.4 and 9.1.7 of [TS36133]. The `EutranMeasurementMapping` class has several static functions that can be used for this purpose.

The corresponding callback function would have a definition similar as below:

```

void
RecvMeasurementReportCallback (std::string context,
                               uint64_t imsi,
                               uint16_t cellId,
                               uint16_t rnti,
                               LteRrcSap::MeasurementReport measReport);

```

This method will register the callback function as a consumer of UE measurements. In the case where there are more than one consumers in the simulation (e.g. handover algorithm), the measurements intended for other consumers will also be captured by this callback function. Users may utilize the `measId` field, contained within the `LteRrcSap::MeasurementReport` argument of the callback function, to tell which measurement configuration has triggered the report.

In general, this mechanism prevents one consumer to unknowingly intervene with another consumer's reporting configuration.

Note that only the reporting configuration part (i.e. `LteRrcSap::ReportConfigEutra`) of the UE measurements parameter is open for consumers to configure, while the other parts are kept hidden. The intra-frequency limitation is the main motivation behind this API implementation decision:

- there is only one, unambiguous and definitive *measurement object*, thus there is no need to configure it;
- *measurement identities* are kept hidden because of the fact that there is one-to-one mapping between reporting configuration and measurement identity, thus a new measurement identity is set up automatically when a new reporting configuration is created;
- *quantity configuration* is configured elsewhere, see *Performing measurements*; and
- *measurement gaps* are not supported, because it is only applicable for inter-frequency settings;

## 19.2.19 X2-based handover

As defined by 3GPP, handover is a procedure for changing the serving cell of a UE in CONNECTED mode. The two eNodeBs involved in the process are typically called the *source eNodeB* and the *target eNodeB*.

In order to enable the execution of X2-based handover in simulation, there are two requirements that must be met. Firstly, EPC must be enabled in the simulation (see *Evolved Packet Core (EPC)*).

Secondly, an X2 interface must be configured between the two eNodeBs, which needs to be done explicitly within the simulation program:

```
lteHelper->AddX2Interface (enbNodes);
```

where `enbNodes` is a `NodeContainer` that contains the two eNodeBs between which the X2 interface is to be configured. If the container has more than two eNodeBs, the function will create an X2 interface between every pair of eNodeBs in the container.

Lastly, the target eNodeB must be configured as “open” to X2 HANDOVER REQUEST. Every eNodeB is open by default, so no extra instruction is needed in most cases. However, users may set the eNodeB to “closed” by setting the boolean attribute `LteEnbRrc::AdmitHandoverRequest` to *false*. As an example, you can run the `lena-x2-handover` program and setting the attribute in this way:

```
NS_LOG=EpcX2:LteEnbRrc ./waf --run lena-x2-handover --command="%s --
->ns3::LteEnbRrc::AdmitHandoverRequest=false"
```

After the above three requirements are fulfilled, the handover procedure can be triggered manually or automatically. Each will be presented in the following subsections.

### Manual handover trigger

Handover event can be triggered “manually” within the simulation program by scheduling an explicit handover event. The `LteHelper` object provides a convenient method for the scheduling of a handover event. As an example, let us assume that `ueLteDevs` is a `NetDeviceContainer` that contains the UE that is to be handed over, and that `enbLteDevs` is another `NetDeviceContainer` that contains the source and the target eNB. Then, a handover at 0.1s can be scheduled like this:

```
lteHelper->HandoverRequest (Seconds (0.100),
                           ueLteDevs.Get (0),
                           enbLteDevs.Get (0),
                           enbLteDevs.Get (1));
```

Note that the UE needs to be already connected to the source eNB, otherwise the simulation will terminate with an error message.

For an example with full source code, please refer to the `lena-x2-handover` example program.

### Automatic handover trigger

Handover procedure can also be triggered “automatically” by the serving eNodeB of the UE. The logic behind the trigger depends on the handover algorithm currently active in the eNodeB RRC entity. Users may select and configure the handover algorithm that will be used in the simulation, which will be explained shortly in this section. Users may also opt to write their own implementation of handover algorithm, as described in Section *Handover algorithm* of the Design Documentation.

Selecting a handover algorithm is done via the `LteHelper` object and its `SetHandoverAlgorithmType` method as shown below:

```
Ptr<LteHelper> lteHelper = CreateObject<LteHelper> ();  
lteHelper->SetHandoverAlgorithmType ("ns3::A2A4RsrqHandoverAlgorithm");
```

The selected handover algorithm may also provide several configurable attributes, which can be set as follows:

```
lteHelper->SetHandoverAlgorithmAttribute ("ServingCellThreshold",  
                                         UIntegerValue (30));  
lteHelper->SetHandoverAlgorithmAttribute ("NeighbourCellOffset",  
                                         UIntegerValue (1));
```

Three options of handover algorithm are included in the LTE module. The *A2-A4-RSRQ* handover algorithm (named as `ns3::A2A4RsrqHandoverAlgorithm`) is the default option, and the usage has already been shown above.

Another option is the *strongest cell* handover algorithm (named as `ns3::A3RsrpHandoverAlgorithm`), which can be selected and configured by the following code:

```
lteHelper->SetHandoverAlgorithmType ("ns3::A3RsrpHandoverAlgorithm");  
lteHelper->SetHandoverAlgorithmAttribute ("Hysteresis",  
                                         DoubleValue (3.0));  
lteHelper->SetHandoverAlgorithmAttribute ("TimeToTrigger",  
                                         TimeValue (Milliseconds (256)));
```

The last option is a special one, called the *no-op* handover algorithm, which basically disables automatic handover trigger. This is useful for example in cases where manual handover trigger need an exclusive control of all handover decision. It does not have any configurable attributes. The usage is as follows:

```
lteHelper->SetHandoverAlgorithmType ("ns3::NoOpHandoverAlgorithm");
```

For more information on each handover algorithm's decision policy and their attributes, please refer to their respective subsections in Section *Handover algorithm* of the Design Documentation.

Finally, the `InstallEnbDevice` function of `LteHelper` will instantiate one instance of the selected handover algorithm for each eNodeB device. In other words, make sure to select the right handover algorithm before finalizing it in the following line of code:

```
NetDeviceContainer enbLteDevs = lteHelper->InstallEnbDevice (enbNodes);
```

Example with full source code of using automatic handover trigger can be found in the `lena-x2-handover-measures` example program.

## Tuning simulation with handover

As mentioned in the Design Documentation, the current implementation of handover model may produce unpredicted behaviour when handover failure occurs. This subsection will focus on the steps that should be taken into account by users if they plan to use handover in their simulations.

The major cause of handover failure that we will tackle is the error in transmitting handover-related signaling messages during the execution of a handover procedure. As apparent from the Figure *Sequence diagram of the X2-based handover* from the Design Documentation, there are many of them and they use different interfaces and protocols. For the sake of simplicity, we can safely assume that the X2 interface (between the source eNodeB and the target eNodeB) and the S1 interface (between the target eNodeB and the SGW/PGW) are quite stable. Therefore we will focus our attention to the RRC protocol (between the UE and the eNodeBs) and the Random Access procedure, which are normally transmitted through the air and susceptible to degradation of channel condition.

A general tips to reduce transmission error is to *ensure high enough SINR* level in every UE. This can be done by a proper planning of the network topology that *minimizes network coverage hole*. If the topology has a known coverage hole, then the UE should be configured not to venture to that area.

Another approach to keep in mind is to *avoid too-late handovers*. In other words, handover should happen before the UE's SINR becomes too low, otherwise the UE may fail to receive the handover command from the source eNodeB. Handover algorithms have the means to control how early or late a handover decision is made. For example, A2-A4-RSRQ handover algorithm can be configured with a higher threshold to make it decide a handover earlier. Similarly, smaller hysteresis and/or shorter time-to-trigger in the strongest cell handover algorithm typically results in earlier handovers. In order to find the right values for these parameters, one of the factors that should be considered is the UE movement speed. Generally, a faster moving UE requires the handover to be executed earlier. Some research work have suggested recommended values, such as in [Lee2010].

The above tips should be enough in normal simulation uses, but in the case some special needs arise then an extreme measure can be taken into consideration. For instance, users may consider *disabling the channel error models*. This will ensure that all handover-related signaling messages will be transmitted successfully, regardless of distance and channel condition. However, it will also affect all other data or control packets not related to handover, which may be an unwanted side effect. Otherwise, it can be done as follows:

```
Config::SetDefault ("ns3::LteSpectrumPhy::CtrlErrorModelEnabled", BooleanValue_
↳(false));
Config::SetDefault ("ns3::LteSpectrumPhy::DataErrorModelEnabled", BooleanValue_
↳(false));
```

By using the above code, we disable the error model in both control and data channels and in both directions (downlink and uplink). This is necessary because handover-related signaling messages are transmitted using these channels. An exception is when the simulation uses the ideal RRC protocol. In this case, only the Random Access procedure is left to be considered. The procedure consists of control messages, therefore we only need to disable the control channel's error model.

## Handover traces

The RRC model, in particular the `LteEnbRrc` and `LteUeRrc` objects, provide some useful traces which can be hooked up to some custom functions so that they are called upon start and end of the handover execution phase at both the UE and eNB side. As an example, in your simulation program you can declare the following methods:

```
void
NotifyHandoverStartUe (std::string context,
                      uint64_t imsi,
                      uint16_t cellId,
                      uint16_t rnti,
                      uint16_t targetCellId)
{
    std::cout << Simulator::Now ().GetSeconds () << " " << context
              << " UE IMSI " << imsi
              << ": previously connected to CellId " << cellId
              << " with RNTI " << rnti
              << ", doing handover to CellId " << targetCellId
              << std::endl;
}

void
NotifyHandoverEndOkUe (std::string context,
                      uint64_t imsi,
                      uint16_t cellId,
                      uint16_t rnti)
{
    std::cout << Simulator::Now ().GetSeconds () << " " << context
              << " UE IMSI " << imsi
              << ": successful handover to CellId " << cellId
```

(continues on next page)

(continued from previous page)

```

        << " with RNTI " << rnti
        << std::endl;
    }

void
NotifyHandoverStartEnb (std::string context,
                       uint64_t imsi,
                       uint16_t cellId,
                       uint16_t rnti,
                       uint16_t targetCellId)
{
    std::cout << Simulator::Now ().GetSeconds () << " " << context
              << " eNB CellId " << cellId
              << ": start handover of UE with IMSI " << imsi
              << " RNTI " << rnti
              << " to CellId " << targetCellId
              << std::endl;
}

void
NotifyHandoverEndOkEnb (std::string context,
                       uint64_t imsi,
                       uint16_t cellId,
                       uint16_t rnti)
{
    std::cout << Simulator::Now ().GetSeconds () << " " << context
              << " eNB CellId " << cellId
              << ": completed handover of UE with IMSI " << imsi
              << " RNTI " << rnti
              << std::endl;
}

```

Then, you can hook up these methods to the corresponding trace sources like this:

```

Config::Connect ("/NodeList/*/DeviceList/*/LteEnbRrc/HandoverStart",
                MakeCallback (&NotifyHandoverStartEnb));
Config::Connect ("/NodeList/*/DeviceList/*/LteUeRrc/HandoverStart",
                MakeCallback (&NotifyHandoverStartUe));
Config::Connect ("/NodeList/*/DeviceList/*/LteEnbRrc/HandoverEndOk",
                MakeCallback (&NotifyHandoverEndOkEnb));
Config::Connect ("/NodeList/*/DeviceList/*/LteUeRrc/HandoverEndOk",
                MakeCallback (&NotifyHandoverEndOkUe));

```

The example program `src/lte/examples/lena-x2-handover.cc` illustrates how the all above instructions can be integrated in a simulation program. You can run the program like this:

```
./waf --run lena-x2-handover
```

and it will output the messages printed by the custom handover trace hooks. In order additionally visualize some meaningful logging information, you can run the program like this:

```
NS_LOG=LteEnbRrc:LteUeRrc:EpcX2 ./waf --run lena-x2-handover
```

## 19.2.20 Frequency Reuse Algorithms

In this section we will describe how to use Frequency Reuse Algorithms in eNb within LTE simulations. There are two possible ways of configuration. The first approach is the “manual” one, it requires more parameters to be configured, but allow user to configure FR algorithm as he/she needs. The second approach is more “automatic”. It is very convenient, because is the same for each FR algorithm, so user can switch FR algorithm very quickly by changing only type of FR algorithm. One drawback is that “automatic” approach uses only limited set of configurations for each algorithm, what make it less flexible, but is sufficient for most of cases.

These two approaches will be described more in following sub-section.

If user do not configure Frequency Reuse algorithm, default one (i.e. `LteFrNoOpAlgorithm`) is installed in eNb. It acts as if FR algorithm was disabled.

One thing that should be mentioned is that most of implemented FR algorithms work with cell bandwidth greater or equal than 15 RBs. This limitation is caused by requirement that at least three continuous RBs have to be assigned to UE for transmission.

### Manual configuration

Frequency reuse algorithm can be configured “manually” within the simulation program by setting type of FR algorithm and all its attributes. Currently, seven FR algorithms are implemented:

- `ns3::LteFrNoOpAlgorithm`
- `ns3::LteFrHardAlgorithm`
- `ns3::LteFrStrictAlgorithm`
- `ns3::LteFrSoftAlgorithm`
- `ns3::LteFfrSoftAlgorithm`
- `ns3::LteFfrEnhancedAlgorithm`
- `ns3::LteFfrDistributedAlgorithm`

Selecting a FR algorithm is done via the `LteHelper` object and its `SetFfrAlgorithmType` method as shown below:

```
Ptr<LteHelper> lteHelper = CreateObject<LteHelper> ();
lteHelper->SetFfrAlgorithmType ("ns3::LteFrHardAlgorithm");
```

Each implemented FR algorithm provide several configurable attributes. Users do not have to care about UL and DL bandwidth configuration, because it is done automatically during cell configuration. To change bandwidth for FR algorithm, configure required values for `LteEnbNetDevice`:

```
uint8_t bandwidth = 100;
lteHelper->SetEnbDeviceAttribute ("DlBandwidth", UintegerValue (bandwidth));
lteHelper->SetEnbDeviceAttribute ("UlBandwidth", UintegerValue (bandwidth));
```

Now, each FR algorithms configuration will be described.

### Hard Frequency Reuse Algorithm

As described in Section *Hard Frequency Reuse* of the Design Documentation `ns3::LteFrHardAlgorithm` uses one sub-band. To configure this sub-band user need to specify offset and bandwidth for DL and UL in number of RBs.

Hard Frequency Reuse Algorithm provides following attributes:

- `DlSubBandOffset`: Downlink Offset in number of Resource Block Groups

- DlSubBandwidth: Downlink Transmission SubBandwidth Configuration in number of Resource Block Groups
- UlSubBandOffset: Uplink Offset in number of Resource Block Groups
- UlSubBandwidth: Uplink Transmission SubBandwidth Configuration in number of Resource Block Groups

Example configuration of LteFrHardAlgorithm can be done in following way:

```
lteHelper->SetFfrAlgorithmType ("ns3::LteFrHardAlgorithm");
lteHelper->SetFfrAlgorithmAttribute ("DlSubBandOffset", UintegerValue (8));
lteHelper->SetFfrAlgorithmAttribute ("DlSubBandwidth", UintegerValue (8));
lteHelper->SetFfrAlgorithmAttribute ("UlSubBandOffset", UintegerValue (8));
lteHelper->SetFfrAlgorithmAttribute ("UlSubBandwidth", UintegerValue (8));
NetDeviceContainer enbDevs = lteHelper->InstallEnbDevice (enbNodes.Get(0));
```

Above example allow eNB to use only RBs from 8 to 16 in DL and UL, while entire cell bandwidth is 25.

### Strict Frequency Reuse Algorithm

Strict Frequency Reuse Algorithm uses two sub-bands: one common for each cell and one private. There is also RSRQ threshold, which is needed to decide within which sub-band UE should be served. Moreover the power transmission in these sub-bands can be different.

Strict Frequency Reuse Algorithm provides following attributes:

- UlCommonSubBandwidth: Uplink Common SubBandwidth Configuration in number of Resource Block Groups
- UlEdgeSubBandOffset: Uplink Edge SubBand Offset in number of Resource Block Groups
- UlEdgeSubBandwidth: Uplink Edge SubBandwidth Configuration in number of Resource Block Groups
- DlCommonSubBandwidth: Downlink Common SubBandwidth Configuration in number of Resource Block Groups
- DlEdgeSubBandOffset: Downlink Edge SubBand Offset in number of Resource Block Groups
- DlEdgeSubBandwidth: Downlink Edge SubBandwidth Configuration in number of Resource Block Groups
- RsrqThreshold: If the RSRQ of is worse than this threshold, UE should be served in edge sub-band
- CenterPowerOffset: PdschConfigDedicated::Pa value for center sub-band, default value dB0
- EdgePowerOffset: PdschConfigDedicated::Pa value for edge sub-band, default value dB0
- CenterAreaTpc: TPC value which will be set in DL-DCI for UEs in center area, Absolute mode is used, default value 1 is mapped to -1 according to TS36.213 Table 5.1.1.1-2
- EdgeAreaTpc: TPC value which will be set in DL-DCI for UEs in edge area, Absolute mode is used, default value 1 is mapped to -1 according to TS36.213 Table 5.1.1.1-2

Example below allow eNB to use RBs from 0 to 6 as common sub-band and from 12 to 18 as private sub-band in DL and UL, RSRQ threshold is 20 dB, power in center area equals  $LteEnbPhy::TxPower - 3dB$ , power in edge area equals  $LteEnbPhy::TxPower + 3dB$ :

```
lteHelper->SetFfrAlgorithmType ("ns3::LteFrStrictAlgorithm");
lteHelper->SetFfrAlgorithmAttribute ("DlCommonSubBandwidth", UintegerValue (6));
lteHelper->SetFfrAlgorithmAttribute ("UlCommonSubBandwidth", UintegerValue (6));
lteHelper->SetFfrAlgorithmAttribute ("DlEdgeSubBandOffset", UintegerValue (6));
lteHelper->SetFfrAlgorithmAttribute ("DlEdgeSubBandwidth", UintegerValue (6));
lteHelper->SetFfrAlgorithmAttribute ("UlEdgeSubBandOffset", UintegerValue (6));
lteHelper->SetFfrAlgorithmAttribute ("UlEdgeSubBandwidth", UintegerValue (6));
```

(continues on next page)



(continued from previous page)

```

lteHelper->SetFfrAlgorithmAttribute ("RsrqThreshold", UintegerValue (20));
lteHelper->SetFfrAlgorithmAttribute ("CenterPowerOffset",
    UintegerValue (LteRrcSap::PdschConfigDedicated::dB_3));
lteHelper->SetFfrAlgorithmAttribute ("EdgePowerOffset",
    UintegerValue (LteRrcSap::PdschConfigDedicated::dB3));
lteHelper->SetFfrAlgorithmAttribute ("CenterAreaTpc", UintegerValue (1));
lteHelper->SetFfrAlgorithmAttribute ("EdgeAreaTpc", UintegerValue (2));
NetDeviceContainer enbDevs = lteHelper->InstallEnbDevice (enbNodes.Get(0));

```

## Soft Frequency Reuse Algorithm

With Soft Frequency Reuse Algorithm, eNb uses entire cell bandwidth, but there are two sub-bands, within UEs are served with different power level.

Soft Frequency Reuse Algorithm provides following attributes:

- **UlEdgeSubBandOffset**: Uplink Edge SubBand Offset in number of Resource Block Groups
- **UlEdgeSubBandwidth**: Uplink Edge SubBandwidth Configuration in number of Resource Block Groups
- **DlEdgeSubBandOffset**: Downlink Edge SubBand Offset in number of Resource Block Groups
- **DlEdgeSubBandwidth**: Downlink Edge SubBandwidth Configuration in number of Resource Block Groups
- **AllowCenterUeUseEdgeSubBand**: If true center UEs can receive on edge sub-band RBGs, otherwise edge sub-band is allowed only for edge UEs, default value is true
- **RsrqThreshold**: If the RSRQ of is worse than this threshold, UE should be served in edge sub-band
- **CenterPowerOffset**: PdschConfigDedicated::Pa value for center sub-band, default value dB0
- **EdgePowerOffset**: PdschConfigDedicated::Pa value for edge sub-band, default value dB0
- **CenterAreaTpc**: TPC value which will be set in DL-DCI for UEs in center area, Absolute mode is used, default value 1 is mapped to -1 according to TS36.213 Table 5.1.1.1-2
- **EdgeAreaTpc**: TPC value which will be set in DL-DCI for UEs in edge area, Absolute mode is used, default value 1 is mapped to -1 according to TS36.213 Table 5.1.1.1-2

Example below configures RBs from 8 to 16 to be used by cell edge UEs and this sub-band is not available for cell center users. RSRQ threshold is 20 dB, power in center area equals `LteEnbPhy::TxPower`, power in edge area equals `LteEnbPhy::TxPower + 3dB`:

```

lteHelper->SetFfrAlgorithmType ("ns3::LteFrSoftAlgorithm");
lteHelper->SetFfrAlgorithmAttribute ("DlEdgeSubBandOffset", UintegerValue (8));
lteHelper->SetFfrAlgorithmAttribute ("DlEdgeSubBandwidth", UintegerValue (8));
lteHelper->SetFfrAlgorithmAttribute ("UlEdgeSubBandOffset", UintegerValue (8));
lteHelper->SetFfrAlgorithmAttribute ("UlEdgeSubBandwidth", UintegerValue (8));
lteHelper->SetFfrAlgorithmAttribute ("AllowCenterUeUseEdgeSubBand", BooleanValue_
↪ (false));
lteHelper->SetFfrAlgorithmAttribute ("RsrqThreshold", UintegerValue (20));
lteHelper->SetFfrAlgorithmAttribute ("CenterPowerOffset",
    UintegerValue (LteRrcSap::PdschConfigDedicated::dB0));
lteHelper->SetFfrAlgorithmAttribute ("EdgePowerOffset",
    UintegerValue (LteRrcSap::PdschConfigDedicated::dB3));
NetDeviceContainer enbDevs = lteHelper->InstallEnbDevice (enbNodes.Get(0));

```

## Soft Fractional Frequency Reuse Algorithm

Soft Fractional Frequency Reuse (SFFR) uses three sub-bands: center, medium (common) and edge. User have to configure only two of them: common and edge. Center sub-band will be composed from the remaining bandwidth. Each sub-band can be served with different transmission power. Since there are three sub-bands, two RSRQ thresholds needs to be configured.

Soft Fractional Frequency Reuse Algorithm provides following attributes:

- `U1CommonSubBandwidth`: Uplink Common SubBandwidth Configuration in number of Resource Block Groups
- `U1EdgeSubBandOffset`: Uplink Edge SubBand Offset in number of Resource Block Groups
- `U1EdgeSubBandwidth`: Uplink Edge SubBandwidth Configuration in number of Resource Block Groups
- `D1CommonSubBandwidth`: Downlink Common SubBandwidth Configuration in number of Resource Block Groups
- `D1EdgeSubBandOffset`: Downlink Edge SubBand Offset in number of Resource Block Groups
- `D1EdgeSubBandwidth`: Downlink Edge SubBandwidth Configuration in number of Resource Block Groups
- `CenterRsrqThreshold`: If the RSRQ of is worse than this threshold, UE should be served in medium sub-band
- `EdgeRsrqThreshold`: If the RSRQ of is worse than this threshold, UE should be served in edge sub-band
- `CenterAreaPowerOffset`: `PdschConfigDedicated::Pa` value for center sub-band, default value dB0
- `MediumAreaPowerOffset`: `PdschConfigDedicated::Pa` value for medium sub-band, default value dB0
- `EdgeAreaPowerOffset`: `PdschConfigDedicated::Pa` value for edge sub-band, default value dB0
- `CenterAreaTpc`: TPC value which will be set in DL-DCI for UEs in center area, Absolute mode is used, default value 1 is mapped to -1 according to TS36.213 Table 5.1.1.1-2
- `MediumAreaTpc`: TPC value which will be set in DL-DCI for UEs in medium area, Absolute mode is used, default value 1 is mapped to -1 according to TS36.213 Table 5.1.1.1-2
- `EdgeAreaTpc`: TPC value which will be set in DL-DCI for UEs in edge area, Absolute mode is used, default value 1 is mapped to -1 according to TS36.213 Table 5.1.1.1-2

In example below RBs from 0 to 6 will be used as common (medium) sub-band, RBs from 6 to 12 will be used as edge sub-band and RBs from 12 to 24 will be used as center sub-band (it is composed with remaining RBs). RSRQ threshold between center and medium area is 28 dB, RSRQ threshold between medium and edge area is 18 dB. Power in center area equals `LteEnbPhy::TxPower - 3dB`, power in medium area equals `LteEnbPhy::TxPower + 3dB`, power in edge area equals `LteEnbPhy::TxPower + 3dB`:

```
lteHelper->SetFfrAlgorithmType ("ns3::LteFfrSoftAlgorithm");
lteHelper->SetFfrAlgorithmAttribute ("U1CommonSubBandwidth", UintegerValue (6));
lteHelper->SetFfrAlgorithmAttribute ("D1CommonSubBandwidth", UintegerValue (6));
lteHelper->SetFfrAlgorithmAttribute ("D1EdgeSubBandOffset", UintegerValue (0));
lteHelper->SetFfrAlgorithmAttribute ("D1EdgeSubBandwidth", UintegerValue (6));
lteHelper->SetFfrAlgorithmAttribute ("U1EdgeSubBandOffset", UintegerValue (0));
lteHelper->SetFfrAlgorithmAttribute ("U1EdgeSubBandwidth", UintegerValue (6));
lteHelper->SetFfrAlgorithmAttribute ("CenterRsrqThreshold", UintegerValue (28));
lteHelper->SetFfrAlgorithmAttribute ("EdgeRsrqThreshold", UintegerValue (18));
lteHelper->SetFfrAlgorithmAttribute ("CenterAreaPowerOffset",
    UintegerValue (LteRrcSap::PdschConfigDedicated::dB_3));
lteHelper->SetFfrAlgorithmAttribute ("MediumAreaPowerOffset",
    UintegerValue (LteRrcSap::PdschConfigDedicated::dB0));
```

(continues on next page)

(continued from previous page)

```
lteHelper->SetFfrAlgorithmAttribute ("EdgeAreaPowerOffset",
    UIntegerValue (LteRrcSap::PdschConfigDedicated::dB3));
NetDeviceContainer enbDevs = lteHelper->InstallEnbDevice (enbNodes.Get(0));
```

## Enhanced Fractional Frequency Reuse Algorithm

Enhanced Fractional Frequency Reuse (EFFF) reserve part of system bandwidth for each cell (typically there are 3 cell types and each one gets 1/3 of system bandwidth). Then part of this subbandwidth it used as *Primary Segment* with reuse factor 3 and as *Secondary Segment* with reuse factor 1. User has to configure (for DL and UL) offset of the cell subbandwidth in number of RB, number of RB which will be used as *Primary Segment* and number of RB which will be used as *Secondary Segment*. *Primary Segment* is used by cell at will, but RBs from *Secondary Segment* can be assigned to UE only is CQI feedback from this UE have higher value than configured CQI threshold. UE is considered as edge UE when its RSRQ is lower than `RsrqThreshold`.

Since each eNb needs to know where are Primary and Secondary of other cell types, it will calculate them assuming configuration is the same for each cell and only subbandwidth offsets are different. So it is important to divide available system bandwidth equally to each cell and apply the same configuration of Primary and Secondary Segments to them.

Enhanced Fractional Frequency Reuse Algorithm provides following attributes:

- `U1SubBandOffset`: Uplink SubBand Offset for this cell in number of Resource Block Groups
- `U1Reuse3SubBandwidth`: Uplink Reuse 3 SubBandwidth Configuration in number of Resource Block Groups
- `U1Reuse1SubBandwidth`: Uplink Reuse 1 SubBandwidth Configuration in number of Resource Block Groups
- `D1SubBandOffset`: Downlink SubBand Offset for this cell in number of Resource Block Groups
- `D1Reuse3SubBandwidth`: Downlink Reuse 3 SubBandwidth Configuration in number of Resource Block Groups
- `D1Reuse1SubBandwidth`: Downlink Reuse 1 SubBandwidth Configuration in number of Resource Block Groups
- `RsrqThreshold`: If the RSRQ of is worse than this threshold, UE should be served in edge sub-band
- `CenterAreaPowerOffset`: `PdschConfigDedicated::Pa` value for center sub-band, default value dB0
- `EdgeAreaPowerOffset`: `PdschConfigDedicated::Pa` value for edge sub-band, default value dB0
- `D1CqiThreshold`: If the DL-CQI for RBG of is higher than this threshold, transmission on RBG is possible
- `U1CqiThreshold`: If the UL-CQI for RBG of is higher than this threshold, transmission on RBG is possible
- `CenterAreaTpc`: TPC value which will be set in DL-DCI for UEs in center area, Absolute mode is used, default value 1 is mapped to -1 according to TS36.213 Table 5.1.1.1-2
- `EdgeAreaTpc`: TPC value which will be set in DL-DCI for UEs in edge area, Absolute mode is used, default value 1 is mapped to -1 according to TS36.213 Table 5.1.1.1-2

In example below offset in DL and UL is 0 RB, 4 RB will be used in *Primary Segment* and *Secondary Segment*. RSRQ threshold between center and edge area is 25 dB. DL and UL CQI thresholds are set to value of 10. Power in center area equals `LteEnbPhy::TxPower - 6dB`, power in edge area equals `LteEnbPhy::TxPower + 0dB`:

```
lteHelper->SetFfrAlgorithmType ("ns3::LteFfrEnhancedAlgorithm");
lteHelper->SetFfrAlgorithmAttribute ("RsrqThreshold", UIntegerValue (25));
lteHelper->SetFfrAlgorithmAttribute ("D1CqiThreshold", UIntegerValue (10));
lteHelper->SetFfrAlgorithmAttribute ("U1CqiThreshold", UIntegerValue (10));
lteHelper->SetFfrAlgorithmAttribute ("CenterAreaPowerOffset",
```

(continues on next page)

(continued from previous page)

```

        UIntegerValue (LteRrcSap::PdschConfigDedicated::dB_6));
lteHelper->SetFfrAlgorithmAttribute("EdgeAreaPowerOffset",
        UIntegerValue (LteRrcSap::PdschConfigDedicated::dB0));
lteHelper->SetFfrAlgorithmAttribute("UlSubBandOffset", UIntegerValue (0));
lteHelper->SetFfrAlgorithmAttribute("UlReuse3SubBandwidth", UIntegerValue (4));
lteHelper->SetFfrAlgorithmAttribute("UlReuse1SubBandwidth", UIntegerValue (4));
lteHelper->SetFfrAlgorithmAttribute("DlSubBandOffset", UIntegerValue (0));
lteHelper->SetFfrAlgorithmAttribute("DlReuse3SubBandwidth", UIntegerValue (4));
lteHelper->SetFfrAlgorithmAttribute("DlReuse1SubBandwidth", UIntegerValue (4));

```

## Distributed Fractional Frequency Reuse Algorithm

Distributed Fractional Frequency Reuse requires X2 interface between all eNB to be installed. X2 interfaces can be installed only when EPC is configured, so this FFR scheme can be used only with EPC scenarios.

With Distributed Fractional Frequency Reuse Algorithm, eNB uses entire cell bandwidth and there can be two sub-bands: center sub-band and edge sub-band. Within these sub-bands UEs can be served with different power level. Algorithm adaptively selects RBs for cell-edge sub-band on basis of coordination information (i.e. RNTP) from adjacent cells and notifies the base stations of the adjacent cells, which RBs it selected to use in edge sub-band. If there are no UE classified as edge UE in cell, eNB will not use any RBs as edge sub-band.

Distributed Fractional Frequency Reuse Algorithm provides following attributes:

- **CalculationInterval:** Time interval between calculation of Edge sub-band, Default value 1 second
- **RsrqThreshold:** If the RSRQ of is worse than this threshold, UE should be served in edge sub-band
- **RsrpDifferenceThreshold:** If the difference between the power of the signal received by UE from the serving cell and the power of the signal received from the adjacent cell is less than a RsrpDifferenceThreshold value, the cell weight is incremented
- **CenterPowerOffset:** PdschConfigDedicated::Pa value for edge sub-band, default value dB0
- **EdgePowerOffset:** PdschConfigDedicated::Pa value for edge sub-band, default value dB0
- **EdgeRbNum:** Number of RB that can be used in edge sub-band
- **CenterAreaTpc:** TPC value which will be set in DL-DCI for UEs in center area, Absolute mode is used, default value 1 is mapped to -1 according to TS36.213 Table 5.1.1.1-2
- **EdgeAreaTpc:** TPC value which will be set in DL-DCI for UEs in edge area, Absolute mode is used, default value 1 is mapped to -1 according to TS36.213 Table 5.1.1.1-2

In example below calculation interval is 500 ms. RSRQ threshold between center and edge area is 25. RSRP Difference Threshold is set to be 5. In DL and UL 6 RB will be used by each cell in edge sub-band. Power in center area equals  $LteEnbPhy::TxPower - 0dB$ , power in edge area equals  $LteEnbPhy::TxPower + 3dB$ :

```

lteHelper->SetFfrAlgorithmType("ns3::LteFfrDistributedAlgorithm");
lteHelper->SetFfrAlgorithmAttribute("CalculationInterval",
↳TimeValue (Milliseconds (500)));
lteHelper->SetFfrAlgorithmAttribute ("RsrqThreshold", UIntegerValue (25));
lteHelper->SetFfrAlgorithmAttribute ("RsrpDifferenceThreshold", UIntegerValue (5));
lteHelper->SetFfrAlgorithmAttribute ("EdgeRbNum", UIntegerValue (6));
lteHelper->SetFfrAlgorithmAttribute ("CenterPowerOffset",
        UIntegerValue (LteRrcSap::PdschConfigDedicated::dB0));
lteHelper->SetFfrAlgorithmAttribute ("EdgePowerOffset",
        UIntegerValue (LteRrcSap::PdschConfigDedicated::dB3));

```

## Automatic configuration

Frequency Reuse algorithms can also be configured in more “automatic” way by setting only the bandwidth and FrCellTypeId. During initialization of FR instance, configuration for set bandwidth and FrCellTypeId will be taken from configuration table. It is important that only sub-bands will be configured, thresholds and transmission power will be set to default values. If one wants, he/she can change thresholds and transmission power as show in previous sub-section.

There are three FrCellTypeId : 1, 2, 3, which correspond to three different configurations for each bandwidth. Three configurations allow to have different configurations in neighbouring cells in hexagonal eNB layout. If user needs to have more different configuration for neighbouring cells, he/she need to use manual configuration.

Example below show automatic FR algorithm configuration:

```
lteHelper->SetFfrAlgorithmType("ns3::LteFfrSoftAlgorithm");
lteHelper->SetFfrAlgorithmAttribute("FrCellTypeId", UintegerValue (1));
NetDeviceContainer enbDevs = lteHelper->InstallEnbDevice (enbNodes.Get(0));
```

### 19.2.21 Uplink Power Control

Uplink Power Control functionality is enabled by default. User can disable it by setting the boolean attribute ns3::LteUePhy::EnableUplinkPowerControl to true.

User can switch between Open Loop Power Control and Closed Loop Power Control mechanisms by setting the boolean attribute ns3::LteUePowerControl::ClosedLoop. By default Closed Loop Power Control with Accumulation Mode is enabled.

Path-loss is key component of Uplink Power Control. It is computed as difference between filtered RSRP and ReferenceSignalPower parameter. ReferenceSignalPower is sent with SIB2.

Attributes available in Uplink Power Control:

- ClosedLoop: if true Closed Loop Uplink Power Control mode is enabled and Open Loop Power Control otherwise, default value is false
- AccumulationEnabled: if true Accumulation Mode is enabled and Absolute mode otherwise, default value is false
- Alpha: the path loss compensation factor, default value is 1.0
- P<sub>cmin</sub>: minimal UE TxPower, default value is -40 dBm
- P<sub>cmax</sub>: maximal UE TxPower, default value is 23 dBm
- P<sub>oNominalPusch</sub>: this parameter should be set by higher layers, but currently it needs to be configured by attribute system, possible values are integers in range (-126 ... 24), Default value is -80
- P<sub>oUePusch</sub>: this parameter should be set by higher layers, but currently it needs to be configured by attribute system, possible values are integers in range (-8 ... 7), Default value is 0
- P<sub>srsOffset</sub>: this parameter should be set by higher layers, but currently it needs to be configured by attribute system, possible values are integers in range (0 ... 15), Default value is 7, what gives P<sub>Srs\_Offset\_Value</sub> = 0

**Traced values in Uplink Power Control:**

- ReportPuschTxPower: Current UE TxPower for PUSCH
- ReportPucchTxPower: Current UE TxPower for PUCCH
- ReportSrsTxPower: Current UE TxPower for SRS

Example configuration is presented below:

```
Config::SetDefault ("ns3::LteUePhy::EnableUplinkPowerControl", BooleanValue (true));
Config::SetDefault ("ns3::LteEnbPhy::TxPower", DoubleValue (30));
Config::SetDefault ("ns3::LteUePowerControl::ClosedLoop", BooleanValue (true));
Config::SetDefault ("ns3::LteUePowerControl::AccumulationEnabled", BooleanValue_
↳(true));
```

As an example, user can take a look and run the `lena-uplink-power-control` program.

## 19.2.22 Examples Programs

The directory `src/lte/examples/` contains some example simulation programs that show how to simulate different LTE scenarios.

## 19.2.23 Reference scenarios

There is a vast amount of reference LTE simulation scenarios which can be found in the literature. Here we list some of them:

- The system simulation scenarios mentioned in section A.2 of [TR36814].
- The dual stripe model [R4-092042], which is partially implemented in the example program `src/lte/examples/lena-dual-stripe.cc`. This example program features a lot of configurable parameters which can be customized by changing the corresponding global variables. To get a list of all these global variables, you can run this command:

```
./waf --run lena-dual-stripe --command-template="%s --PrintGlobals"
```

The following subsection presents an example of running a simulation campaign using this example program.

### Handover simulation campaign

In this subsection, we will demonstrate an example of running a simulation campaign using the LTE module of *ns-3*. The objective of the campaign is to compare the effect of each built-in handover algorithm of the LTE module.

The campaign will use the `lena-dual-stripe` example program. First, we have to modify the example program to produce the output that we need. In this occasion, we want to produce the number of handovers, user average throughput, and average SINR.

The number of handovers can be obtained by counting the number of times the *HandoverEndOk Handover traces* is fired. Then the user average throughput can be obtained by enabling the RLC *Simulation Output*. Finally, SINR can be obtained by enabling the PHY simulation output. The following sample code snippet shows one possible way to obtain the above:

```
void
NotifyHandoverEndOkUe (std::string context, uint64_t imsi,
                      uint16_t cellId, uint16_t rnti)
{
    std::cout << "Handover IMSI " << imsi << std::endl;
}

int
main (int argc, char *argv[])
{
    /*** SNIP ***/
```

(continues on next page)

(continued from previous page)

```

Config::Connect ("/NodeList/*/DeviceList/*/LteUeRrc/HandoverEndOk",
                MakeCallback (&NotifyHandoverEndOkUe));

lteHelper->EnablePhyTraces ();
lteHelper->EnableRlcTraces ();
Ptr<RadioBearerStatsCalculator> rlcStats = lteHelper->GetRlcStats ();
rlcStats->SetAttribute ("StartTime", TimeValue (Seconds (0)));
rlcStats->SetAttribute ("EpochDuration", TimeValue (Seconds (simTime)));

Simulator::Run ();
Simulator::Destroy ();
return 0;
}

```

Then we have to configure the parameters of the program to suit our simulation needs. We are looking for the following assumptions in our simulation:

- 7 sites of tri-sector macro eNodeBs (i.e. 21 macrocells) deployed in hexagonal layout with 500 m inter-site distance.
- Although `lena-dual-stripe` is originally intended for a two-tier (macrocell and femtocell) simulation, we will simplify our simulation to one-tier (macrocell) simulation only.
- UEs are randomly distributed around the sites and attach to the network automatically using Idle mode cell selection. After that, UE will roam the simulation environment with 60 kmph movement speed.
- 50 seconds simulation duration, so UEs would have traveled far enough to trigger some handovers.
- 46 dBm macrocell Tx power and 10 dBm UE Tx power.
- EPC mode will be used because the X2 handover procedure requires it to be enabled.
- Full-buffer downlink and uplink traffic, both in 5 MHz bandwidth, using TCP protocol and Proportional Fair scheduler.
- Ideal RRC protocol.

Table *lena-dual-stripe parameter configuration for handover campaign* below shows how we configure the parameters of `lena-dual-stripe` to achieve the above assumptions.

Table 4: `lena-dual-stripe` parameter configuration for handover campaign

Parameter name	Value	Description
<code>simTime</code>	50	50 seconds simulation duration
<code>nBlocks</code>	0	Disabling apartment buildings and femtocells
<code>nMacroEnbSites</code>	7	Number of macrocell sites (each site has 3 cells)
<code>nMacroEnbSitesX</code>	2	The macrocell sites will be positioned in a 2-3-2 formation
<code>interSiteDistance</code>	500	500 m distance between adjacent macrocell sites
<code>macroEnbTxPowerDbm</code>	46	46 dBm Tx power for each macrocell
<code>epc</code>	1	Enable EPC mode
<code>epcDl</code>	1	Enable full-buffer DL traffic
<code>epcUl</code>	1	Enable full-buffer UL traffic
<code>useUdp</code>	0	Disable UDP traffic and enable TCP instead
<code>macroUeDensity</code>	0.00002	Determines number of UEs (translates to 48 UEs in our simulation)
<code>outdoorUeMinSpeed</code>	16.6667	Minimum UE movement speed in m/s (60 kmph)
<code>outdoorUeMaxSpeed</code>	16.6667	Maximum UE movement speed in m/s (60 kmph)
<code>macroEnbBandwidth</code>	25	5 MHz DL and UL bandwidth
<code>generateRem</code>	1	(Optional) For plotting the Radio Environment Map

Some of the required assumptions are not available as parameters of `lena-dual-stripe`. In this case, we override the default attributes, as shown in Table *Overriding default attributes for handover campaign* below.

Table 5: Overriding default attributes for handover campaign

Default value name	Value	Description
<code>ns3::LteHelper::HandoverAlgorithm</code>	<code>ns3::NoOpHandoverAlgorithm,</code> <code>ns3::A3RsrpHandoverAlgorithm,</code> <code>ns3::A2A4RsrqHandoverAlgorithm</code> or	Choice of handover algorithm
<code>ns3::LteHelper::Scheduler</code>	<code>ns3::PffFMacScheduler</code>	Proportional Fair scheduler
<code>ns3::LteHelper::UseIdealRrc</code>	1	Ideal RRC protocol
<code>ns3::RadioBearerStatsCalculator::DlRlcOutputFilename</code>	<code>no-op-DlRlcStats.txt</code>	File name for DL RLC trace output
<code>ns3::RadioBearerStatsCalculator::UlRlcOutputFilename</code>	<code>no-op-UlRlcStats.txt</code>	File name for UL RLC trace output
<code>ns3::PhyStatsCalculator::DlRsrpSinrFilename</code>	<code>no-op-DlRsrpSinrStats.txt</code>	File name for DL PHY RSRP/SINR trace output
<code>ns3::PhyStatsCalculator::UlSinrFilename</code>	<code>no-op-UlSinrStats.txt</code>	File name for UL PHY SINR trace output

`ns-3` provides many ways for passing configuration values into a simulation. In this example, we will use the command line arguments. It is basically done by appending the parameters and their values to the `waf` call when starting each individual simulation. So the `waf` calls for invoking our 3 simulations would look as below:

```
$ ./waf --run="lena-dual-stripe
--simTime=50 --nBlocks=0 --nMacroEnbSites=7 --nMacroEnbSitesX=2
--epc=1 --useUdp=0 --outdoorUeMinSpeed=16.6667 --outdoorUeMaxSpeed=16.6667
--ns3::LteHelper::HandoverAlgorithm=ns3::NoOpHandoverAlgorithm
--ns3::RadioBearerStatsCalculator::DlRlcOutputFilename=no-op-DlRlcStats.txt
--ns3::RadioBearerStatsCalculator::UlRlcOutputFilename=no-op-UlRlcStats.txt
--ns3::PhyStatsCalculator::DlRsrpSinrFilename=no-op-DlRsrpSinrStats.txt
--ns3::PhyStatsCalculator::UlSinrFilename=no-op-UlSinrStats.txt
--RngRun=1" > no-op.txt
```

(continues on next page)



(continued from previous page)

```

$ ./waf --run="lena-dual-stripe
--simTime=50 --nBlocks=0 --nMacroEnbSites=7 --nMacroEnbSitesX=2
--epc=1 --useUdp=0 --outdoorUeMinSpeed=16.6667 --outdoorUeMaxSpeed=16.6667
--ns3::LteHelper::HandoverAlgorithm=ns3::A3RsrpHandoverAlgorithm
--ns3::RadioBearerStatsCalculator::DlRlcOutputFilename=a3-rsrp-DlRlcStats.txt
--ns3::RadioBearerStatsCalculator::UlRlcOutputFilename=a3-rsrp-UlRlcStats.txt
--ns3::PhyStatsCalculator::DlRsrpSinrFilename=a3-rsrp-DlRsrpSinrStats.txt
--ns3::PhyStatsCalculator::UlSinrFilename=a3-rsrp-UlSinrStats.txt
--RngRun=1" > a3-rsrp.txt

$ ./waf --run="lena-dual-stripe
--simTime=50 --nBlocks=0 --nMacroEnbSites=7 --nMacroEnbSitesX=2
--epc=1 --useUdp=0 --outdoorUeMinSpeed=16.6667 --outdoorUeMaxSpeed=16.6667
--ns3::LteHelper::HandoverAlgorithm=ns3::A2A4RsrqHandoverAlgorithm
--ns3::RadioBearerStatsCalculator::DlRlcOutputFilename=a2-a4-rsrq-DlRlcStats.txt
--ns3::RadioBearerStatsCalculator::UlRlcOutputFilename=a2-a4-rsrq-UlRlcStats.txt
--ns3::PhyStatsCalculator::DlRsrpSinrFilename=a2-a4-rsrq-DlRsrpSinrStats.txt
--ns3::PhyStatsCalculator::UlSinrFilename=a2-a4-rsrq-UlSinrStats.txt
--RngRun=1" > a2-a4-rsrq.txt

```

Some notes on the execution:

- Notice that some arguments are not specified because they are already the same as the default values. We also keep the handover algorithms on each own default settings.
- Note the file names of simulation output, e.g. RLC traces and PHY traces, because we have to make sure that they are not overwritten by the next simulation run. In this example, we specify the names one by one using the command line arguments.
- The `--RngRun=1` argument at the end is used for setting the run number used by the random number generator used in the simulation. We re-run the same simulations with different *RngRun* values, hence creating several independent replications of the same simulations. Then we average the results obtained from these replications to achieve some statistical confidence.
- We can add a `--generateRem=1` argument to generate the files necessary for generating the Radio Environment Map (REM) of the simulation. The result is Figure *REM obtained from a simulation in handover campaign* below, which can be produced by following the steps described in Section *Radio Environment Maps*. This figure also shows the position of eNodeBs and UEs at the beginning of a simulation using `RngRun = 1`. Other values of *RngRun* may produce different UE position.

After hours of running, the simulation campaign will eventually end. Next we will perform some post-processing on the produced simulation output to obtain meaningful information out of it.

In this example, we use GNU Octave to assist the processing of throughput and SINR data, as demonstrated in a sample GNU Octave script below:

```

% RxBytes is the 10th column
DlRxBytes = load ("no-op-DlRlcStats.txt") (:,10);
DlAverageThroughputKbps = sum (DlRxBytes) * 8 / 1000 / 50

% RxBytes is the 10th column
UlRxBytes = load ("no-op-UlRlcStats.txt") (:,10);
UlAverageThroughputKbps = sum (UlRxBytes) * 8 / 1000 / 50

% Sinr is the 6th column
DlSinr = load ("no-op-DlRsrpSinrStats.txt") (:,6);
% eliminate NaN values

```

(continues on next page)

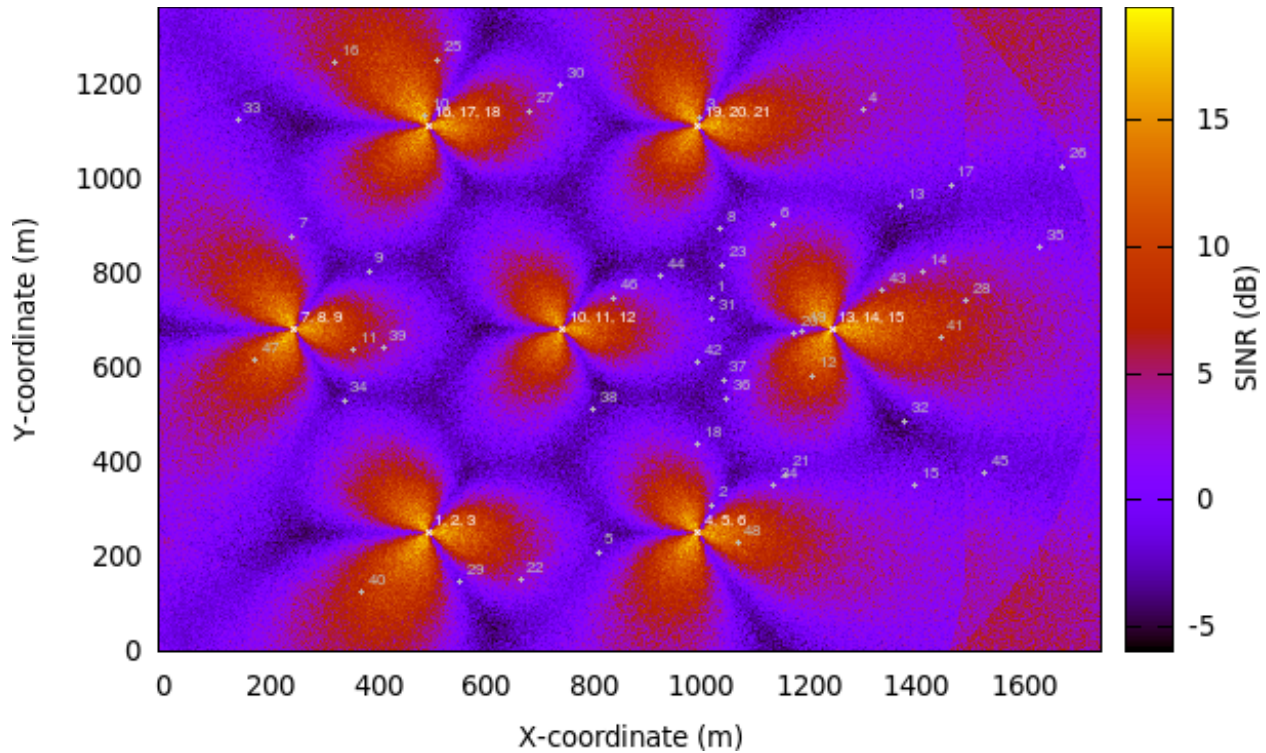

Fig. 75: REM obtained from a simulation in handover campaign

(continued from previous page)

```

idx = isnan (DlSinr);
DlSinr (idx) = 0;
DlAverageSinrDb = 10 * log10 (mean (DlSinr)) % convert to dB

% Sinr is the 5th column
UlSinr = load ("no-op-UlSinrStats.txt") (:,5);
% eliminate NaN values
idx = isnan (UlSinr);
UlSinr (idx) = 0;
UlAverageSinrDb = 10 * log10 (mean (UlSinr)) % convert to dB

```

As for the number of handovers, we can use simple shell scripting to count the number of occurrences of string “Handover” in the log file:

```
$ grep "Handover" no-op.txt | wc -l
```

Table *Results of handover campaign* below shows the complete statistics after we are done with post-processing on every individual simulation run. The values shown are the average of the results obtained from `RngRun` of 1, 2, 3, and 4.

Table 6: Results of handover campaign

Statistics	No-op	A2-A4-RSRQ	Strongest cell
Average DL system throughput	6 615 kbps	20 509 kbps	19 709 kbps
Average UL system throughput	4 095 kbps	5 705 kbps	6 627 kbps
Average DL SINR	-0.10 dB	5.19 dB	5.24 dB
Average UL SINR	9.54 dB	81.57 dB	79.65 dB
Number of handovers per UE per second	0	0.05694	0.04771

The results show that having a handover algorithm in a mobility simulation improves both user throughput and SINR significantly. There is little difference between the two handover algorithms in this campaign scenario. It would be interesting to see their performance in different scenarios, such as scenarios with home eNodeBs deployment.

### Frequency Reuse examples

There are two examples showing Frequency Reuse Algorithms functionality.

`lena-frequency-reuse` is simple example with 3 eNBs in triangle layout. There are 3 cell edge UEs, which are located in the center of this triangle and 3 cell center UEs (one near each eNB). User can also specify the number of randomly located UEs. FR algorithm is installed in eNBs and each eNB has different `FrCellTypeId`, what means each eNB uses different FR configuration. User can run `lena-frequency-reuse` with 6 different FR algorithms: NoOp, Hard FR, Strict FR, Soft FR, Soft FFR and Enhanced FFR. To run scenario with Distributed FFR algorithm, user should use `lena-distributed-ffr`. These two examples are very similar, but they were split because Distributed FFR requires EPC to be used, and other algorithms do not.

To run `lena-frequency-reuse` with different Frequency Reuse algorithms, user needs to specify FR algorithm by overriding the default attribute `ns3::LteHelper::FfrAlgorithm`. Example command to run `lena-frequency-reuse` with Soft FR algorithm is presented below:

```
$ ./waf --run "lena-frequency-reuse --
↳ns3::LteHelper::FfrAlgorithm=ns3::LteFrSoftAlgorithm"
```

In these examples functionality to generate REM and spectrum analyzer trace was added. User can enable generation of it by setting `generateRem` and `generateSpectrumTrace` attributes.

Command to generate REM for RB 1 in data channel from `lena-frequency-reuse` scenario with Soft FR algorithm is presented below:

```
$ ./waf --run "lena-frequency-reuse --
↳ns3::LteHelper::FfrAlgorithm=ns3::LteFrSoftAlgorithm
  --generateRem=true --remRbId=1"
```

Radio Environment Map for Soft FR is presented in Figure *REM for RB 1 obtained from lena-frequency-reuse example with Soft FR algorithm enabled*.

Command to generate spectrum trace from `lena-frequency-reuse` scenario with Soft FFR algorithm is presented below (Spectrum Analyzer position needs to be configured inside script):

```
$ ./waf --run "lena-frequency-reuse --
↳ns3::LteHelper::FfrAlgorithm=ns3::LteFfrSoftAlgorithm
  --generateSpectrumTrace=true"
```

Example spectrum analyzer trace is presented in figure *Spectrum Analyzer trace obtained from lena-frequency-reuse example with Soft FFR algorithm enabled*. *Spectrum Analyzer was located need eNB with FrCellTypeId 2..* As can be seen, different data channel subbands are sent with different power level (according to configuration), while control channel is transmitted with uniform power along entire system bandwidth.

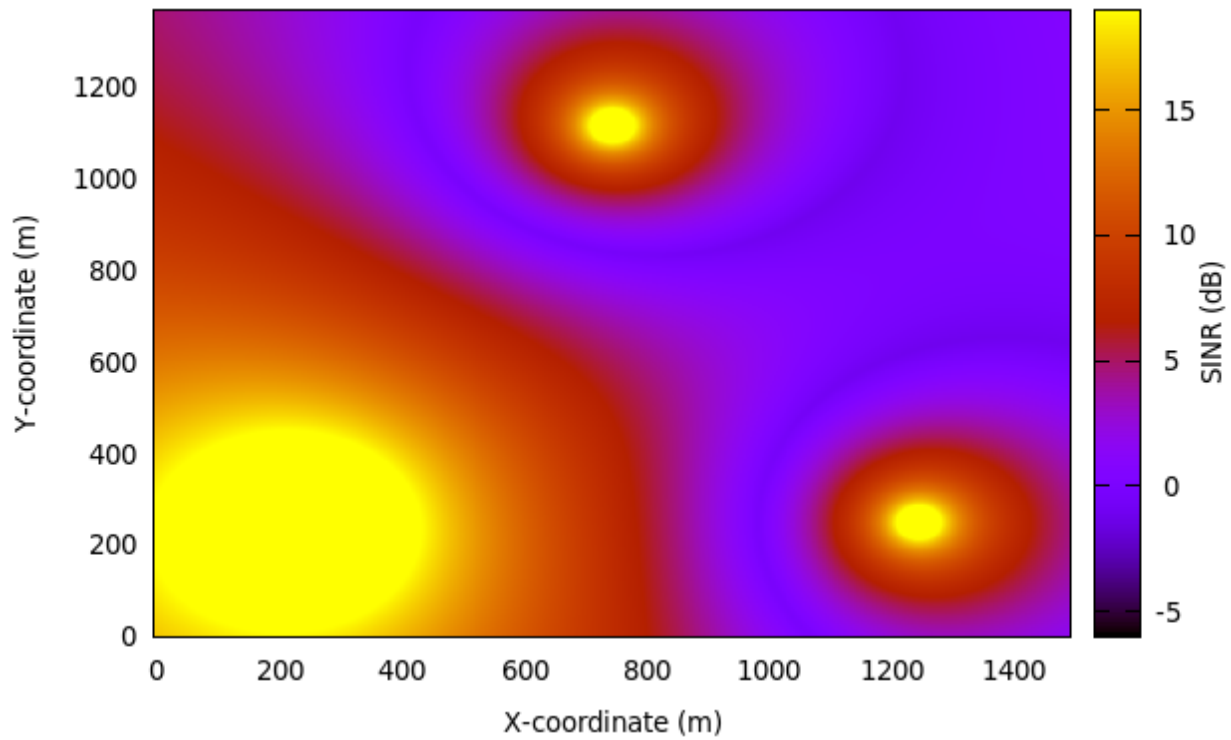

Fig. 76: REM for RB 1 obtained from `lena-frequency-reuse` example with Soft FR algorithm enabled

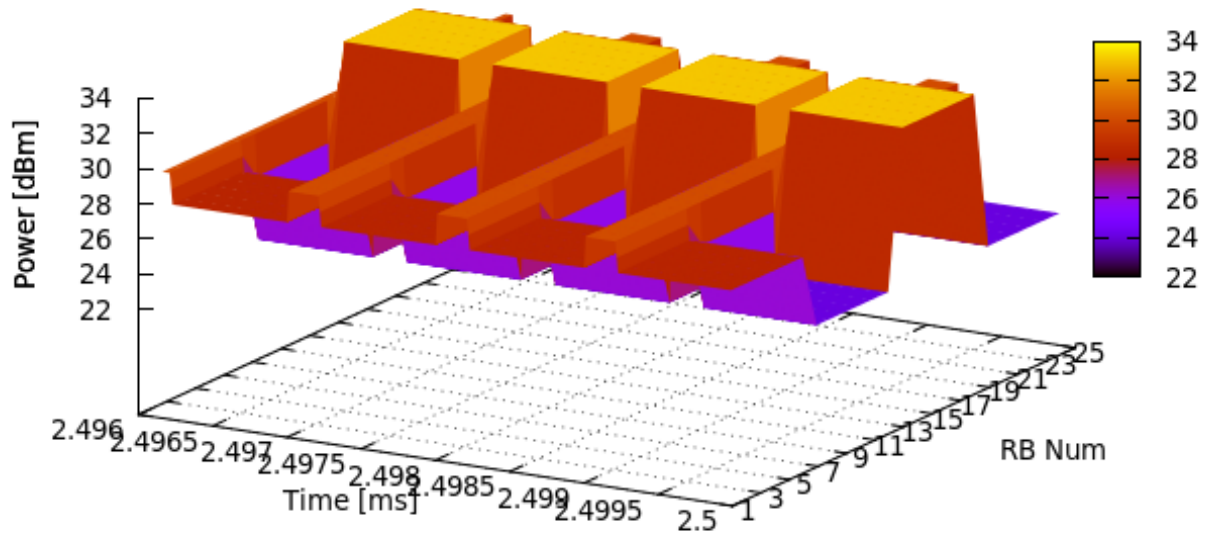

Fig. 77: Spectrum Analyzer trace obtained from `lena-frequency-reuse` example with Soft FFR algorithm enabled. Spectrum Analyzer was located near eNB with `FrCellTypeId 2`.

lena-dual-stripe can be also run with Frequency Reuse algorithms installed in all macro eNB. User needs to specify FR algorithm by overriding the default attribute `ns3::LteHelper::FfrAlgorithm`. Example command to run lena-dual-stripe with Hard FR algorithm is presented below:

```
$ ./waf --run="lena-dual-stripe
--simTime=50 --nBlocks=0 --nMacroEnbSites=7 --nMacroEnbSitesX=2
--epc=1 --useUdp=0 --outdoorUeMinSpeed=16.6667 --outdoorUeMaxSpeed=16.6667
--ns3::LteHelper::HandoverAlgorithm=ns3::NoOpHandoverAlgorithm
--ns3::LteHelper::FfrAlgorithm=ns3::LteFrHardAlgorithm
--ns3::RadioBearerStatsCalculator::DlRlcOutputFilename=no-op-DlRlcStats.txt
--ns3::RadioBearerStatsCalculator::UlRlcOutputFilename=no-op-UlRlcStats.txt
--ns3::PhyStatsCalculator::DlRsrpSinrFilename=no-op-DlRsrpSinrStats.txt
--ns3::PhyStatsCalculator::UlSinrFilename=no-op-UlSinrStats.txt
--RngRun=1" > no-op.txt
```

Example command to generate REM for RB 1 in data channel from lena-dual-stripe scenario with Hard FR algorithm is presented below:

```
$ ./waf --run="lena-dual-stripe
--simTime=50 --nBlocks=0 --nMacroEnbSites=7 --nMacroEnbSitesX=2
--epc=0 --useUdp=0 --outdoorUeMinSpeed=16.6667 --outdoorUeMaxSpeed=16.6667
--ns3::LteHelper::HandoverAlgorithm=ns3::NoOpHandoverAlgorithm
--ns3::LteHelper::FfrAlgorithm=ns3::LteFrHardAlgorithm
--ns3::RadioBearerStatsCalculator::DlRlcOutputFilename=no-op-DlRlcStats.txt
--ns3::RadioBearerStatsCalculator::UlRlcOutputFilename=no-op-UlRlcStats.txt
--ns3::PhyStatsCalculator::DlRsrpSinrFilename=no-op-DlRsrpSinrStats.txt
--ns3::PhyStatsCalculator::UlSinrFilename=no-op-UlSinrStats.txt
--RngRun=1 --generateRem=true --remRbId=1" > no-op.txt
```

Radio Environment Maps for RB 1, 10 and 20 generated from lena-dual-stripe scenario with Hard Frequency Reuse algorithm are presented in the figures below. These RB were selected because each one is used by different FR cell type.

## 19.2.24 Carrier aggregation examples

The carrier aggregation feature is not enabled by default. The user can enable it by setting the boolean attribute `ns3::LteHelper::UseCa` to true. The number of component carriers to be used in carrier aggregation can be configured by setting the attribute `ns3::LteHelper::NumberOfComponentCarriers`. Currently the maximum number is 5. Additionally, the component carrier manager needs to be configured. By default the `NoOpComponentCarrierManager` is selected, which means that only the primary carrier is enabled. The Component carrier manager (CCM) implementation that uses all the available carriers is `RrComponentCarrierManager`. The CCM can be configured by using the attribute `LteHelper::EnbComponentCarrierManager`.

An example configuration is presented below:

```
Config::SetDefault ("ns3::LteHelper::UseCa", BooleanValue (useCa));
Config::SetDefault ("ns3::LteHelper::NumberOfComponentCarriers", UIntegerValue (2));
Config::SetDefault ("ns3::LteHelper::EnbComponentCarrierManager", StringValue (
↪ "ns3::RrComponentCarrierManager"));
```

As an example, the user can take a look and run the `lena-simple` and `lena-simple-epc` programs and enable LTE traces to check the performance. A new column is added to PHY and MAC traces to indicate the component carrier.

The test suite `lte-carrier-aggregation` is also a test program that can be used as an example as it can be run in a mode to write results to output files by setting the `s_writeResults` boolean static variable to true. The test can be run by using a *test-runner*:

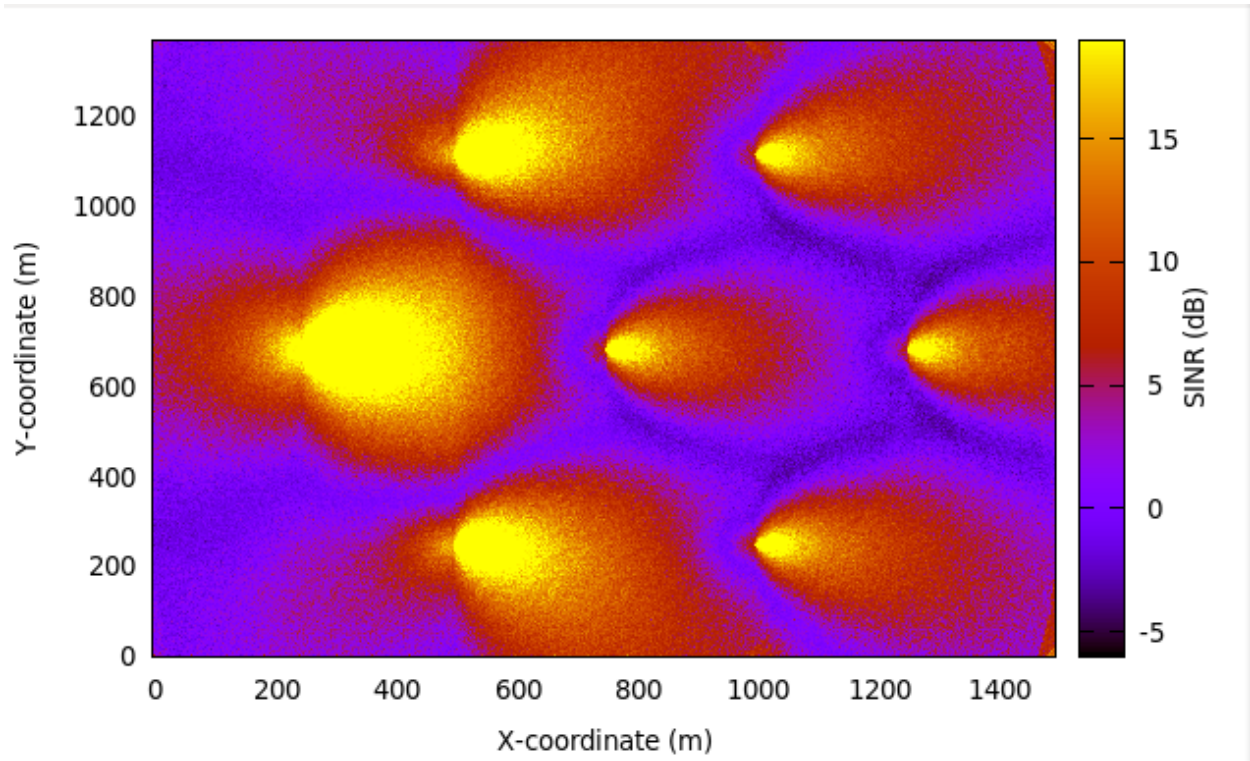

Fig. 78: REM for RB 1 obtained from `lena-dual-stripe` simulation with Hard FR algorithm enabled

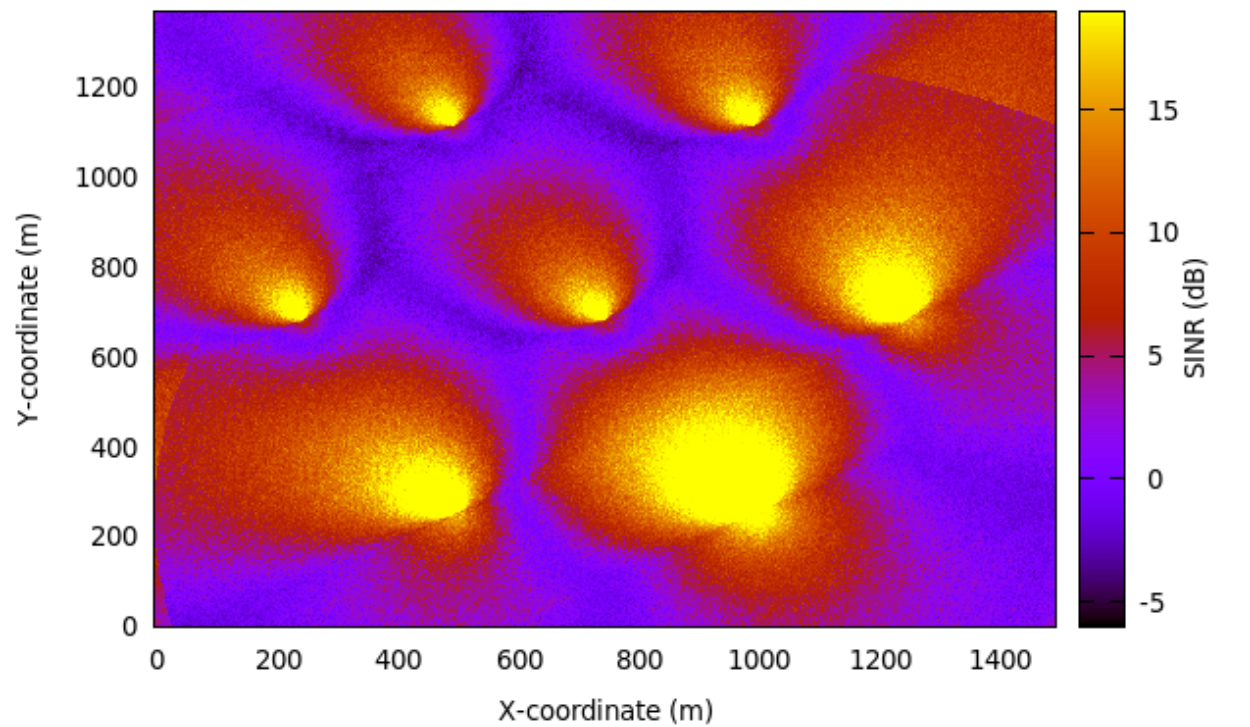

Fig. 79: REM for RB 10 obtained from `lena-dual-stripe` simulation with Hard FR algorithm enabled

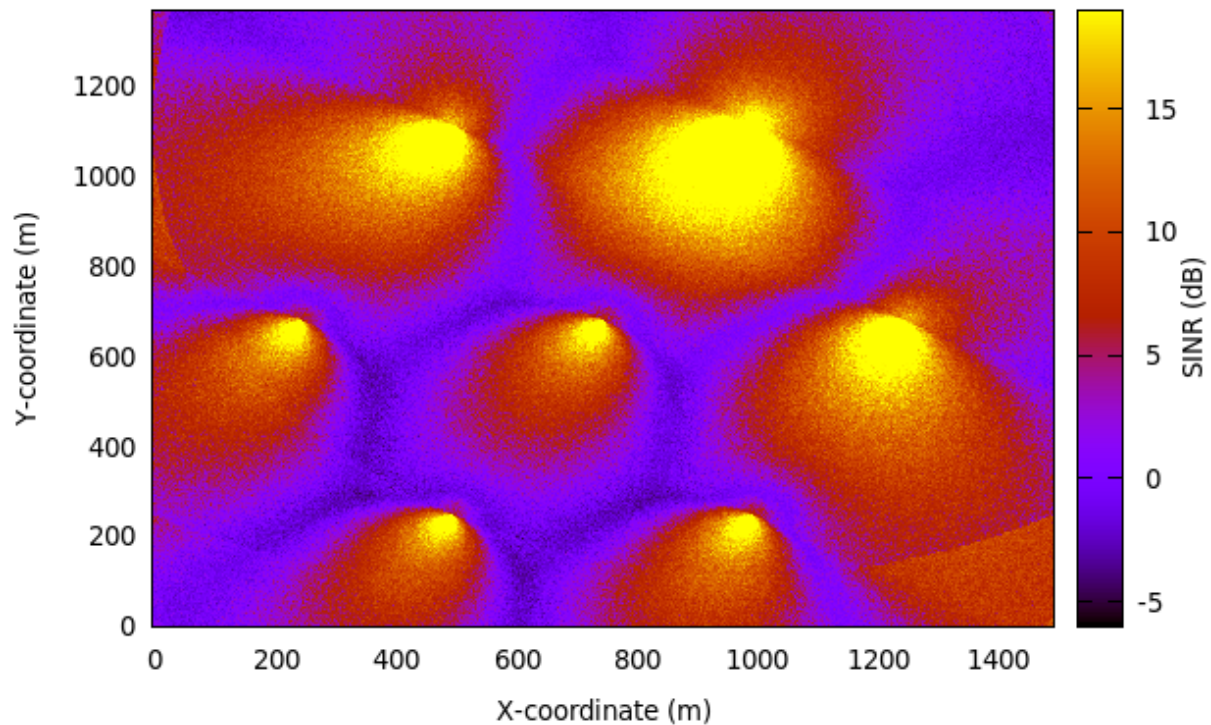

Fig. 80: REM for RB 20 obtained from `lena-dual-stripe` simulation with Hard FR algorithm enabled

```
./waf --run 'test-runner --suite=lte-carrier-aggregation'
```

To plot the test results, a file has to be created in the root folder of the ns-3 repository, and added to it with the following content :

```
set terminal png set xlabel "Number of users" set ylabel "Throughput per UE [Mbps]" set key top right
downlink_results="carrier_aggregation_results_dl.txt" uplink_results="carrier_aggregation_results_ul.txt"
set output "ca-test-example-dl.png" set title "Downlink performance"
```

```
plot downlink_results using 1:($2==1 ? $3/1000000 [1/0] w lp t 'NO SDL', \) downlink_results using
1:($2==2 ? $3/1000000 : 1/0) w lp t 'RR SDL 1', downlink_results using 1:($2==3 ? $3/1000000 :
1/0) w lp t 'RR SDL 2'
```

```
set output "ca-test-example-ul.png" set title "Uplink performance"
```

```
plot uplink_results using 1:($2==1 ? $3/1000000 [1/0] w lp t 'NO SDL', \) uplink_results using
1:($2==2 ? $3/1000000 : 1/0) w lp t 'RR SDL 1', uplink_results using 1:($2==3 ? $3/1000000
: 1/0) w lp t 'RR SDL 2'
```

`gnuplot` can be run by providing the file name, so that in the ns-3 root directory figures are generated. An example to run this test suite is shown in figures: *fig-ca-test-example-ul* and *fig-ca-test-example-dl*.

### 19.2.25 Radio link failure example

The example *lena-radio-link-failure.cc* is an example to simulate the RLF functionality. In particular, it simulates only one moving UE using *Ideal* or *Real* RRC protocol with EPC performing downlink and uplink communication in two scenarios shown in *Scenario A: Radio link failure example with one eNB* and *Scenario B: Radio link failure example with two eNBs*

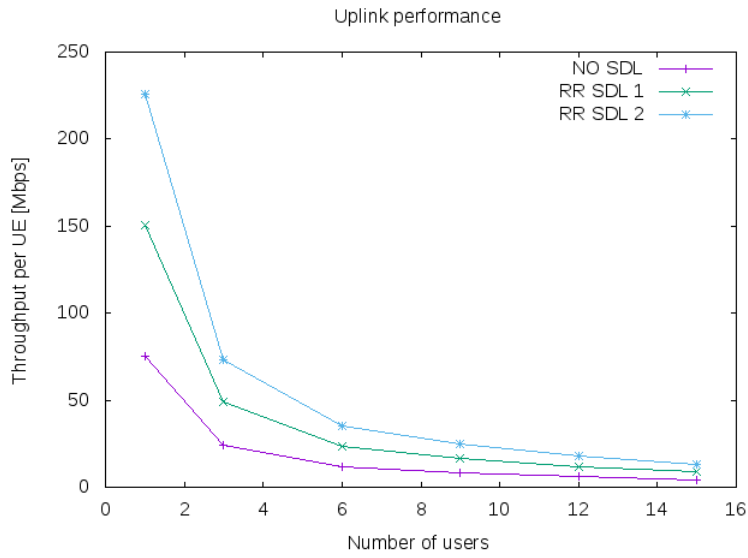

Fig. 81: Example of CA test performance in the uplink

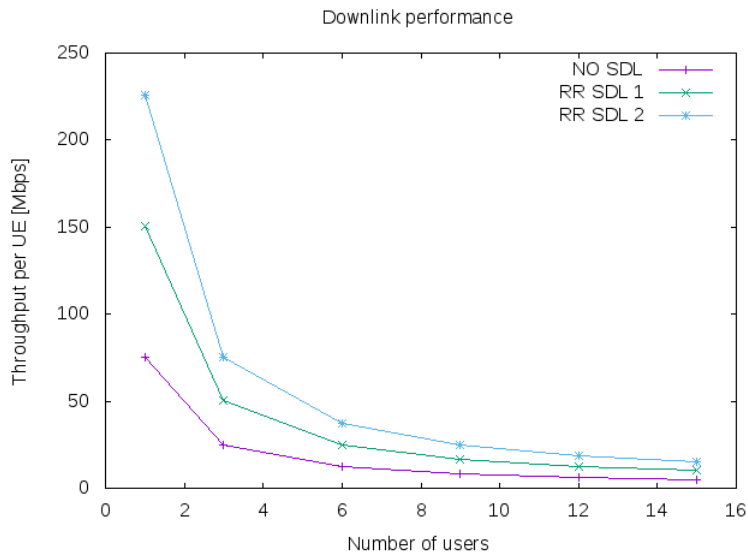

Fig. 82: Example of CA test performance in the downlink

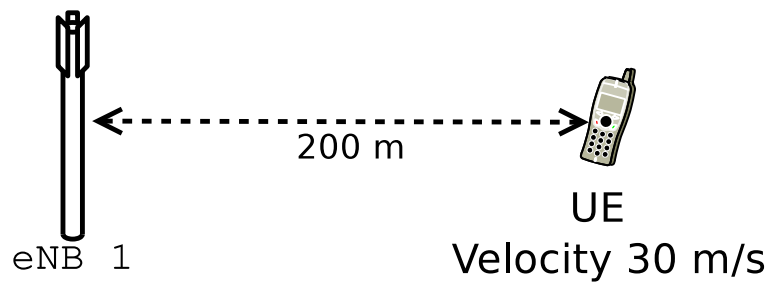

Fig. 83: Scenario A: Radio link failure example with one eNB



We note that, the RLF detection is enabled by default, which can be disabled by configuring the `LteUePhy::EnableRlfDetection` to false, e.g.,:

```
Config::SetDefault ("ns3::LteUePhy::EnableRlfDetection", BooleanValue (false));
```

In this example, to study the impact of a RLF on the user's quality of experience, we compute an instantaneous (i.e., every 200 ms) DL throughput of the UE, and writes it into a file for plotting purposes. For example, to simulate the "Scenario A" with *Ideal* and *Real* RRC protocol a user can use the following commands:

```
Ideal RRC:
./waf --run "lena-radio-link-failure
--numberOfEnbs=1 --useIdealRrc=1
--interSiteDistance=1200 --n310=1 --n311=1
--t310=1 --enableCtrlErrorModel=1
--enableDataErrorModel=1 --simTime=25"
```

```
Real RRC:
./waf --run "lena-radio-link-failure
--numberOfEnbs=1 --useIdealRrc=0
--interSiteDistance=1200 --n310=1 --n311=1
--t310=1 --enableCtrlErrorModel=1
--enableDataErrorModel=1 --simTime=25"
```

After running the above two commands, we can use a simple gnuplot script to plot the throughput as shown in the Figure *Downlink instantaneous throughput of UE in scenario A*, e.g.,

```
set terminal png
set output "lena-radio-link-failure-one-enb-thrput.png"
set multiplot
set xlabel "Time [s]"
set ylabel "Instantaneous throughput UE [Mbps]"
set grid
set title "LTE RLF example 1 eNB DL instantaneous throughput"
plot "rlf_dl_thrput_1_eNB_ideal_rrc" using ($1):($2) with linespoints
title 'Ideal RRC' linestyle 1 lw 2 lc rgb 'blue', "rlf_dl_thrput_1_eNB_real_rrc"
using ($1):($2) with linespoints title 'Real RRC' linestyle 2 lw 2 lc rgb 'red'

unset multiplot
```

In this scenario, when using the *Ideal* RRC the UE after the RLF will connect and disconnect from the eNB several times. This is because it can synchronize (i.e., start reading system information) with an eNB at a low RSRP level, which is default to -140 dBm (see `QRxLevMin` attribute of eNB RRC). It enables the UE to start the random access procedure with the eNB. With the *Ideal* RRC, the UE can complete the random access without any errors, since all the RRC messages are exchanged ideally between the eNB and the UE. However, soon after the connection establishment, it ends up in RLF due to the poor channel quality. On the other hand, with the *Real* RRC the UE after the RLF will not be able to complete the random access procedure due to the poor channel conditions, thus, will not be able to establish the connection with the eNB. Therefore, in both the cases the UE throughput drops to zero as shown in the Figure *Downlink instantaneous throughput of UE in scenario A*.

Similarly, to simulate the "Scenario B" with *Ideal* and *Real* RRC protocol following commands can be used:

```
Ideal RRC:
./waf --run "lena-radio-link-failure
--numberOfEnbs=2 --useIdealRrc=1
--interSiteDistance=1200 --n310=1 --n311=1
--t310=1 --enableCtrlErrorModel=1
--enableDataErrorModel=1 --simTime=25"
```

(continues on next page)

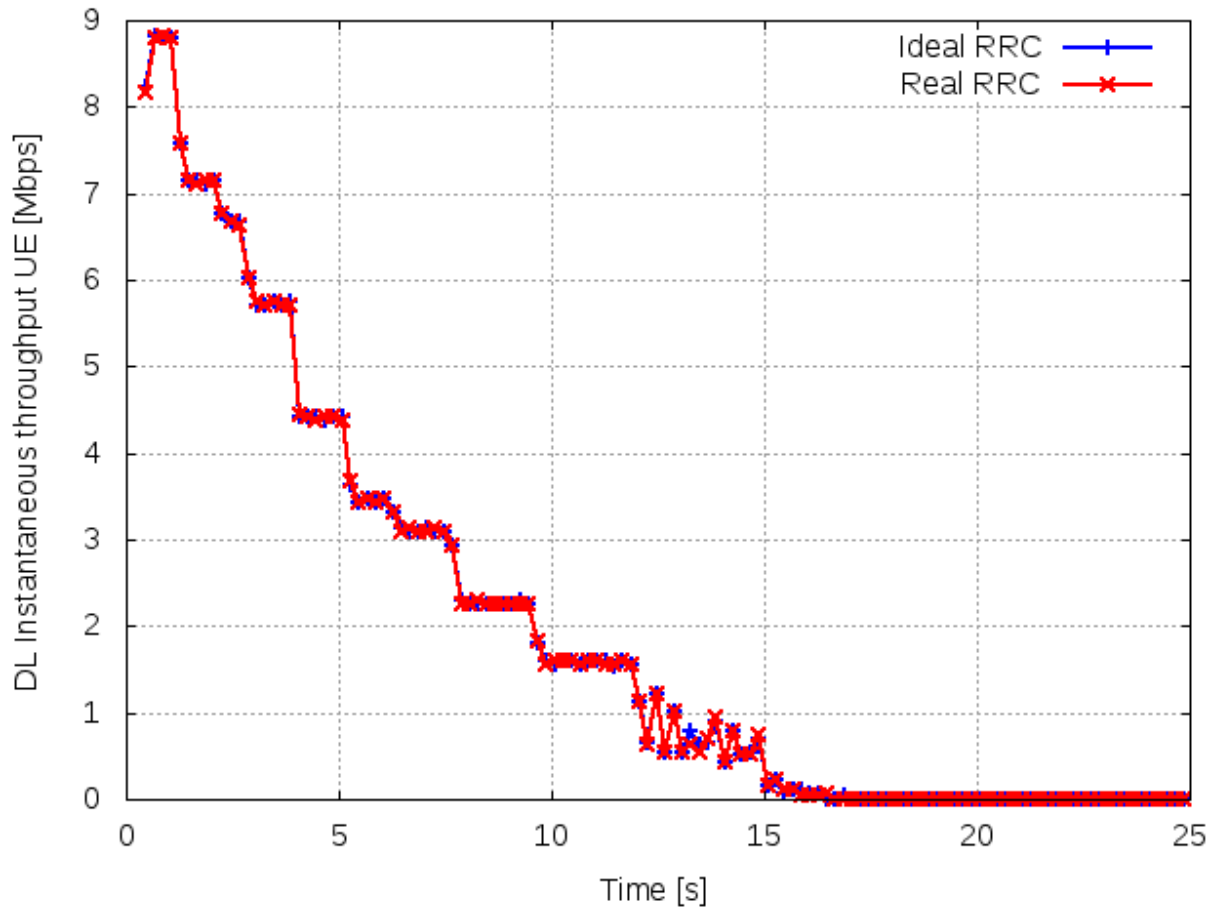

Fig. 84: Downlink instantaneous throughput of UE in scenario A

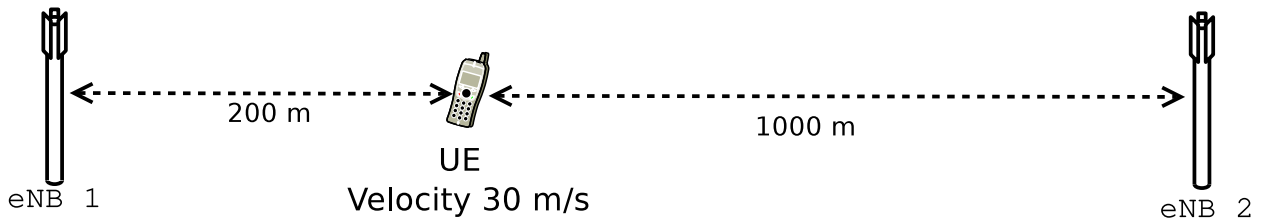

Fig. 85: Scenario B: Radio link failure example with two eNBs

(continued from previous page)

```

Real RRC:
./waf --run "lena-radio-link-failure
--numberOfEnbs=2 --useIdealRrc=0
--interSiteDistance=1200 --n310=1 --n311=1
--t310=1 --enableCtrlErrorModel=1
--enableDataErrorModel=1 --simTime=25"

```

Figure *Downlink instantaneous throughput of UE in scenario B*, shows the throughput in “Scenario B”. We note that in this scenario the handover algorithm is not used. As expected, with *Ideal RRC* protocol the UE after the RLF can complete the random access procedure with the second eNB. Interestingly, the DL SINR after the connection establishment is not low enough to trigger the RLF, but it is low enough to impact the DL control reception for some TBs, which in turn causes loss of data. It can be observed from the slightly unstable throughput of the UE after connecting to the second eNB. On the other hand, with *Real RRC* the UE faces problems in connection establishment phase due to the loss of RRC messages, in particular, the RRC connection request from the UE. This is the reason why the UE throughput after the RLF remains zero for a more extended period as compared to the *ideal RRC* protocol.

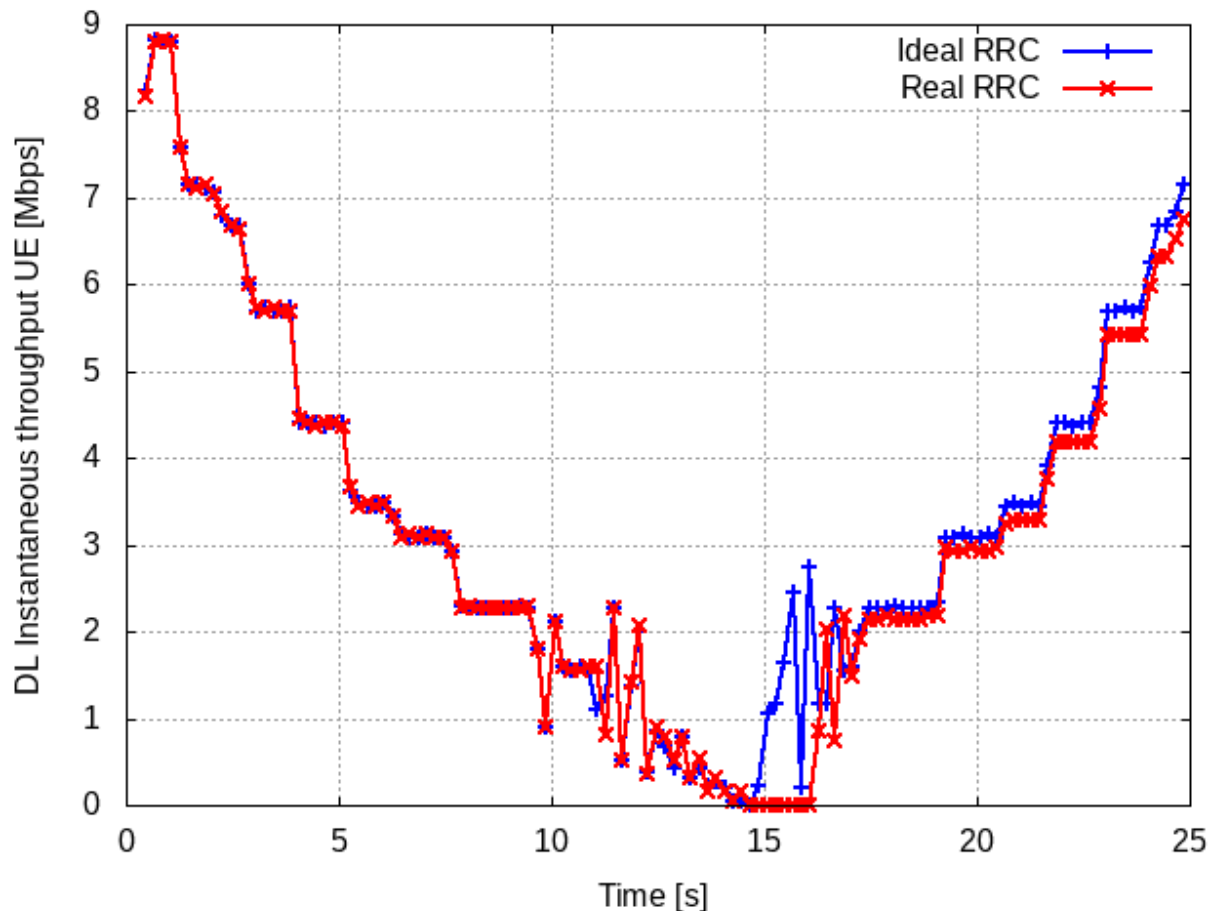

Fig. 86: Downlink instantaneous throughput of UE in scenario B

## 19.2.26 Troubleshooting and debugging tips

Many users post on the ns-3-users mailing list asking, for example, why they do not get any traffic in their simulation, or maybe only uplink but no downlink traffic is generated, etc. In most of the cases, this is a bug in the user simulation program. Here the reader can find some tips to debug the program and find out the cause of the problem.

The general approach is to selectively and incrementally enable the logging of relevant LTE module components, verifying upon each activation that the output is as expected. In detail:

- first check the control plane, in particular the RRC connection establishment procedure, by enabling the log components `LteUeRrc` and `LteEnbRrc`
- then check packet transmissions on the data plane, starting by enabling the log components `LteUeNetDevice` and the `EpcSgwApplication`, `EpcPgwApplication` and `EpcEnbApplication`, then moving down the LTE radio stack (PDCP, RLC, MAC, and finally PHY). All this until you find where packets stop being processed / forwarded.

## 19.3 Testing Documentation

### 19.3.1 Overview

To test and validate the ns-3 LTE module, several test suites are provided which are integrated with the ns-3 test framework. To run them, you need to have configured the build of the simulator in this way:

```
$ ./waf configure --enable-tests --enable-modules=lte --enable-examples
$ ./test.py
```

The above will run not only the test suites belonging to the LTE module, but also those belonging to all the other ns-3 modules on which the LTE module depends. See the ns-3 manual for generic information on the testing framework.

You can get a more detailed report in HTML format in this way:

```
$ ./test.py -w results.html
```

After the above command has run, you can view the detailed result for each test by opening the file `results.html` with a web browser.

You can run each test suite separately using this command:

```
$ ./test.py -s test-suite-name
```

For more details about `test.py` and the ns-3 testing framework, please refer to the ns-3 manual.

### 19.3.2 Description of the test suites

#### Unit Tests

#### SINR calculation in the Downlink

The test suite `lte-downlink-sinr` checks that the SINR calculation in downlink is performed correctly. The SINR in the downlink is calculated for each RB assigned to data transmissions by dividing the power of the intended signal from the considered eNB by the sum of the noise power plus all the transmissions on the same RB coming from other eNBs (the interference signals):

$$\gamma = \frac{P_{\text{signal}}}{P_{\text{noise}} + \sum P_{\text{interference}}}$$

In general, different signals can be active during different periods of time. We define a *chunk* as the time interval between any two events of type either start or end of a waveform. In other words, a chunk identifies a time interval during which the set of active waveforms does not change. Let  $i$  be the generic chunk,  $T_i$  its duration and  $\text{SINR}_i$  its SINR, calculated with the above equation. The calculation of the average SINR  $\bar{\gamma}$  to be used for CQI feedback reporting uses the following formula:

$$\bar{\gamma} = \frac{\sum_i \gamma_i T_i}{\sum_i T_i}$$

The test suite checks that the above calculation is performed correctly in the simulator. The test vectors are obtained offline by an Octave script that implements the above equation, and that recreates a number of random transmitted signals and interference signals that mimic a scenario where an UE is trying to decode a signal from an eNB while facing interference from other eNBs. The test passes if the calculated values are equal to the test vector within a tolerance of  $10^{-7}$ . The tolerance is meant to account for the approximation errors typical of floating point arithmetic.

### SINR calculation in the Uplink

The test suite `lte-uplink-sinr` checks that the SINR calculation in uplink is performed correctly. This test suite is identical to `lte-downlink-sinr` described in the previous section, with the difference that both the signal and the interference now refer to transmissions by the UEs, and reception is performed by the eNB. This test suite recreates a number of random transmitted signals and interference signals to mimic a scenario where an eNB is trying to decode the signal from several UEs simultaneously (the ones in the cell of the eNB) while facing interference from other UEs (the ones belonging to other cells).

The test vectors are obtained by a dedicated Octave script. The test passes if the calculated values are equal to the test vector within a tolerance of  $10^{-7}$  which, as for the downlink SINR test, deals with floating point arithmetic approximation issues.

### E-UTRA Absolute Radio Frequency Channel Number (EARFCN)

The test suite `lte-earfcn` checks that the carrier frequency used by the `LteSpectrumValueHelper` class (which implements the LTE spectrum model) is done in compliance with [TS36101], where the E-UTRA Absolute Radio Frequency Channel Number (EARFCN) is defined. The test vector for this test suite comprises a set of EARFCN values and the corresponding carrier frequency calculated by hand following the specification of [TS36101]. The test passes if the carrier frequency returned by `LteSpectrumValueHelper` is the same as the known value for each element in the test vector.

## System Tests

### Dedicated Bearer Deactivation Tests

The test suite ‘`lte-test-deactivate-bearer`’ creates test case with single ENodeB and Three UE’s. Each UE consists of one Default and one Dedicated EPS bearer with same bearer specification but with different ARP. Test Case Flow is as follows: Attach UE -> Create Default+Dedicated Bearer -> Deactivate one of the Dedicated bearer

Test case further deactivates dedicated bearer having bearer ID 2(LCID=BearerId+2) of First UE (UE\_ID=1) User can schedule bearer deactivation after specific time delay using `Simulator::Schedule ()` method.

Once the test case execution ends it will create `DlRlcStats.txt` and `UlRlcStats.txt`. Key fields that need to be checked in statistics are:

```
|Start | end | Cell ID | IMSI | RNTI | LCID | TxBytes | RxBytes |
```

Test case executes in three epochs:

1. In first Epoch (0.04s-1.04s) All UE's and corresponding bearers gets attached and packet flow over the dedicated bearers activated.
2. In second Epoch (1.04s-2.04s), bearer deactivation is instantiated, hence User can see relatively less number of TxBytes on UE\_ID=1 and LCID=4 as compared to other bearers.
3. In third Epoch (2.04s-3.04s) since bearer deactivation of UE\_ID=1 and LCID=4 is completed, user will not see any logging related to LCID=4.

Test case passes if and only if

1. IMSI=1 and LCID=4 completely removed in third epoch
2. No packets seen in TxBytes and RxBytes corresponding to IMSI=1 and LCID=4

If above criteria do not match, the test case is considered to be failed

### Adaptive Modulation and Coding Tests

The test suite `lte-link-adaptation` provides system tests recreating a scenario with a single eNB and a single UE. Different test cases are created corresponding to different SNR values perceived by the UE. The aim of the test is to check that in each test case the chosen MCS corresponds to some known reference values. These reference values are obtained by re-implementing in Octave (see `src/lte/test/reference/lte_amc.m`) the model described in Section *Adaptive Modulation and Coding* for the calculation of the spectral efficiency, and determining the corresponding MCS index by manually looking up the tables in [R1-081483]. The resulting test vector is represented in Figure *Test vector for Adaptive Modulation and Coding*.

The MCS which is used by the simulator is measured by obtaining the tracing output produced by the scheduler after 4ms (this is needed to account for the initial delay in CQI reporting). The SINR which is calculated by the simulator is also obtained using the `LteChunkProcessor` interface. The test passes if both the following conditions are satisfied:

1. the SINR calculated by the simulator correspond to the SNR of the test vector within an absolute tolerance of  $10^{-7}$ ;
2. the MCS index used by the simulator exactly corresponds to the one in the test vector.

### Inter-cell Interference Tests

The test suite `lte-interference` provides system tests recreating an inter-cell interference scenario with two eNBs, each having a single UE attached to it and employing Adaptive Modulation and Coding both in the downlink and in the uplink. The topology of the scenario is depicted in Figure *Topology for the inter-cell interference test*. The  $d_1$  parameter represents the distance of each UE to the eNB it is attached to, whereas the  $d_2$  parameter represent the interferer distance. We note that the scenario topology is such that the interferer distance is the same for uplink and downlink; still, the actual interference power perceived will be different, because of the different propagation loss in the uplink and downlink bands. Different test cases are obtained by varying the  $d_1$  and  $d_2$  parameters.

The test vectors are obtained by use of a dedicated octave script (available in `src/lte/test/reference/lte_link_budget_interference.m`), which does the link budget calculations (including interference) corresponding to the topology of each test case, and outputs the resulting SINR and spectral efficiency. The latter is then used to determine (using the same procedure adopted for *Adaptive Modulation and Coding Tests*). We note that the test vector contains separate values for uplink and downlink.

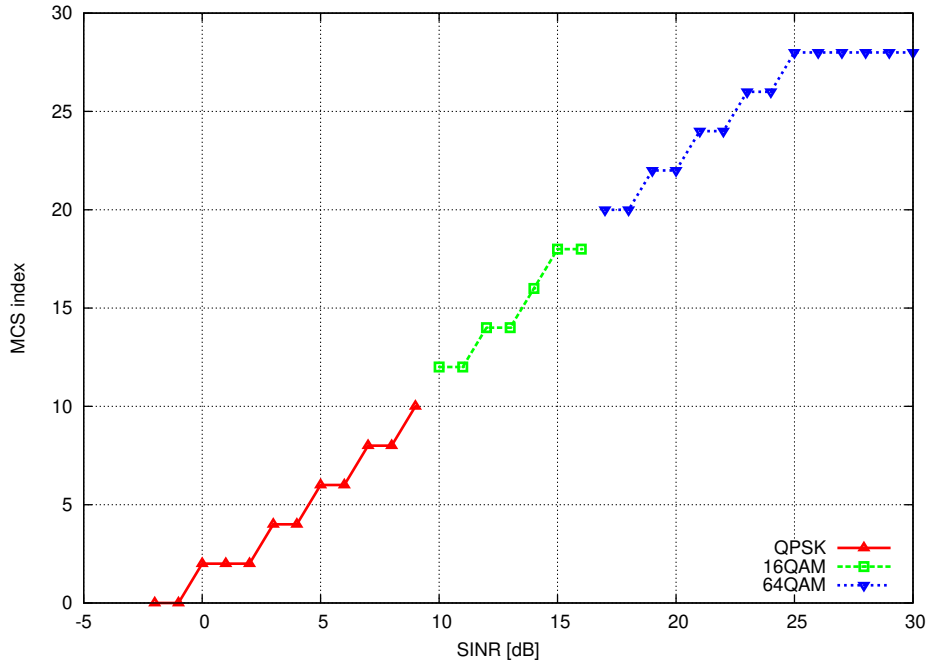

Fig. 87: Test vector for Adaptive Modulation and Coding

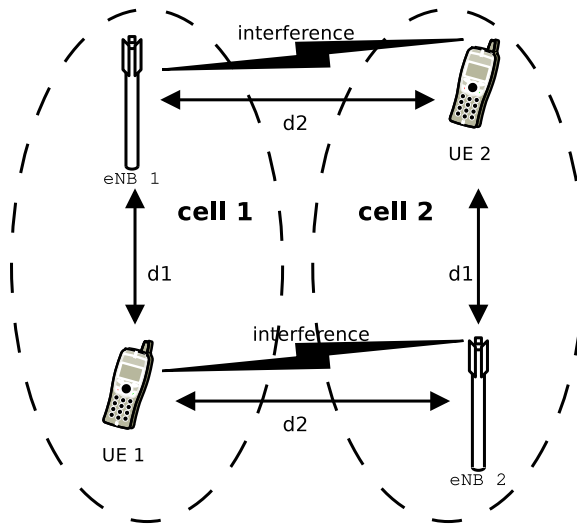

Fig. 88: Topology for the inter-cell interference test

## UE Measurements Tests

The test suite *lte-ue-measurements* provides system tests recreating an inter-cell interference scenario identical of the one defined for *lte-interference* test-suite. However, in this test the quantities to be tested are represented by RSRP and RSRQ measurements performed by the UE in two different points of the stack: the source, which is UE PHY layer, and the destination, that is the eNB RRC.

The test vectors are obtained by the use of a dedicated octave script (available in *src/lte/test/reference/lte-ue-measurements.m*), which does the link budget calculations (including interference) corresponding to the topology of each test case, and outputs the resulting RSRP and RSRQ. The obtained values are then used for checking the correctness of the UE Measurements at PHY layer. After that, they have to be converted according to 3GPP formatting for the purpose of checking their correctness at eNB RRC level.

## UE measurement configuration tests

Besides the previously mentioned test suite, there are 3 other test suites for testing UE measurements: *lte-ue-measurements-piecewise-1*, *lte-ue-measurements-piecewise-2*, and *lte-ue-measurements-handover*. These test suites are more focused on the reporting trigger procedure, i.e. the correctness of the implementation of the event-based triggering criteria is verified here.

In more specific, the tests verify the *timing* and the *content* of each measurement reports received by eNodeB. Each test case is an stand-alone LTE simulation and the test case will pass if measurement report(s) only occurs at the prescribed time and shows the correct level of RSRP (RSRQ is not verified at the moment).

## Piecewise configuration

The piecewise configuration aims to test a particular UE measurements configuration. The simulation script will setup the corresponding measurements configuration to the UE, which will be active throughout the simulation.

Since the reference values are precalculated by hands, several assumptions are made to simplify the simulation. Firstly, the channel is only affected by path loss model (in this case, Friis model is used). Secondly, the ideal RRC protocol is used, and layer 3 filtering is disabled. Finally, the UE moves in a predefined motion pattern between 4 distinct spots, as depicted in Figure *UE movement trace throughout the simulation in piecewise configuration* below. Therefore the fluctuation of the measured RSRP can be determined more easily.

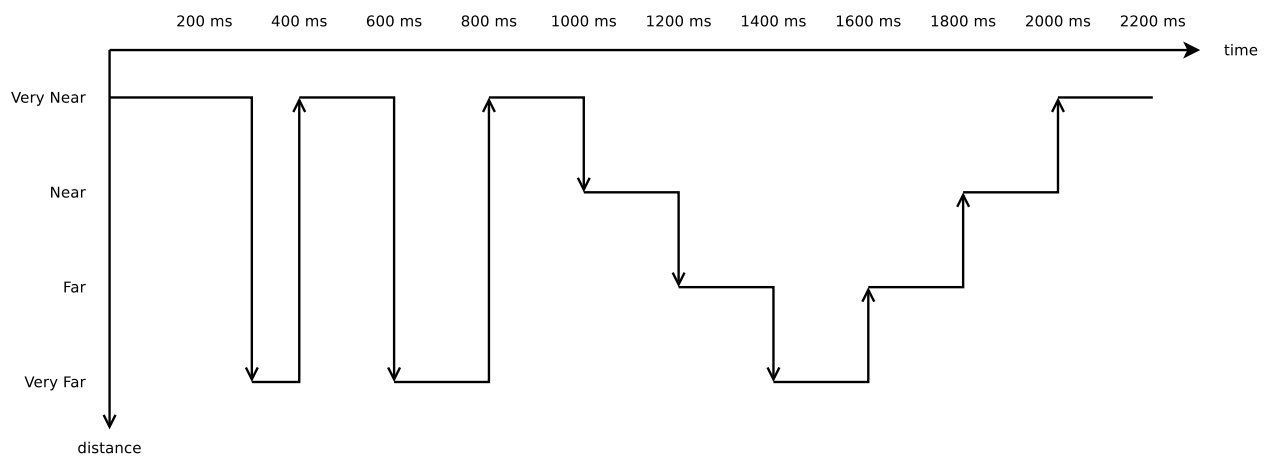

Fig. 89: UE movement trace throughout the simulation in piecewise configuration



The motivation behind the “teleport” between the predefined spots is to introduce drastic change of RSRP level, which will guarantee the triggering of entering or leaving condition of the tested event. By performing drastic changes, the test can be run within shorter amount of time.

Figure *Measured RSRP trace of an example Event A1 test case in piecewise configuration* below shows the measured RSRP after layer 1 filtering by the PHY layer during the simulation with a piecewise configuration. Because layer 3 filtering is disabled, these are the exact values used by the UE RRC instance to evaluate reporting trigger procedure. Notice that the values are refreshed every 200 ms, which is the default filtering period of PHY layer measurements report. The figure also shows the time when entering and leaving conditions of an example instance of Event A1 (serving cell becomes better than threshold) occur during the simulation.

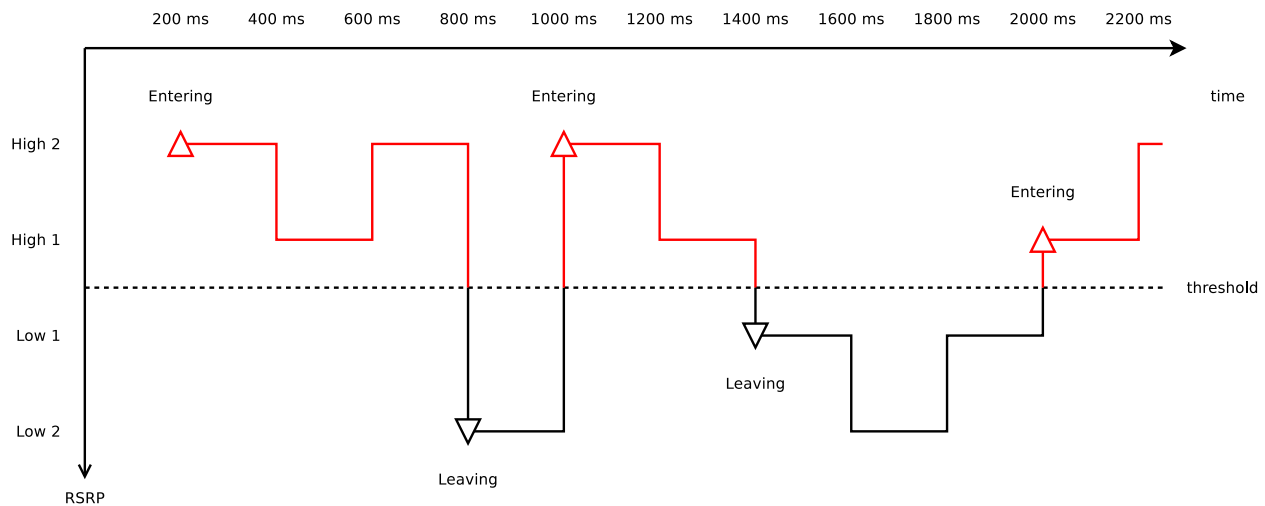

Fig. 90: Measured RSRP trace of an example Event A1 test case in piecewise configuration

Each reporting criterion is tested several times with different threshold/offset parameters. Some test scenarios also take hysteresis and time-to-trigger into account. Figure *Measured RSRP trace of an example Event A1 with hysteresis test case in piecewise configuration* depicts the effect of hysteresis in another example of Event A1 test.

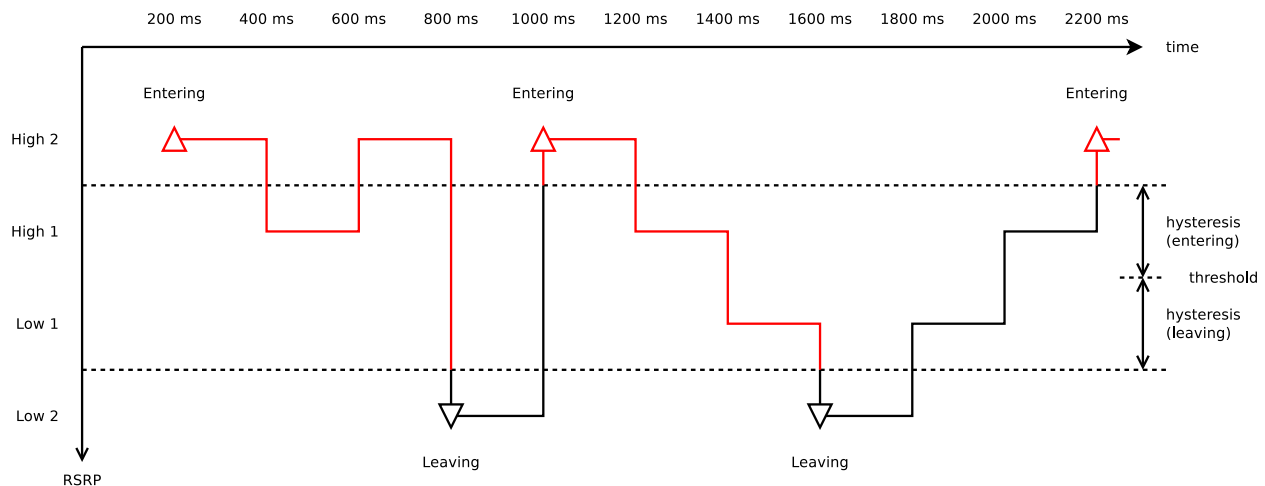

Fig. 91: Measured RSRP trace of an example Event A1 with hysteresis test case in piecewise configuration

Piecewise configuration is used in two test suites of UE measurements. The first one is *lte-ue-measurements-piecewise-1*, henceforth Piecewise test #1, which simulates 1 UE and 1 eNodeB. The other one is *lte-ue-measurements-piecewise-2*, which has 1 UE and 2 eNodeBs in the simulation.

Piecewise test #1 is intended to test the event-based criteria which are not dependent on the existence of a neighboring cell. These criteria include Event A1 and A2. The other events are also briefly tested to verify that they are still working correctly (albeit not reporting anything) in the absence of any neighboring cell. Table *UE measurements test scenarios using piecewise configuration #1* below lists the scenarios tested in piecewise test #1.

Table 7: UE measurements test scenarios using piecewise configuration #1

Test #	Reporting Criteria	Threshold/Offset	Hysteresis	Time-to-Trigger
1	Event A1	Low	No	No
2	Event A1	Normal	No	No
3	Event A1	Normal	No	Short
4	Event A1	Normal	No	Long
5	Event A1	Normal	No	Super
6	Event A1	Normal	Yes	No
7	Event A1	High	No	No
8	Event A2	Low	No	No
9	Event A2	Normal	No	No
10	Event A2	Normal	No	Short
11	Event A2	Normal	No	Long
12	Event A2	Normal	No	Super
13	Event A2	Normal	Yes	No
14	Event A2	High	No	No
15	Event A3	Zero	No	No
16	Event A4	Normal	No	No
17	Event A5	Normal-Normal	No	No

Other events such as Event A3, A4, and A5 depend on measurements of neighbouring cell, so they are more thoroughly tested in Piecewise test #2. The simulation places the nodes on a straight line and instruct the UE to “*jump*” in a similar manner as in Piecewise test #1. Handover is disabled in the simulation, so the role of serving and neighbouring cells do not switch during the simulation. Table *UE measurements test scenarios using piecewise configuration #2* below lists the scenarios tested in Piecewise test #2.

Table 8: UE measurements test scenarios using piecewise configuration #2

Test #	Reporting Criteria	Threshold/Offset	Hysteresis	Time-to-Trigger
1	Event A1	Low	No	No
2	Event A1	Normal	No	No
3	Event A1	Normal	Yes	No
4	Event A1	High	No	No
5	Event A2	Low	No	No
6	Event A2	Normal	No	No
7	Event A2	Normal	Yes	No
8	Event A2	High	No	No
9	Event A3	Positive	No	No
10	Event A3	Zero	No	No
11	Event A3	Zero	No	Short
12	Event A3	Zero	No	Super
13	Event A3	Zero	Yes	No
14	Event A3	Negative	No	No
15	Event A4	Low	No	No
16	Event A4	Normal	No	No

Continued on next page

Table 8 – continued from previous page

Test #	Reporting Criteria	Threshold/Offset	Hysteresis	Time-to-Trigger
17	Event A4	Normal	No	Short
18	Event A4	Normal	No	Super
19	Event A4	Normal	Yes	No
20	Event A4	High	No	No
21	Event A5	Low-Low	No	No
22	Event A5	Low-Normal	No	No
23	Event A5	Low-High	No	No
24	Event A5	Normal-Low	No	No
25	Event A5	Normal-Normal	No	No
26	Event A5	Normal-Normal	No	Short
27	Event A5	Normal-Normal	No	Super
28	Event A5	Normal-Normal	Yes	No
29	Event A5	Normal-High	No	No
30	Event A5	High-Low	No	No
31	Event A5	High-Normal	No	No
32	Event A5	High-High	No	No

One note about the tests with time-to-trigger, they are tested using 3 different values of time-to-trigger: *short* (shorter than report interval), *long* (shorter than the filter measurement period of 200 ms), and *super* (longer than 200 ms). The first two ensure that time-to-trigger evaluation always use the latest measurement reports received from PHY layer. While the last one is responsible for verifying time-to-trigger cancellation, for example when a measurement report from PHY shows that the entering/leaving condition is no longer true before the first trigger is fired.

### Handover configuration

The purpose of the handover configuration is to verify whether UE measurement configuration is updated properly after a successful handover takes place. For this purpose, the simulation will construct 2 eNodeBs with different UE measurement configuration, and the UE will perform handover from one cell to another. The UE will be located on a straight line between the 2 eNodeBs, and the handover will be invoked manually. The duration of each simulation is 2 seconds (except the last test case) and the handover is triggered exactly at halfway of simulation.

The *lte-ue-measurements-handover* test suite covers various types of configuration differences. The first one is the difference in report interval, e.g. the first eNodeB is configured with 480 ms report interval, while the second eNodeB is configured with 240 ms report interval. Therefore, when the UE performed handover to the second cell, the new report interval must take effect. As in piecewise configuration, the timing and the content of each measurement report received by the eNodeB will be verified.

Other types of differences covered by the test suite are differences in event and differences in threshold/offset. Table *UE measurements test scenarios using handover configuration* below lists the tested scenarios.

Table 9: UE measurements test scenarios using handover configuration

Test #	Test Subject	Initial Configuration	Post-Handover Configuration
1	Report interval	480 ms	240 ms
2	Report interval	120 ms	640 ms
3	Event	Event A1	Event A2
4	Event	Event A2	Event A1
5	Event	Event A3	Event A4
6	Event	Event A4	Event A3
7	Event	Event A2	Event A3
8	Event	Event A3	Event A2
9	Event	Event A4	Event A5
10	Event	Event A5	Event A4
11	Threshold/offset	RSRP range 52 (Event A1)	RSRP range 56 (Event A1)
12	Threshold/offset	RSRP range 52 (Event A2)	RSRP range 56 (Event A2)
13	Threshold/offset	A3 offset -30 (Event A3)	A3 offset +30 (Event A3)
14	Threshold/offset	RSRP range 52 (Event A4)	RSRP range 56 (Event A4)
15	Threshold/offset	RSRP range 52-52 (Event A5)	RSRP range 56-56 (Event A5)
16	Time-to-trigger	1024 ms	100 ms
17	Time-to-trigger	1024 ms	640 ms

### Round Robin scheduler performance

The test suite `lte-rr-ff-mac-scheduler` creates different test cases with a single eNB and several UEs, all having the same Radio Bearer specification. In each test case, the UEs see the same SINR from the eNB; different test cases are implemented by using different distance among UEs and the eNB (i.e., therefore having different SINR values) and different numbers of UEs. The test consists on checking that the obtained throughput performance is equal among users and matches a reference throughput value obtained according to the SINR perceived within a given tolerance.

The test vector is obtained according to the values of transport block size reported in table 7.1.7.2.1-1 of [TS36213], considering an equal distribution of the physical resource block among the users using Resource Allocation Type 0 as defined in Section 7.1.6.1 of [TS36213]. Let  $\tau$  be the TTI duration,  $N$  be the number of UEs,  $B$  the transmission bandwidth configuration in number of RBs,  $G$  the RBG size,  $M$  the modulation and coding scheme in use at the given SINR and  $S(M, B)$  be the transport block size in bits as defined by 3GPP TS 36.213. We first calculate the number  $L$  of RBGs allocated to each user as

$$L = \left\lfloor \frac{B}{NG} \right\rfloor$$

The reference throughput  $T$  in bit/s achieved by each UE is then calculated as

$$T = \frac{S(M, LG)}{8 \tau}$$

The test passes if the measured throughput matches with the reference throughput within a relative tolerance of 0.1. This tolerance is needed to account for the transient behavior at the beginning of the simulation (e.g., CQI feedback is only available after a few subframes) as well as for the accuracy of the estimator of the average throughput performance over the chosen simulation time (0.4s). This choice of the simulation time is justified by the need to follow the ns-3 guidelines of keeping the total execution time of the test suite low, in spite of the high number of test cases. In any case, we note that a lower value of the tolerance can be used when longer simulations are run.

In Figure [fig-lenaThrTestCase1](#), the curves labeled “RR” represent the test values calculated for the RR scheduler test, as a function of the number of UEs and of the MCS index being used in each test case.

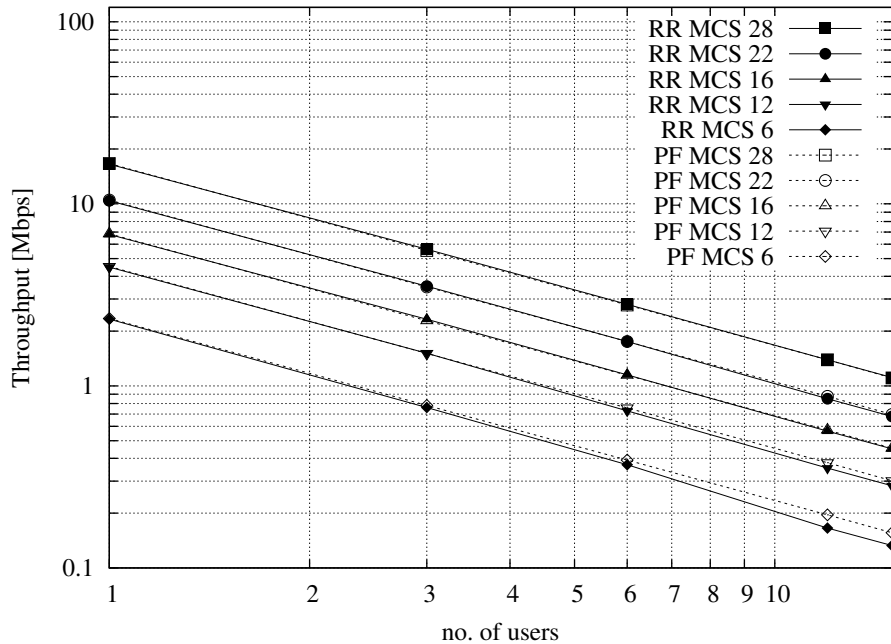

Fig. 92: Test vectors for the RR and PF Scheduler in the downlink in a scenario where all UEs use the same MCS.

### Proportional Fair scheduler performance

The test suite `lte-pf-ff-mac-scheduler` creates different test cases with a single eNB, using the Proportional Fair (PF) scheduler, and several UEs, all having the same Radio Bearer specification. The test cases are grouped in two categories in order to evaluate the performance both in terms of the adaptation to the channel condition and from a fairness perspective.

In the first category of test cases, the UEs are all placed at the same distance from the eNB, and hence all placed in order to have the same SINR. Different test cases are implemented by using a different SINR value and a different number of UEs. The test consists on checking that the obtained throughput performance matches with the known reference throughput up to a given tolerance. The expected behavior of the PF scheduler when all UEs have the same SNR is that each UE should get an equal fraction of the throughput obtainable by a single UE when using all the resources. We calculate the reference throughput value by dividing the throughput achievable by a single UE at the given SNR by the total number of UEs. Let  $\tau$  be the TTI duration,  $B$  the transmission bandwidth configuration in number of RBs,  $M$  the modulation and coding scheme in use at the given SINR and  $S(M, B)$  be the transport block size as defined in [TS36213]. The reference throughput  $T$  in bit/s achieved by each UE is calculated as

$$T = \frac{S(M, B)}{\tau N}$$

The curves labeled “PF” in Figure [fig-lenaThrTestCase1](#) represent the test values calculated for the PF scheduler tests of the first category, that we just described.

The second category of tests aims at verifying the fairness of the PF scheduler in a more realistic simulation scenario where the UEs have a different SINR (constant for the whole simulation). In these conditions, the PF scheduler will give to each user a share of the system bandwidth that is proportional to the capacity achievable by a single user alone considered its SINR. In detail, let  $M_i$  be the modulation and coding scheme being used by each UE (which is a deterministic function of the SINR of the UE, and is hence known in this scenario). Based on the MCS, we determine the achievable rate  $R_i$  for each user  $i$  using the procedure described in Section-[ref{sec:pf}](#). We then define the

achievable rate ratio  $\rho_{R,i}$  of each user  $i$  as

$$\rho_{R,i} = \frac{R_i}{\sum_{j=1}^N R_j}$$

Let now  $T_i$  be the throughput actually achieved by the UE  $i$ , which is obtained as part of the simulation output. We define the obtained throughput ratio  $\rho_{T,i}$  of UE  $i$  as

$$\rho_{T,i} = \frac{T_i}{\sum_{j=1}^N T_j}$$

The test consists of checking that the following condition is verified:

$$\rho_{R,i} = \rho_{T,i}$$

if so, it means that the throughput obtained by each UE over the whole simulation matches with the steady-state throughput expected by the PF scheduler according to the theory. This test can be derived from [Holtzman2000] as follows. From Section 3 of [Holtzman2000], we know that

$$\frac{T_i}{R_i} = c, \forall i$$

where  $c$  is a constant. By substituting the above into the definition of  $\rho_{T,i}$  given previously, we get

$$\begin{aligned} \frac{T_i}{\sum_{j=1}^N T_j} &= \frac{cR_i}{\sum_{j=1}^N cR_j} \\ &= \frac{cR_i}{c \sum_{j=1}^N R_j} \\ &= \frac{R_i}{\sum_{j=1}^N R_j} \end{aligned}$$

which is exactly the expression being used in the test.

Figure *Throughput ratio evaluation for the PF scheduler in a scenario where the UEs have MCS index 28, 24, 16, 12, 6* presents the results obtained in a test case with UEs  $i = 1, \dots, 5$  that are located at a distance from the base station such that they will use respectively the MCS index 28, 24, 16, 12, 6. From the figure, we note that, as expected, the obtained throughput is proportional to the achievable rate. In other words, the PF scheduler assign more resources to the users that use a higher MCS index.

## Maximum Throughput scheduler performance

Test suites `lte-fdmt-ff-mac-scheduler` and `lte-tdmt-ff-mac-scheduler` create different test cases with a single eNB and several UEs, all having the same Radio Bearer specification, using the Frequency Domain Maximum Throughput (FDMT) scheduler and Time Domain Maximum Throughput (TDMT) scheduler respectively. In other words, UEs are all placed at the same distance from the eNB, and hence all placed in order to have the same SNR. Different test cases are implemented by using a different SNR values and a different number of UEs. The test consists on checking that the obtained throughput performance matches with the known reference throughput up to a given tolerance. The expected behavior of both FDMT and TDMT scheduler when all UEs have the same SNR is that scheduler allocates all RBGs to the first UE defined in script. This is because the current FDMT and TDMT implementation always select the first UE to serve when there are multiple UEs having the same SNR value. We calculate the reference throughput value for first UE by the throughput achievable of a single UE at the given SNR, while reference throughput value for other UEs by zero. Let  $\tau$  be the TTI duration,  $B$  the transmission bandwidth configuration in number of RBs,  $M$  the modulation and coding scheme in use at the given SNR and  $S(M, B)$  be the transport block size as defined in [TS36213]. The reference throughput  $T$  in bit/s achieved by each UE is calculated as

$$T = \frac{S(M, B)}{\tau}$$

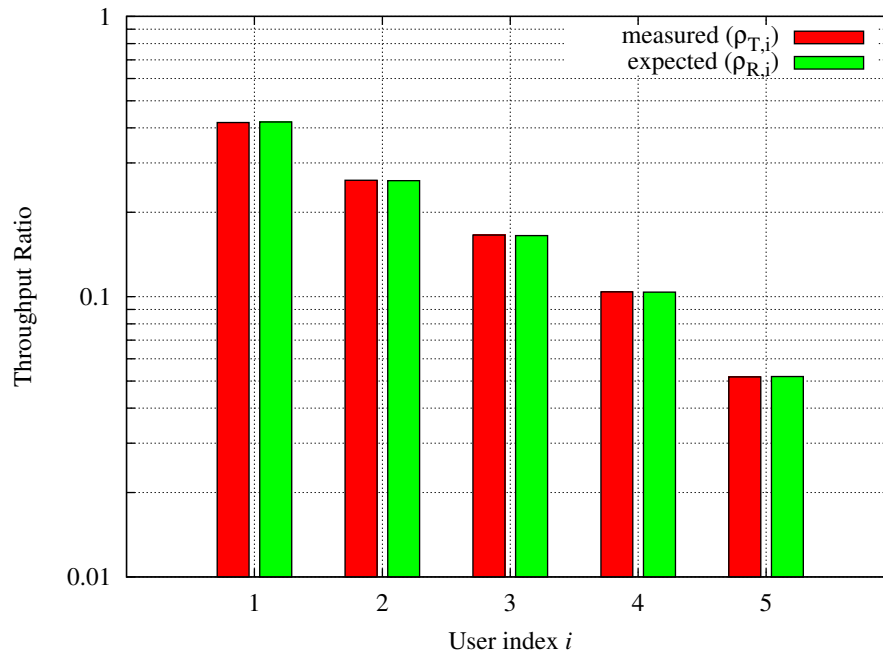

Fig. 93: Throughput ratio evaluation for the PF scheduler in a scenario where the UEs have MCS index 28, 24, 16, 12, 6

### Throughput to Average scheduler performance

Test suites `lte-tta-ff-mac-scheduler` create different test cases with a single eNB and several UEs, all having the same Radio Bearer specification using TTA scheduler. Network topology and configurations in TTA test case are as the same as the test for MT scheduler. More complex test case needs to be developed to show the fairness feature of TTA scheduler.

### Blind Average Throughput scheduler performance

Test suites `lte-tdbet-ff-mac-scheduler` and `lte-fdbet-ff-mac-scheduler` create different test cases with a single eNB and several UEs, all having the same Radio Bearer specification.

In the first test case of `lte-tdbet-ff-mac-scheduler` and `lte-fdbet-ff-mac-scheduler`, the UEs are all placed at the same distance from the eNB, and hence all placed in order to have the same SNR. Different test cases are implemented by using a different SNR value and a different number of UEs. The test consists on checking that the obtained throughput performance matches with the known reference throughput up to a given tolerance. In long term, the expected behavior of both TD-BET and FD-BET when all UEs have the same SNR is that each UE should get an equal throughput. However, the exact throughput value of TD-BET and FD-BET in this test case is not the same.

When all UEs have the same SNR, TD-BET can be seen as a specific case of PF where achievable rate equals to 1. Therefore, the throughput obtained by TD-BET is equal to that of PF. On the other hand, FD-BET performs very similar to the round robin (RR) scheduler in case of that all UEs have the same SNR and the number of UE (or RBG) is an integer multiple of the number of RBG (or UE). In this case, FD-BET always allocate the same number of RBGs to each UE. For example, if eNB has 12 RBGs and there are 6 UEs, then each UE will get 2 RBGs in each TTI. Or if eNB has 12 RBGs and there are 24 UEs, then each UE will get 2 RBGs per two TTIs. When the number of UE (RBG) is not an integer multiple of the number of RBG (UE), FD-BET will not follow the RR behavior because it will assigned different number of RBGs to some UEs, while the throughput of each UE is still the same.

The second category of tests aims at verifying the fairness of the both TD-BET and FD-BET schedulers in a more

realistic simulation scenario where the UEs have a different SNR (constant for the whole simulation). In this case, both scheduler should give the same amount of averaged throughput to each user.

Specifically, for TD-BET, let  $F_i$  be the fraction of time allocated to user  $i$  in total simulation time,  $R_i^{fb}$  be the full bandwidth achievable rate for user  $i$  and  $T_i$  be the achieved throughput of user  $i$ . Then we have:

$$T_i = F_i R_i^{fb}$$

In TD-BET, the sum of  $F_i$  for all user equals one. In long term, all UE has the same  $T_i$  so that we replace  $T_i$  by  $T$ . Then we have:

$$T = \frac{1}{\sum_{i=1}^N \frac{1}{R_i^{fb}}}$$

### Token Band Fair Queue scheduler performance

Test suites `lte-fdtbfq-ff-mac-scheduler` and `lte-tdtbfq-ff-mac-scheduler` create different test cases for testing three key features of TBFQ scheduler: traffic policing, fairness and traffic balance. Constant Bit Rate UDP traffic is used in both downlink and uplink in all test cases. The packet interval is set to 1ms to keep the RLC buffer non-empty. Different traffic rate is achieved by setting different packet size. Specifically, two classes of flows are created in the test suites:

- Homogeneous flow: flows with the same token generation rate and packet arrival rate
- Heterogeneous flow: flows with different packet arrival rate, but with the same token generation rate

In test case 1 verifies traffic policing and fairness features for the scenario that all UEs are placed at the same distance from the eNB. In this case, all Ues have the same SNR value. Different test cases are implemented by using a different SNR value and a different number of UEs. Because each flow have the same traffic rate and token generation rate, TBFQ scheduler will guarantee the same throughput among UEs without the constraint of token generation rate. In addition, the exact value of UE throughput is depended on the total traffic rate:

- If total traffic rate  $\leq$  maximum throughput, UE throughput = traffic rate
- If total traffic rate  $>$  maximum throughput, UE throughput = maximum throughput / N

Here, N is the number of UE connected to eNodeB. The maximum throughput in this case equals to the rate that all RBGs are assigned to one UE(e.g., when distance equals 0, maximum throughput is 2196000 byte/sec). When the traffic rate is smaller than max bandwidth, TBFQ can police the traffic by token generation rate so that the UE throughput equals its actual traffic rate (token generation rate is set to traffic generation rate); On the other hand, when total traffic rate is bigger than the max throughput, eNodeB cannot forward all traffic to UEs. Therefore, in each TTI, TBFQ will allocate all RBGs to one UE due to the large packets buffered in RLC buffer. When a UE is scheduled in current TTI, its token counter is decreased so that it will not be scheduled in the next TTI. Because each UE has the same traffic generation rate, TBFQ will serve each UE in turn and only serve one UE in each TTI (both in TD TBFQ and FD TBFQ). Therefore, the UE throughput in the second condition equals to the evenly share of maximum throughput.

Test case 2 verifies traffic policing and fairness features for the scenario that each UE is placed at the different distance from the eNB. In this case, each UE has the different SNR value. Similar to test case 1, UE throughput in test case 2 is also depended on the total traffic rate but with a different maximum throughput. Suppose all UEs have a high traffic load. Then the traffic will saturate the RLC buffer in eNodeB. In each TTI, after selecting one UE with highest metric, TBFQ will allocate all RBGs to this UE due to the large RLC buffer size. On the other hand, once RLC buffer is saturated, the total throughput of all UEs cannot increase any more. In addition, as we discussed in test case 1, for homogeneous flows which have the same  $t_i$  and  $r_i$ , each UE will achieve the same throughput in long term. Therefore, we can use the same method in TD BET to calculate the maximum throughput:

$$T = \frac{N}{\sum_{i=1}^N \frac{1}{R_i^{fb}}}$$



Here,  $T$  is the maximum throughput.  $R_i^{fb}$  be the full bandwidth achievable rate for user  $i$ .  $N$  is the number of UE.

When the total traffic rate is bigger than  $T$ , the UE throughput equals to  $\frac{T}{N}$ . Otherwise, UE throughput equals to its traffic generation rate.

In test case 3, three flows with different traffic rate are created. Token generation rate for each flow is the same and equals to the average traffic rate of three flows. Because TBFQ use a shared token bank, tokens contributed by UE with lower traffic load can be utilized by UE with higher traffic load. In this way, TBFQ can guarantee the traffic rate for each flow. Although we use heterogeneous flow here, the calculation of maximum throughput is as same as that in test case 2. In calculation max throughput of test case 2, we assume that all UEs suffer high traffic load so that scheduler always assign all RBGs to one UE in each TTI. This assumes is also true in heterogeneous flow case. In other words, whether those flows have the same traffic rate and token generation rate, if their traffic rate is bigger enough, TBFQ performs as same as it in test case 2. Therefore, the maximum bandwidth in test case 3 is as same as it in test case 2.

In test case 3, in some flows, token generate rate does not equal to MBR, although all flows are CBR traffic. This is not accorded with our parameter setting rules. Actually, the traffic balance feature is used in VBR traffic. Because different UE's peak rate may occur in different time, TBFQ use shared token bank to balance the traffic among those VBR traffics. Test case 3 use CBR traffic to verify this feature. But in the real simulation, it is recommended to set token generation rate to MBR.

### Priority Set scheduler performance

Test suites `lte-pss-ff-mac-scheduler` create different test cases with a single eNB and several UEs. In all test cases, we select PFsch in FD scheduler. Same testing results can also be obtained by using CoItA scheduler. In addition, all test cases do not define nMux so that TD scheduler in PSS will always select half of total UE.

In the first class test case of `lte-pss-ff-mac-scheduler`, the UEs are all placed at the same distance from the eNB, and hence all placed in order to have the same SNR. Different test cases are implemented by using a different TBR for each UEs. In each test cases, all UEs have the same Target Bit Rate configured by GBR in EPS bear setting. The expected behavior of PSS is to guarantee that each UE's throughput at least equals its TBR if the total flow rate is blow maximum throughput. Similar to TBFQ, the maximum throughput in this case equals to the rate that all RBGs are assigned to one UE. When the traffic rate is smaller than max bandwidth, the UE throughput equals its actual traffic rate; On the other hand, UE throughput equals to the evenly share of the maximum throughput.

In the first class of test cases, each UE has the same SNR. Therefore, the priority metric in PF scheduler will be determined by past average throughput  $T_j(t)$  because each UE has the same achievable throughput  $R_j(k, t)$  in PFsch or same  $CoI[k, n]$  in CoItA. This means that PSS will performs like a TD-BET which allocates all RBGs to one UE in each TTI. Then the maximum value of UE throughput equals to the achievable rate that all RBGs are allocated to this UE.

In the second class of test case of `lte-pss-ff-mac-scheduler`, the UEs are all placed at the same distance from the eNB, and hence all placed in order to have the same SNR. Different TBR values are assigned to each UE. There also exist an maximum throughput in this case. Once total traffic rate is bigger than this threshold, there will be some UEs that cannot achieve their TBR. Because there is no fading, subband CQIs for each RBGs frequency are the same. Therefore, in FD scheduler, in each TTI, priority metrics of UE for all RBGs are the same. This means that FD scheduler will always allocate all RBGs to one user. Therefore, in the maximum throughput case, PSS performs like a TD-BET. Then we have:

$$T = \frac{N}{\sum_{i=1}^N \frac{1}{R_i^{fb}}}$$

Here,  $T$  is the maximum throughput.  $R_i^{fb}$  be the full bandwidth achievable rate for user  $i$ .  $N$  is the number of UE.

## Channel and QoS aware scheduler performance

The performance of the Channel and QoS aware scheduler can be tested in the similar way to performance of Priority Set scheduler when GBR flows are not delay sensitive by measuring if the achieved throughput at RLC layer is close to the TBR. Having this in mind, the performance of the CQA scheduler is tested by using the same test cases as the `lte-pss-ff-mac-scheduler`. Additionally, in [Bbojovic2014] can be found performance evaluation of CQA scheduler when the GBR flows are delay sensitive by considering different QoE metrics.

## Building Propagation Loss Model

The aim of the system test is to verify the integration of the `BuildingPathlossModel` with the `Lte` module. The test exploits a set of three pre calculated losses for generating the expected SINR at the receiver counting the transmission and the noise powers. These SINR values are compared with the results obtained from a LTE simulation that uses the `BuildingPathlossModel`. The reference loss values are calculated off-line with an Octave script (`/test/reference/lte_pathloss.m`). Each test case passes if the reference loss value is equal to the value calculated by the simulator within a tolerance of 0.001 dB, which accounts for numerical errors in the calculations.

## Physical Error Model

The test suite `lte-phy-error-model` generates different test cases for evaluating both data and control error models. For what concern the data, the test consists of six test cases with single eNB and a various number of UEs, all having the same Radio Bearer specification. Each test is designed for evaluating the error rate perceived by a specific TB size in order to verify that it corresponds to the expected values according to the BLER generated for CB size analog to the TB size. This means that, for instance, the test will check that the performance of a TB of  $N$  bits is analogous to the one of a CB size of  $N$  bits by collecting the performance of a user which has been forced the generation of a such TB size according to the distance to eNB. In order to significantly test the BLER at MAC level, we configured the Adaptive Modulation and Coding (AMC) module, the `LteAmc` class, for making it less robust to channel conditions by using the PiroEW2010 AMC model and configuring it to select the MCS considering a target BER of 0.03 (instead of the default value of 0.00005). We note that these values do not reflect the actual BER, since they come from an analytical bound which does not consider all the transmission chain aspects; therefore the BER and BLER actually experienced at the reception of a TB is in general different.

The parameters of the six test cases are reported in the following:

1. 4 UEs placed 1800 meters far from the eNB, which implies the use of MCS 2 (SINR of -5.51 dB) and a TB of 256 bits, that in turns produce a BLER of 0.33 (see point A in figure *BLER for tests 1, 2, 3*).
2. 2 UEs placed 1800 meters far from the eNB, which implies the use of MCS 2 (SINR of -5.51 dB) and a TB of 528 bits, that in turns produce a BLER of 0.11 (see point B in figure *BLER for tests 1, 2, 3*).
3. 1 UE placed 1800 meters far from the eNB, which implies the use of MCS 2 (SINR of -5.51 dB) and a TB of 1088 bits, that in turns produce a BLER of 0.02 (see point C in figure *BLER for tests 1, 2, 3*).
4. 1 UE placed 600 meters far from the eNB, which implies the use of MCS 12 (SINR of 4.43 dB) and a TB of 4800 bits, that in turns produce a BLER of 0.3 (see point D in figure *BLER for tests 4, 5*).
5. 3 UEs placed 600 meters far from the eNB, which implies the use of MCS 12 (SINR of 4.43 dB) and a TB of 1632 bits, that in turns produce a BLER of 0.55 (see point E in figure *BLER for tests 4, 5*).
6. 1 UE placed 470 meters far from the eNB, which implies the use of MCS 16 (SINR of 8.48 dB) and a TB of 7272 bits (segmented in 2 CBs of 3648 and 3584 bits), that in turns produce a BLER of 0.14, since each CB has CBLER equal to 0.075 (see point F in figure *BLER for test 6*).

The test condition verifies that in each test case the expected number of packets received correctly corresponds to a Bernoulli distribution with a confidence interval of 99%, where the probability of success in each trail is  $p = 1 - BER$  and  $n$  is the total number of packets sent.

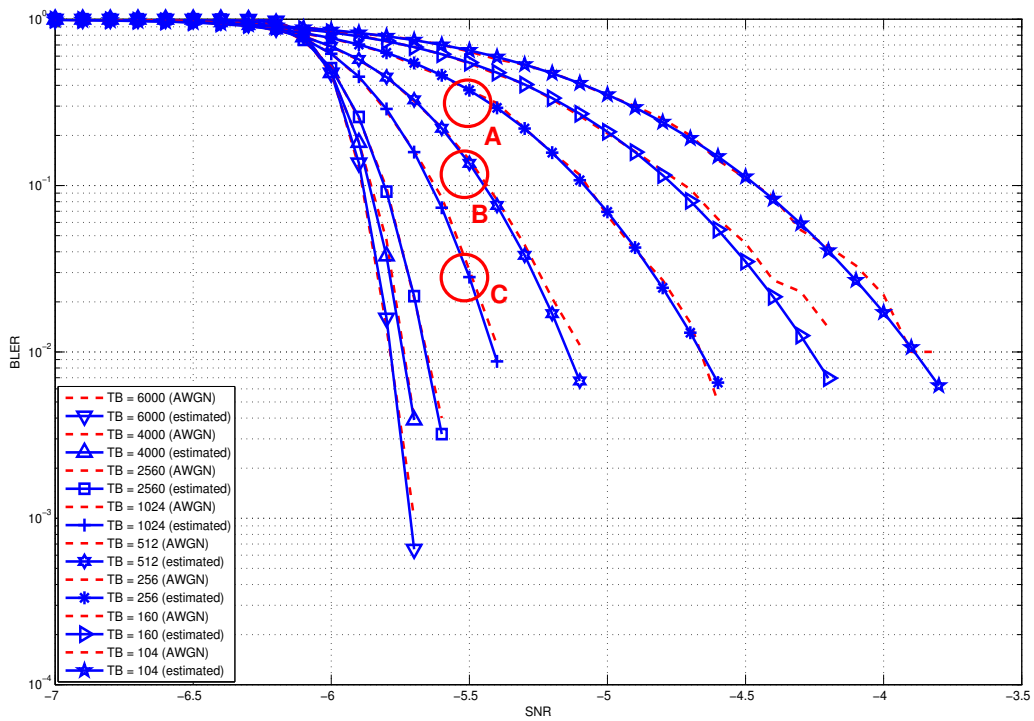

Fig. 94: BLER for tests 1, 2, 3.

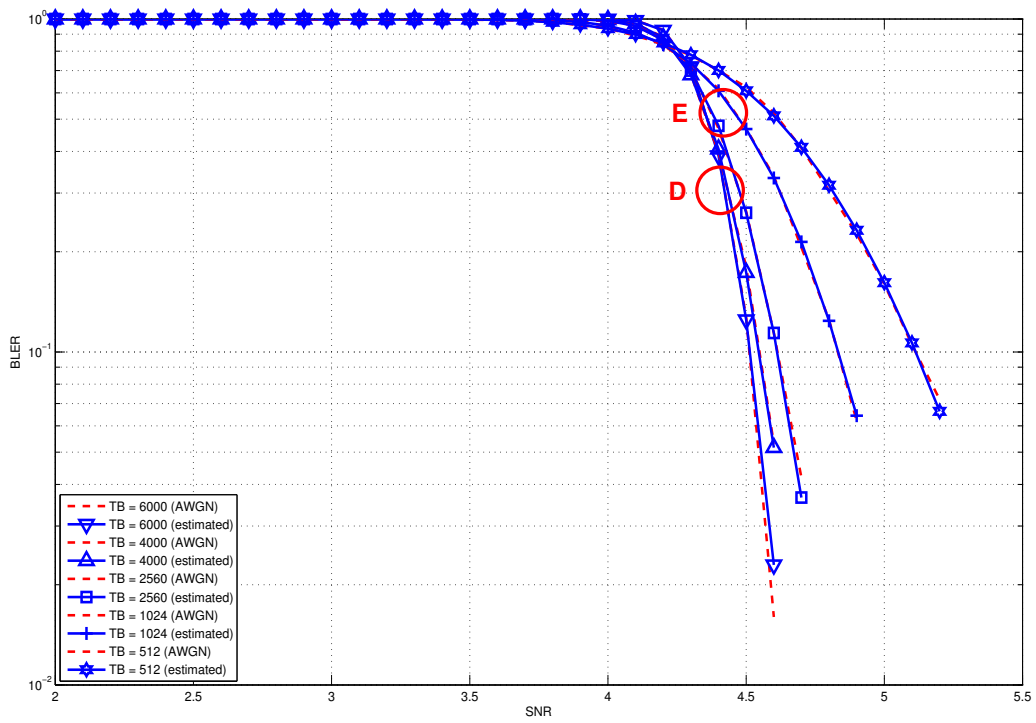

Fig. 95: BLER for tests 4, 5.

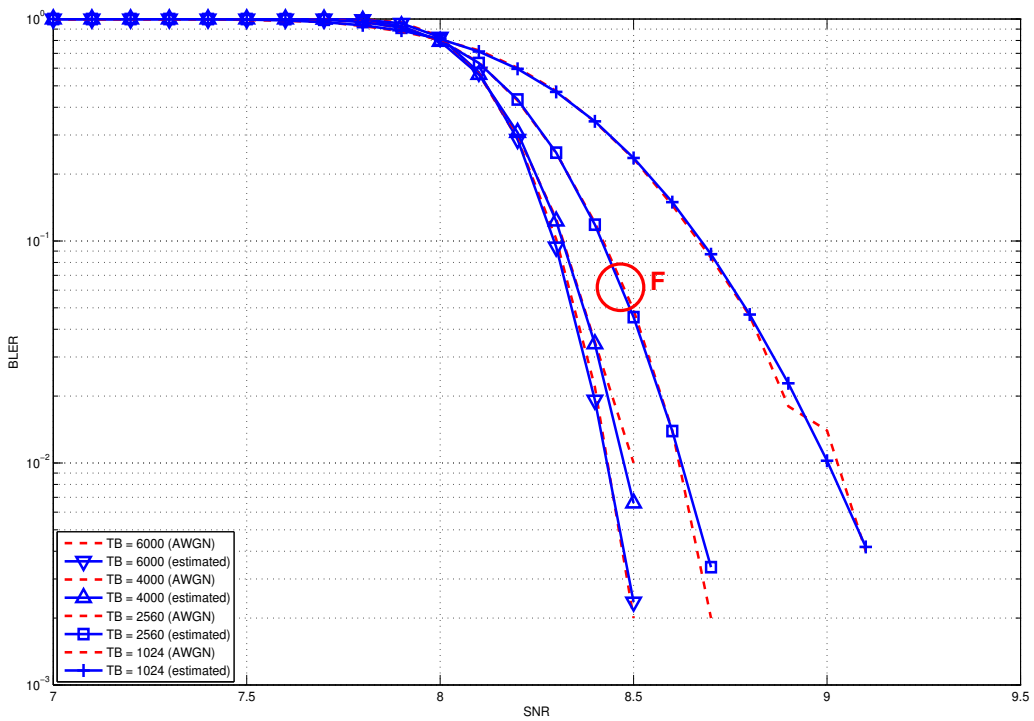

Fig. 96: BLER for test 6.

The error model of PCFICH-PDCCH channels consists of 4 test cases with a single UE and several eNBs, where the UE is connected to only one eNB in order to have the remaining acting as interfering ones. The errors on data are disabled in order to verify only the ones due to erroneous decoding of PCFICH-PDCCH. As before, the system has been forced on working in a less conservative fashion in the AMC module for appreciating the results in border situations. The parameters of the 4 tests cases are reported in the following:

1. 2 eNBs placed 1078 meters far from the UE, which implies a SINR of -2.00 dB and a TB of 217 bits, that in turns produce a BLER of 0.007.
2. 3 eNBs placed 1040 meters far from the UE, which implies a SINR of -4.00 dB and a TB of 217 bits, that in turns produce a BLER of 0.045.
3. 4 eNBs placed 1250 meters far from the UE, which implies a SINR of -6.00 dB and a TB of 133 bits, that in turns produce a BLER of 0.206.
4. 5 eNBs placed 1260 meters far from the UE, which implies a SINR of -7.00 dB and a TB of 81 bits, that in turns produce a BLER of 0.343.

The test condition verifies that in each test case the expected number of packets received correct corresponds to a Bernoulli distribution with a confidence interval of 99.8%, where the probability of success in each trail is  $p = 1 - BER$  and  $n$  is the total number of packet sent. The larger confidence interval is due to the errors that might be produced in quantizing the MI and the error curve.

### HARQ Model

The test suite `lte-harq` includes two tests for evaluating the HARQ model and the related extension in the error model. The test consists on checking whether the amount of bytes received during the simulation corresponds to the expected ones according to the values of transport block and the HARQ dynamics. In detail, the test checks whether the throughput obtained after one HARQ retransmission is the expected one. For evaluating the expected throughput the expected TB delivering time has been evaluated according to the following formula:

$$T = P_s^1 \times 1 + P_s^2 \times 2 + (1 - P_s^2) \times 3$$

where  $P_s^i$  is the probability of receiving with success the HARQ block at the attempt  $i$  (i.e., the RV with 3GPP naming). According to the scenarios, in the test we always have  $P_s^1$  equal to 0.0, while  $P_s^2$  varies in the two tests, in detail:

$$\begin{aligned} T_{\text{test-1}} &= 0.0 \times 1 + 0.926 \times 2 + 0.074 \times 3 = 2.074 \\ T_{\text{test-2}} &= 0.0 \times 1 + 0.752 \times 2 + 0.248 \times 3 = 2.248 \end{aligned}$$

The expected throughput is calculated by counting the number of transmission slots available during the simulation (e.g., the number of TTIs) and the size of the TB in the simulation, in detail:

$$\text{Thr}_{\text{test-i}} = \frac{TTI_{NUM}}{T_{\text{test-i}}} TB_{\text{size}} = \begin{cases} \frac{1000}{2.074} 66 = 31822 \text{ bps} & \text{for test-1} \\ \frac{1000}{2.248} 472 = 209964 \text{ bps} & \text{for test-2} \end{cases}$$

where  $TTI_{NUM}$  is the total number of TTIs in 1 second. The test is performed both for Round Robin scheduler. The test passes if the measured throughput matches with the reference throughput within a relative tolerance of 0.1. This tolerance is needed to account for the transient behavior at the beginning of the simulation and the on-fly blocks at the end of the simulation.

### MIMO Model

The test suite `lte-mimo` aims at verifying both the effect of the gain considered for each Transmission Mode on the system performance and the Transmission Mode switching through the scheduler interface. The test consists on

checking whether the amount of bytes received during a certain window of time (0.1 seconds in our case) corresponds to the expected ones according to the values of transport block size reported in table 7.1.7.2.1-1 of [TS36213], similarly to what done for the tests of the schedulers.

The test is performed both for Round Robin and Proportional Fair schedulers. The test passes if the measured throughput matches with the reference throughput within a relative tolerance of 0.1. This tolerance is needed to account for the transient behavior at the beginning of the simulation and the transition phase between the Transmission Modes.

## Antenna Model integration

The test suite *lte-antenna* checks that the AntennaModel integrated with the LTE model works correctly. This test suite recreates a simulation scenario with one eNB node at coordinates (0,0,0) and one UE node at coordinates (x,y,0). The eNB node is configured with an CosineAntennaModel having given orientation and beamwidth. The UE instead uses the default IsotropicAntennaModel. The test checks that the received power both in uplink and downlink account for the correct value of the antenna gain, which is determined offline; this is implemented by comparing the uplink and downlink SINR and checking that both match with the reference value up to a tolerance of  $10^{-6}$  which accounts for numerical errors. Different test cases are provided by varying the x and y coordinates of the UE, and the beamwidth and the orientation of the antenna of the eNB.

## RLC

Two test suites `lte-rlc-um-transmitter` and `lte-rlc-am-transmitter` check that the UM RLC and the AM RLC implementation work correctly. Both these suites work by testing RLC instances connected to special test entities that play the role of the MAC and of the PDCP, implementing respectively the `LteMacSapProvider` and `LteRlcSapUser` interfaces. Different test cases (i.e., input test vector consisting of series of primitive calls by the MAC and the PDCP) are provided that check the behavior in the following cases:

1. one SDU, one PDU: the MAC notifies a TX opportunity causes the creation of a PDU which exactly contains a whole SDU
2. segmentation: the MAC notifies multiple TX opportunities that are smaller than the SDU size stored in the transmission buffer, which is then to be fragmented and hence multiple PDUs are generated;
3. concatenation: the MAC notifies a TX opportunity that is bigger than the SDU, hence multiple SDUs are concatenated in the same PDU
4. buffer status report: a series of new SDUs notifications by the PDCP is interleaved with a series of TX opportunity notification in order to verify that the buffer status report procedure is correct.

In all these cases, an output test vector is determine manually from knowledge of the input test vector and knowledge of the expected behavior. These test vector are specialized for UM RLC and AM RLC due to their different behavior. Each test case passes if the sequence of primitives triggered by the RLC instance being tested is exactly equal to the output test vector. In particular, for each PDU transmitted by the RLC instance, both the size and the content of the PDU are verified to check for an exact match with the test vector.

The AM RLC implementation features an additional test suite, `lte-rlc-am-e2e`, which test the correct retransmission of RLC PDUs in presence of channel losses. The test instantiates an RLC AM transmitter and a receiver, and interposes a channel that randomly drops packet according to a fixed loss probability. Different test cases are instantiated using different `RngRun` values and different loss probability values. Each test case passes if at the end of the simulation all SDUs are correctly delivered to the upper layers of the receiving RLC AM entity.

## RRC

The test suite `lte-rrc` tests the correct functionality of the following aspects:

1. MAC Random Access
2. RRC System Information Acquisition
3. RRC Connection Establishment
4. RRC Reconfiguration

The test suite considers a type of scenario with four eNBs aligned in a square layout with 100-meter edges. Multiple UEs are located at a specific spot on the diagonal of the square and are instructed to connect to the first eNB. Each test case implements an instance of this scenario with specific values of the following parameters:

- number of UEs
- number of Data Radio Bearers to be activated for each UE
- time  $t_0^c$  at which the first UE is instructed to start connecting to the eNB
- time interval  $d^i$  between the start of connection of UE  $n$  and UE  $n + 1$ ; the time at which user  $n$  connects is thus determined as  $t_n^c = t_0^c + n d^i$  sdf
- the relative position of the UEs on the diagonal of the square, where higher values indicate larger distance from the serving eNodeB, i.e., higher interference from the other eNodeBs
- a boolean flag indicating whether the ideal or the real RRC protocol model is used

Each test cases passes if a number of test conditions are positively evaluated for each UE after a delay  $d^e$  from the time it started connecting to the eNB. The delay  $d^e$  is determined as

$$d^e = d^{si} + d^{ra} + d^{ce} + d^{cr}$$

where:

- $d^{si}$  is the max delay necessary for the acquisition of System Information. We set it to 90ms accounting for 10ms for the MIB acquisition and 80ms for the subsequent SIB2 acquisition
- $d^{ra}$  is the delay for the MAC Random Access (RA) procedure. This depends on preamble collisions as well as on the availability of resources for the UL grant allocation. The total amount of necessary RA attempts depends on preamble collisions and failures to allocate the UL grant because of lack of resources. The number of collisions depends on the number of UEs that try to access simultaneously; we estimated that for a 0.99 RA success probability, 5 attempts are sufficient for up to 20 UEs, and 10 attempts for up to 50 UEs. For the UL grant, considered the system bandwidth and the default MCS used for the UL grant (MCS 0), at most 4 UL grants can be assigned in a TTI; so for  $n$  UEs trying to do RA simultaneously the max number of attempts due to the UL grant issue is  $\lceil n/4 \rceil$ . The time for a RA attempt is determined by 3ms + the value of `LteEnbMac::RaResponseWindowSize`, which defaults to 3ms, plus 1ms for the scheduling of the new transmission.
- $d^{ce}$  is the delay required for the transmission of RRC CONNECTION SETUP + RRC CONNECTION SETUP COMPLETED. We consider a round trip delay of 10ms plus  $\lceil 2n/4 \rceil$  considering that 2 RRC packets have to be transmitted and that at most 4 such packets can be transmitted per TTI. In cases where interference is high, we accommodate one retry attempt by the UE, so we double the  $d^{ce}$  value and then add  $d^{si}$  on top of it (because the timeout has reset the previously received SIB2).
- $d^{cr}$  is the delay required for eventually needed RRC CONNECTION RECONFIGURATION transactions. The number of transactions needed is 1 for each bearer activation. Similarly to what done for  $d^{ce}$ , for each transaction we consider a round trip delay of 10ms plus  $\lceil 2n/4 \rceil$ . delay of 20ms.

The base version of the test `LteRrcConnectionEstablishmentTestCase` tests for correct RRC connection establishment in absence of channel errors. The conditions that are evaluated for this test case to pass are, for each UE:

- the RRC state at the UE is `CONNECTED_NORMALLY`
- the UE is configured with the `CellId`, `DIBandwidth`, `UIBandwidth`, `DIEarfcn` and `UIEarfcn` of the eNB



- the IMSI of the UE stored at the eNB is correct
- the number of active Data Radio Bearers is the expected one, both at the eNB and at the UE
- for each Data Radio Bearer, the following identifiers match between the UE and the eNB: EPS bearer id, DRB id, LCID

The test variant `LteRrcConnectionEstablishmentErrorTestCase` is similar except for the presence of errors in the transmission of a particular RRC message of choice during the first connection attempt. The error is obtained by temporarily moving the UE to a far away location; the time of movement has been determined empirically for each instance of the test case based on the message that it was desired to be in error. The test case checks that at least one of the following conditions is false at the time right before the UE is moved back to the original location:

- the RRC state at the UE is `CONNECTED_NORMALLY`
- the UE context at the eNB is present
- the RRC state of the UE Context at the eNB is `CONNECTED_NORMALLY`

### Initial cell selection

The test suite `lte-cell-selection` is responsible for verifying the *Initial Cell Selection* procedure. The test is a simulation of a small network of 2 non-CSG cells and 2 non-CSG cells. Several static UEs are then placed at predefined locations. The UEs enter the simulation without being attached to any cell. Initial cell selection is enabled for these UEs, so each UE will find the best cell and attach to it by themselves.

At predefined check points time during the simulation, the test verifies that every UE is attached to the right cell. Moreover, the test also ensures that the UE is properly connected, i.e., its final state is `CONNECTED_NORMALLY`. Figure *Sample result of cell selection test* depicts the network layout and the expected result. When a UE is depicted as having 2 successful cell selections (e.g., UE #3 and #4), any of them is accepted by the test case.

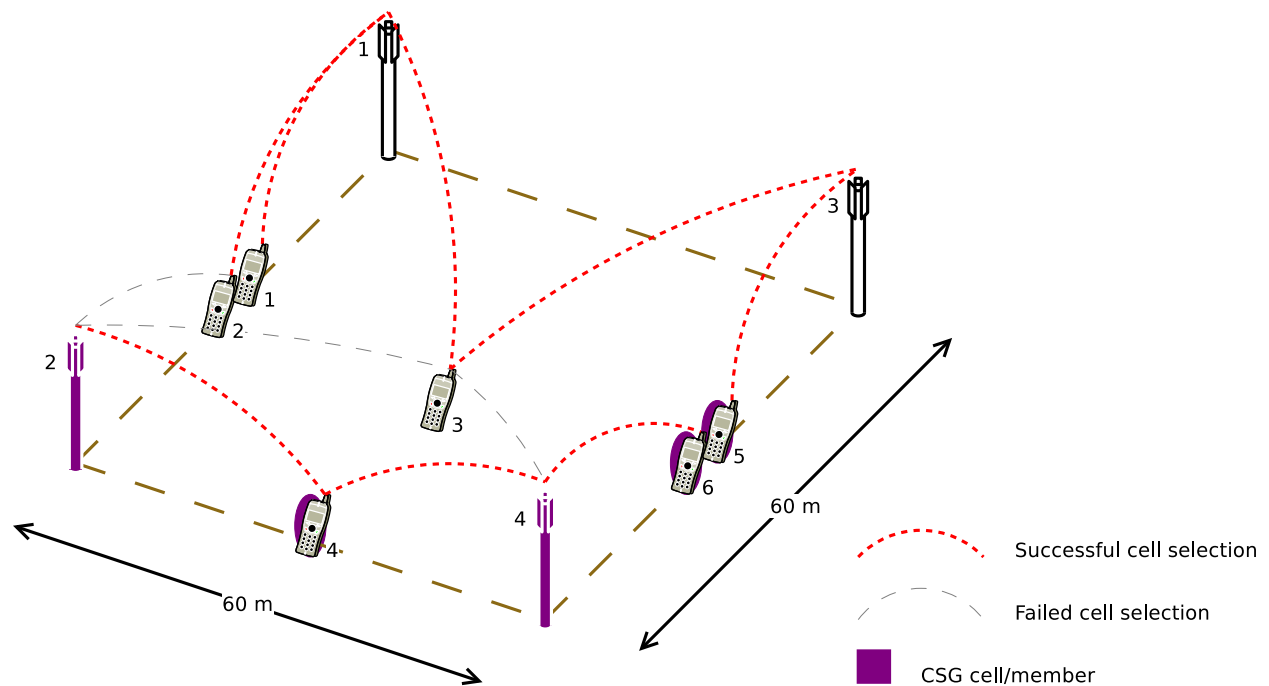

Fig. 97: Sample result of cell selection test

The figure shows that CSG members may attach to either CSG or non-CSG cells, and simply choose the stronger one.

On the other hand, non-members can only attach to non-CSG cells, even when they are actually receiving stronger signal from a CSG cell.

For reference purpose, Table *UE error rate in Initial Cell Selection test* shows the error rate of each UE when receiving transmission from the control channel. Based on this information, the check point time for UE #3 is done at a later time than the others to compensate for its higher risk of failure.

Table 10: UE error rate in Initial Cell Selection test

UE #	Error rate
1	0.00%
2	1.44%
3	12.39%
4	0.33%
5	0.00%
6	0.00%

The test uses the default Friis path loss model and without any channel fading model.

### GTP-U protocol

The unit test suite `epc-gtpu` checks that the encoding and decoding of the GTP-U header is done correctly. The test fills in a header with a set of known values, adds the header to a packet, and then removes the header from the packet. The test fails if, upon removing, any of the fields in the GTP-U header is not decoded correctly. This is detected by comparing the decoded value from the known value.

### S1-U interface

Two test suites (`epc-slu-uplink` and `epc-slu-downlink`) make sure that the S1-U interface implementation works correctly in isolation. This is achieved by creating a set of simulation scenarios where the EPC model alone is used, without the LTE model (i.e., without the LTE radio protocol stack, which is replaced by simple CSMA devices). This checks that the interoperation between multiple `EpcEnbApplication` instances in multiple eNBs and the `EpcSgwPgwApplication` instance in the SGW/PGW node works correctly in a variety of scenarios, with varying numbers of end users (nodes with a CSMA device installed), eNBs, and different traffic patterns (packet sizes and number of total packets). Each test case works by injecting the chosen traffic pattern in the network (at the considered UE or at the remote host for in the uplink or the downlink test suite respectively) and checking that at the receiver (the remote host or each considered UE, respectively) that exactly the same traffic patterns is received. If any mismatch in the transmitted and received traffic pattern is detected for any UE, the test fails.

### TFT classifier

The test suite `epc-tft-classifier` checks in isolation that the behavior of the `EpcTftClassifier` class is correct. This is performed by creating different classifier instances where different TFT instances are activated, and testing for each classifier that an heterogeneous set of packets (including IP and TCP/UDP headers) is classified correctly. Several test cases are provided that check the different matching aspects of a TFT (e.g. local/remote IP address, local/remote port) both for uplink and downlink traffic. Each test case corresponds to a specific packet and a specific classifier instance with a given set of TFTs. The test case passes if the bearer identifier returned by the classifier exactly matches with the one that is expected for the considered packet.

## End-to-end LTE-EPC data plane functionality

The test suite `lte-epc-e2e-data` ensures the correct end-to-end functionality of the LTE-EPC data plane. For each test case in this suite, a complete LTE-EPC simulation scenario is created with the following characteristics:

- a given number of eNBs
- for each eNB, a given number of UEs
- for each UE, a given number of active EPS bearers
- for each active EPS bearer, a given traffic pattern (number of UDP packets to be transmitted and packet size)

Each test is executed by transmitting the given traffic pattern both in the uplink and in the downlink, at subsequent time intervals. The test passes if all the following conditions are satisfied:

- for each active EPS bearer, the transmitted and received traffic pattern (respectively at the UE and the remote host for uplink, and vice versa for downlink) is exactly the same
- for each active EPS bearer and each direction (uplink or downlink), exactly the expected number of packet flows over the corresponding RadioBearer instance

## X2 handover

The test suite `lte-x2-handover` checks the correct functionality of the X2 handover procedure. The scenario being tested is a topology with two eNBs connected by an X2 interface. Each test case is a particular instance of this scenario defined by the following parameters:

- the number of UEs that are initially attached to the first eNB
- the number of EPS bearers activated for each UE
- a list of handover events to be triggered, where each event is defined by: + the start time of the handover trigger + the index of the UE doing the handover + the index of the source eNB + the index of the target eNB
- a boolean flag indicating whether the target eNB admits the handover or not
- a boolean flag indicating whether the ideal RRC protocol is to be used instead of the real RRC protocol
- the type of scheduler to be used (RR or PF)

Each test case passes if the following conditions are true:

- at time 0.06s, the test `CheckConnected` verifies that each UE is connected to the first eNB
- for each event in the handover list:
  - at the indicated event start time, the indicated UE is connected to the indicated source eNB
  - 0.1s after the start time, the indicated UE is connected to the indicated target eNB
  - 0.6s after the start time, for each active EPS bearer, the uplink and downlink sink applications of the indicated UE have achieved a number of bytes which is at least half the number of bytes transmitted by the corresponding source applications

The condition “UE is connected to eNB” is evaluated positively if and only if all the following conditions are met:

- the eNB has the context of the UE (identified by the RNTI value retrieved from the UE RRC)
- the RRC state of the UE at the eNB is `CONNECTED_NORMALLY`
- the RRC state at the UE is `CONNECTED_NORMALLY`
- the UE is configured with the `CellId`, `DlBandwidth`, `UlBandwidth`, `DlEarfcn` and `UlEarfcn` of the eNB

- the IMSI of the UE stored at the eNB is correct
- the number of active Data Radio Bearers is the expected one, both at the eNB and at the UE
- for each Data Radio Bearer, the following identifiers match between the UE and the eNB: EPS bearer id, DRB id, LCID

### Automatic X2 handover

The test suite `lte-x2-handover-measures` checks the correct functionality of the handover algorithm. The scenario being tested is a topology with two, three or four eNBs connected by an X2 interface. The eNBs are located in a straight line in the X-axes. A UE moves along the X-axes going from the neighborhood of one eNB to the next eNB. Each test case is a particular instance of this scenario defined by the following parameters:

- the number of eNBs in the X-axes
- the number of UEs
- the number of EPS bearers activated for the UE
- a list of check point events to be triggered, where each event is defined by: + the time of the first check point event + the time of the last check point event + interval time between two check point events + the index of the UE doing the handover + the index of the eNB where the UE must be connected
- a boolean flag indicating whether UDP traffic is to be used instead of TCP traffic
- the type of scheduler to be used
- the type of handover algorithm to be used
- a boolean flag indicating whether handover is admitted by default
- a boolean flag indicating whether the ideal RRC protocol is to be used instead of the real RRC protocol

The test suite consists of many test cases. In fact, it has been one of the most time-consuming test suite in ns-3. The test cases run with *some* combination of the following variable parameters:

- number of eNBs: 2, 3, 4;
- number of EPS bearers: 0, 1, 2;
- RRC: ideal, real (see *RRC protocol models*);
- MAC scheduler: round robin, proportional fair (see *The FemtoForum MAC Scheduler Interface*); and
- handover algorithm: A2-A4-RSRQ, strongest cell (see *Handover algorithm*).

Each test case passes if the following conditions are true:

- at time 0.08s, the test CheckConnected verifies that each UE is connected to the first eNB
- for each event in the check point list:
  - at the indicated check point time, the indicated UE is connected to the indicated eNB
  - 0.5s after the check point, for each active EPS bearer, the uplink and downlink sink applications of the UE have achieved a number of bytes which is at least half the number of bytes transmitted by the corresponding source applications

The condition “UE is connected to eNB” is evaluated positively if and only if all the following conditions are met:

- the eNB has the context of the UE (identified by the RNTI value retrieved from the UE RRC)
- the RRC state of the UE at the eNB is CONNECTED\_NORMALLY
- the RRC state at the UE is CONNECTED\_NORMALLY

- the UE is configured with the CellId, DIBandwidth, UIBandwidth, DIEarfcn and UIEarfcn of the eNB
- the IMSI of the UE stored at the eNB is correct
- the number of active Data Radio Bearers is the expected one, both at the eNB and at the UE
- for each Data Radio Bearer, the following identifiers match between the UE and the eNB: EPS bearer id, DRB id, LCID

## Handover delays

Handover procedure consists of several message exchanges between UE, source eNodeB, and target eNodeB over both RRC protocol and X2 interface. Test suite `lte-handover-delay` verifies that this procedure consistently spends the same amount of time.

The test suite will run several handover test cases. Each test case is an individual simulation featuring a handover at a specified time in simulation. For example, the handover in the first test case is invoked at time +0.100s, while in the second test case it is at +0.101s. There are 10 test cases, each testing a different subframe in LTE. Thus the last test case has the handover at +0.109s.

The simulation scenario in the test cases is as follow:

- EPC is enabled
- 2 eNodeBs with circular (isotropic) antenna, separated by 1000 meters
- 1 static UE positioned exactly in the center between the eNodeBs
- no application installed
- no channel fading
- default path loss model (Friis)
- 0.300s simulation duration

The test case runs as follow. At the beginning of the simulation, the UE is attached to the first eNodeB. Then at the time specified by the test case input argument, a handover request will be explicitly issued to the second eNodeB. The test case will then record the starting time, wait until the handover is completed, and then record the completion time. If the difference between the completion time and starting time is less than a predefined threshold, then the test passes.

A typical handover in the current ns-3 implementation takes 4.2141 ms when using Ideal RRC protocol model, and 19.9283 ms when using Real RRC protocol model. Accordingly, the test cases use 5 ms and 20 ms as the maximum threshold values. The test suite runs 10 test cases with Ideal RRC protocol model and 10 test cases with Real RRC protocol model. More information regarding these models can be found in Section *RRC protocol models*.

The motivation behind using subframes as the main test parameters is the fact that subframe index is one of the factors for calculating RA-RNTI, which is used by Random Access during the handover procedure. The test cases verify this computation, utilizing the fact that the handover will be delayed when this computation is broken. In the default simulation configuration, the handover delay observed because of a broken RA-RNTI computation is typically 6 ms.

## Selection of target cell in handover algorithm

eNodeB may utilize *Handover algorithm* to automatically create handover decisions during simulation. The decision includes the UE which should do the handover and the target cell where the UE should perform handover to.

The test suite `lte-handover-target` verifies that the handover algorithm is making the right decision, in particular, in choosing the right target cell. It consists of several short test cases for different network topology (2x2 grid and 3x2 grid) and types of handover algorithm (the A2-A4-RSRQ handover algorithm and the strongest cell handover algorithm).

Each test case is a simulation of a micro-cell environment with the following parameter:

- EPC is enabled
- several circular (isotropic antenna) micro-cell eNodeBs in a rectangular grid layout, with 130 m distance between each adjacent point
- 1 static UE, positioned close to and attached to the source cell
- no control channel error model
- no application installed
- no channel fading
- default path loss model (Friis)
- 1s simulation duration

To trigger a handover, the test case “shutdowns” the source cell at +0.5s simulation time. Figure *lte-handover-target test scenario in a 2x2 grid* below illustrates the process. This is done by setting the source cell’s Tx power to a very low value. As a result, the handover algorithm notices that the UE deserves a handover and several neighboring cells become candidates of target cell at the same time.

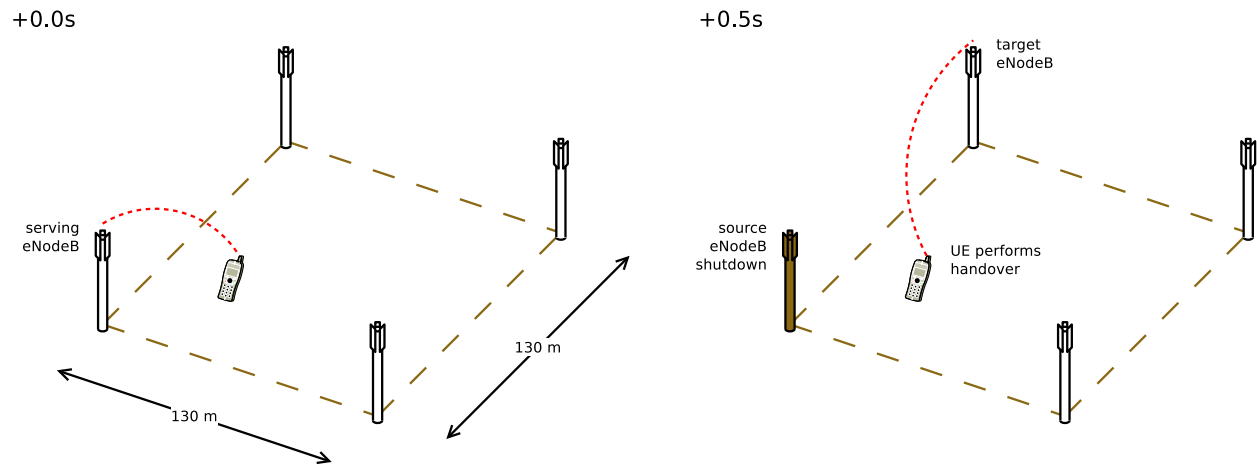

Fig. 98: lte-handover-target test scenario in a 2x2 grid

The test case then verifies that the handover algorithm, when faced with more than one options of target cells, is able to choose the right one.

## Downlink Power Control

The test suite `lte-downlink-power-control` checks correctness of Downlink Power Control in three different ways:

- `LteDownlinkPowerControlSpectrumValue` test case check if `LteSpectrumValueHelper::CreateTxPowerSpectralDensity` is creating correct spectrum value for PSD for downlink transmission. The test vector contain EARFCN, system bandwidth, TX power, TX power for each RB, active RBs, and expected TxPSD. The test passes if TxPDS generated by `LteSpectrumValueHelper::CreateTxPowerSpectralDensity` is equal to expected TxPSD.
- `LteDownlinkPowerControlTestCase` test case check if TX power difference between data and control channel is equal to configured `PdschConfigDedicated::P_A` value. TX power of control channel is measured by `LteTestSinrChunkProcessor` added to `RsPowerChunkProcessor` list in UE DownlinkSpec-

trumPhy. Tx power of data channel is measured in similar way, but it had to be implemented. Now `LteTestSinrChunkProcessor` is added to `DataPowerChunkProcessor` list in UE DownlinkSpectrumPhy. Test vector contain a set of all available P\_A values. Test pass if power difference equals P\_A value.

- `LteDownlinkPowerControlRrcConnectionReconfiguration` test case check if `RrcConnectionReconfiguration` is performed correctly. When FR entity gets UE measurements, it immediately calls function to change P\_A value for this UE and also triggers callback connected with this event. Then, test check if UE gets `RrcConnectionReconfiguration` message (it trigger callback). Finally, it checks if eNB receive `RrcConnectionReconfigurationCompleted` message, what also trigger callback. The test passes if all event have occurred. The test is performed two times, with `IdealRrcProtocol` and with `RealRrcProtocol`.

## Uplink Power Control Tests

UE uses Uplink Power Control to automatically change Tx Power level for Uplink Physical Channels. Tx Power is computed based on path-loss, number of RB used for transmission, some configurable parameters and TPC command from eNB.

The test suite `lte-uplink-power-control` verifies if Tx Power is computed correctly. There are three different test cases:

- `LteUplinkOpenLoopPowerControlTestCase` test case checks Uplink Power Control functionality in Open Loop mechanism. UE is attached to eNB and is transmitting data in Downlink and Uplink. Uplink Power Control with Open Loop mechanism is enabled and UE changes position each 100 ms. In each position Uplink Power Control entity is calculating new Tx Power level for all uplink channels. These values are traced and test passes if Uplink Tx Power for PUSCH, PUCCH and SRS in each UE position are equal to expected values.
- `LteUplinkClosedLoopPowerControlAbsoluteModeTestCase` test case checks Uplink Power Control functionality with Closed Loop mechanism and Absolute Mode enabled. UE is attached to eNB and is transmitting data in Downlink and Uplink. Uplink Power Control with Closed Loop mechanism and Absolute Mode is enabled. UE is located 100 m from eNB and is not changing its position. `LteFfrSimple` algorithm is used on eNB side to set TPC values in DL-DCI messages. TPC configuration in eNB is changed every 100 ms, so every 100 ms Uplink Power Control entity in UE should calculate different Tx Power level for all uplink channels. These values are traced and test passes if Uplink Tx Power for PUSCH, PUCCH and SRS computed with all TCP values are equal to expected values.
- `LteUplinkClosedLoopPowerControlAccumulatedModeTestCase` test case checks Closed Loop Uplink Power Control functionality with Closed Loop mechanism and Accumulative Mode enabled. UE is attached to eNB and is transmitting data in Downlink and Uplink. Uplink Power Control with Closed Loop mechanism and Accumulative Mode is enabled. UE is located 100 m from eNB and is not changing its position. As in above test case, `LteFfrSimple` algorithm is used on eNB side to set TPC values in DL-DCI messages, but in this case TPC command are set in DL-DCI only configured number of times, and after that TPC is set to be 1, what is mapped to value of 0 in Accumulative Mode (TS36.213 Table 5.1.1.1-2). TPC configuration in eNB is changed every 100 ms. UE is accumulating these values and calculates Tx Power levels for all uplink channels based on accumulated value. If computed Tx Power level is lower than minimal UE Tx Power, UE should transmit with its minimal Tx Power. If computed Tx Power level is higher than maximal UE Tx Power, UE should transmit with its maximal Tx Power. Tx Power levels for PUSCH, PUCCH and SRS are traced and test passes if they are equal to expected values.

## Frequency Reuse Algorithms

The test suite `lte-frequency-reuse` contain two types of test cases.

First type of test cases check if RBGs are used correctly according to FR algorithm policy. We are testing if scheduler use only RBGs allowed by FR configuration. To check which RBGs are used `LteSimpleSpectrumPhy` is attached to Downlink Channel. It notifies when data downlink channel transmission has occurred and pass signal TxPsd spectrum

value to check which RBs were used for transmission. The test vector comprise a set of configuration for Hard and Strict FR algorithms (there is no point to check other FR algorithms in this way because they use entire cell bandwidth). Test passes if none of not allowed RBGs are used.

Second type of test cases check if UE is served within proper sub-band and with proper transmission power. In this test scenario, there are two eNBs. There are also two UEs and each eNB is serving one. One uses Frequency Reuse algorithm and second one does not. Second eNB is responsible for generating interferences in whole system bandwidth. UE served by first eNB is changing position each few second (rather slow because time is needed to report new UE Measurements). To check which RBGs are used for this UE `LteSimpleSpectrumPhy` is attached to Downlink Channel. It notifies when data downlink channel transmission in cell 1 has occurred and pass signal `TxPsd` spectrum value to check which RBs were used for transmission and their power level. The same approach is applied in Uplink direction and second `LteSimpleSpectrumPhy` is attached to Uplink Channel. Test passes if UE served by eNB with FR algorithm is served in DL and UL with expected RBs and with expected power level. Test vector comprise a configuration for Strict FR, Soft FR, Soft FFR, Enhanced FFR. Each FR algorithm is tested with all schedulers, which support FR (i.e. PF, PSS, CQA, TD-TBFQ, FD-TBFQ). (Hard FR do not use UE measurements, so there is no point to perform this type of test for Hard FR).

Test case for Distributed FFR algorithm is quite similar to above one, but since eNBs need to exchange some information, scenario with EPC enabled and X2 interfaces is considered. Moreover, both eNB are using Distributed FFR algorithm. There are 2 UE in first cell, and 1 in second cell. Position of each UE is changed (rather slow because time is needed to report new UE Measurements), to obtain different result from calculation in Distributed FFR algorithm entities. To check which RBGs are used for UE transmission `LteSimpleSpectrumPhy` is attached to Downlink Channel. It notifies when data downlink channel transmission has occurred and pass signal `TxPsd` spectrum value to check which RBs were used for transmission and their power level. The same approach is applied in Uplink direction and second `LteSimpleSpectrumPhy` is attached to Uplink Channel. Test passes if UE served by eNB in cell 2, is served in DL and UL with expected RBs and with expected power level. Test vector comprise a configuration for Distributed FFR. Test is performed with all schedulers, which support FR (i.e. PF, PSS, CQA, TD-TBFQ, FD-TBFQ).

### Inter-cell Interference with FR algorithms Tests

The test suite `lte-interference-fr` is very similar to `lte-interference`. Topology (Figure *Topology for the inter-cell interference test*) is the same and test checks interference level. The difference is that, in this test case Frequency Reuse algorithms are enabled and we are checking interference level on different RBGs (not only on one). For example, when we install Hard FR algorithm in eNBs, and first half of system bandwidth is assigned to one eNB, and second half to second eNB, interference level should be much lower compared to legacy scenario. The test vector comprise a set of configuration for all available Frequency Reuse Algorithms. Test passes if calculated SINR on specific RBs is equal to these obtained by Octave script.

### Carrier aggregation test

The test suite `lte-carrier-aggregation` is a system test program that creates different test cases with a single eNB and several UEs, all having the same radio bearer specification. Different test cases are implemented by using different SINR values and different numbers of UEs. eNBs and UEs are configured to use the secondary carrier and the component carrier manager is configured to split the data uniformly between primary and secondary carrier. The test consists of checking that the throughput obtained over the different carriers are equal considering a given tolerance. For more details about this test, see the section Carrier aggregation usage example.

### Carrier aggregation test for eNB and UE configuration

The test suite `carrier-aggregation-config-test` is a system test program, which verifies the following two cases:



- When carrier aggregation is enabled and UE carriers configuration is different than the default configuration done in LteHelper, we check that the UE(s) is configured properly once it receives RRC Connection Reconfiguration message from eNB.
- A user can configure 2 or more eNBs and UEs with different configuration parameters, i.e., each eNB and UE can have different EARFCN and Bandwidths and a UE connects to an eNB with similar DL EARFCN. In this test, we check with CA enabled but the end results will be the same if carrier aggregation is not enabled and we have more than one eNBs and UEs with different configurations.

Since, we do not need EPC to test the configuration, this test only simulates the LTE radio access with RLC SM. There are two test cases, Test 1 tests that the UE is configured properly after receiving RRC Connection Reconfiguration message from the eNB, which will overwrite UE default configuration done in LteHelper for the sake of creating PHY and MAC instances equal to the number of component carriers. Test 2 tests that every eNB or UE in a simulation scenario can be configured with different EARFCNs and Bandwidths. For both test cases, it also counts the number of times the hooked trace source `SCarrierConfigured` get triggered. As, it reflects how many UEs got attached to their respective eNB. If the count is not equal to the number of UEs in the scenario, the test fails, which could be the result of improper UE configuration.

### Radio link failure Test

The test suite `lte-radio-link-failure` is a system test, which tests the radio link failure functionality using Ideal and Real RRC protocols. In particular, it tests the following to verify the Radio link Failure (RLF) implementation.

1. The state and the configuration of the UE while it is connected to the eNB.
2. The state of the UE while T310 timer is running at the UE.
3. The number of out-of-sync and in-sync indications received.
4. The state of the UE before the simulation end.
5. The UE context existence at the eNB before the simulation end.

This test simulates only one static UE with EPC performing downlink and uplink communication in the following two scenarios:

#### One eNB using Ideal and Real RRC

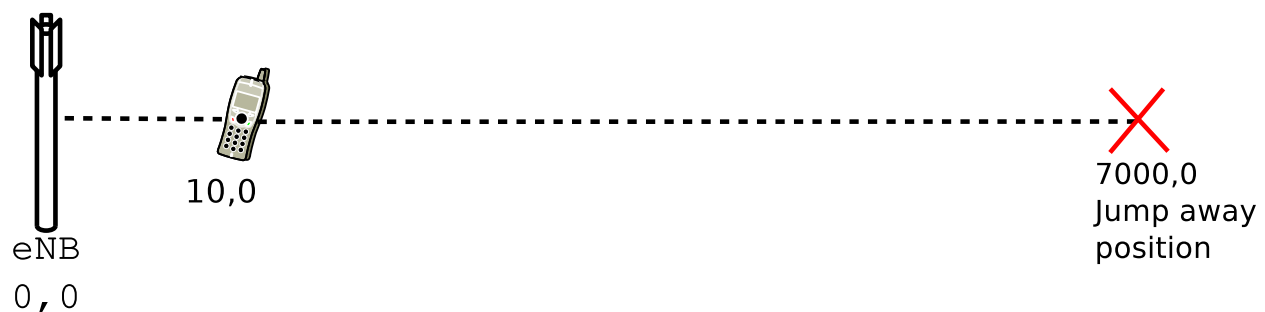

Fig. 99: RLF scenario with one eNB

In this scenario, the UE is initially placed near to the eNB, and on the following instances above conditions are verified against the expected outcome.

**At 0.3 sec:** It verifies that the UE is well connected, i.e., it is in “CONNECTED\_NORMALLY” state, and is attached to the eNB with cell id 1. It also checks for the match between the configuration of the UE and the UE context at the

eNB, e.g., IMSI, bandwidth, D/UL EARFCN, number of bearers and the bearer IDs. The miss match would result in the test suite failure.

**At 0.4 sec:** The UE jumps far away from the eNB, which causes the DL SINR at the UE to fall below -5 dB. In result, the UE PHY after monitoring the SINR for 20 consecutive frames will send a notification to the UE RRC. In this test, the N310 counter is set to 1; thus, the UE RRC will start the T310 (set to 1 sec) timer upon the first notification from the PHY layer.

**At 1 sec:** At this stage, it is expected that the T310 timer is still running, and the UE is connected to the eNB.

**Upon RLF:** It is expected that the UE RRC will start the T310 timer upon reaching the configured, i.e.,  $N310 = 1$  number of notification from the eNB. The RRC will receive no in-sync indication since the UE stays at far away position.

**Before the end of simulation:** The expected behavior is that the UE state will be in “IDLE\_CELL\_SEARCH” since there is no eNB available where it has jumped. Moreover, the deletion of the UE context from the eNB is also verified.

### Two eNBs using Ideal and Real RRC

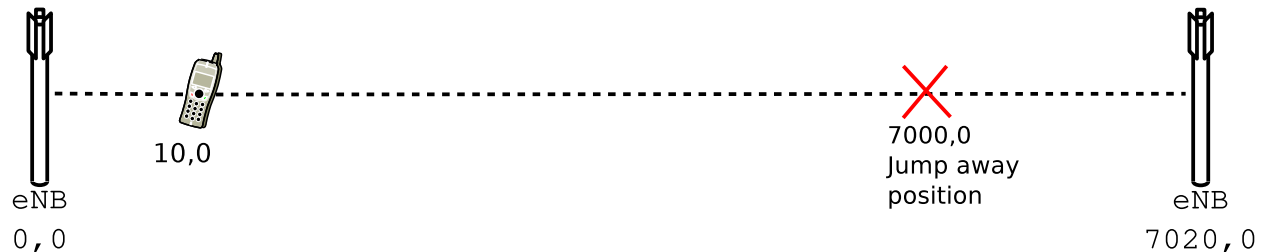

Fig. 100: RLF scenario with two eNBs

In this scenario, the only difference is the addition of a second eNB near the position where the UE jumps away. Therefore, except the outcome before the end of the simulation, all the outcomes are similar to that we expected in the first scenario.

**Before the end of simulation:** It is expected that the UE after the RLF will connect to the second eNB, i.e., it will be in “CONNECTED\_NORMALLY” state, and its context exists in the second eNB.

## 19.4 Profiling Documentation

### 19.4.1 Overview and objectives

The main objective of the profiling carried out is to assess the simulator performance on a broad set of scenarios. This evaluation provides reference values for simulation running times and memory consumption figures. It also helps to identify potential performance improvements and to check for scalability problems when increasing the number of eNodeB and UEs attached to those.

In the following sections, a detailed description of the general profiling framework employed to perform the study is introduced. It also includes details on the main performed tests and its results evaluation.

## 19.4.2 Framework description

### Simulation scripts

The simulation script used for all the E-UTRAN results showed in this documentation is located at `src/lte/examples/lte-profiling.cc`. It uses the complete PHY and MAC UE/eNodeB implementation with a simplified RLC implementation on top. This script generates a squared grid topology, placing a eNodeB at the centre of each square. UEs attached to this node are scattered randomly across the square (using a random uniform distribution along X and Y axis). If *BuildingPropagationModel* is used, the squares are replaced by rooms. To generate the UL and DL traffic, the RLC implementation always report data to be transferred.

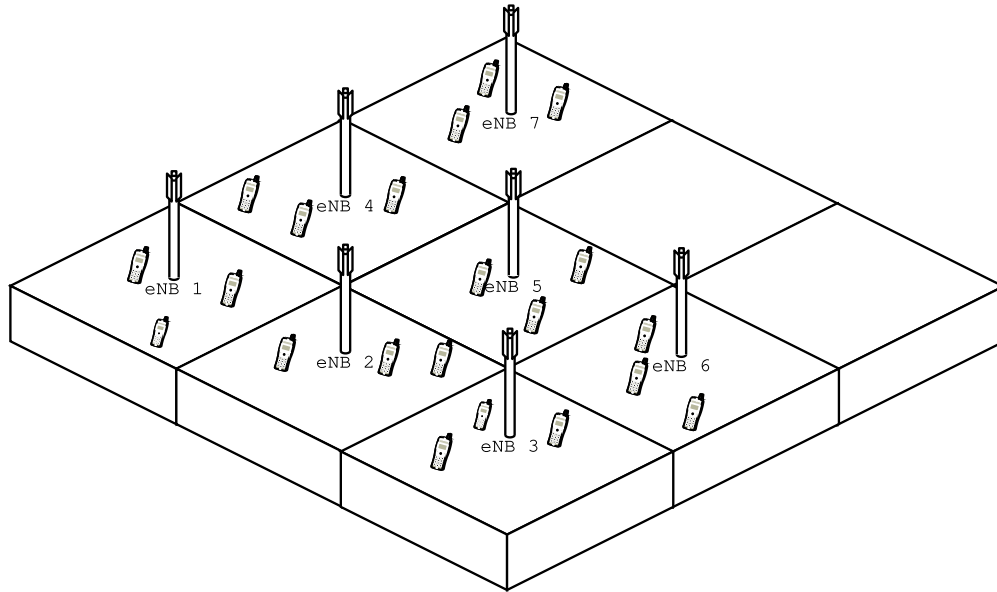

Fig. 101: E-UTRAN

For the EPC results, the script is `src/lte/examples/lte-simple-epc.cc`. It uses a complete E-UTRAN implementation (PHY+MAC+RLC/UM+PDCP) and the most relevant EPC user plane entities the PGW and SGW, including GTP-U tunneling. This script generates a given number of eNodeBs, distributed across a line and attaches a single UE to every eNodeB. It also creates an EPC network and an external host connected to it through the Internet. Each UE sends and receives data to and from the remote host. In addition, each UE is also sending data to the UE camped in the adjacent eNodeB.

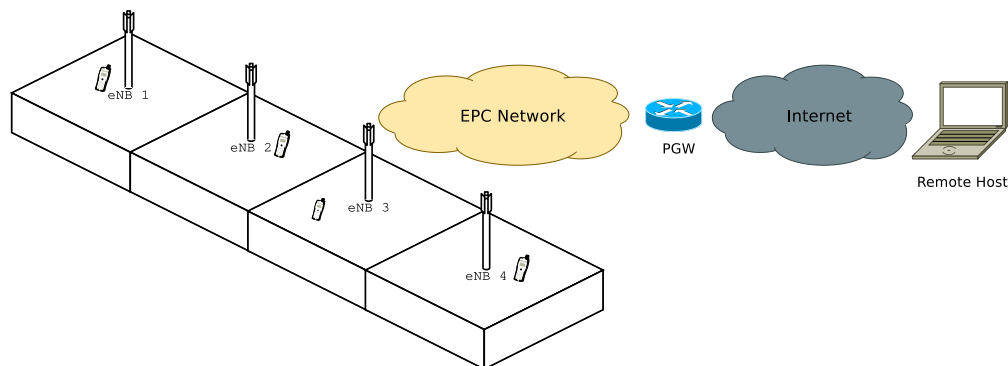

Fig. 102: Propagation Model

RLC and MAC traces are enabled for all UEs and all eNodeBs and those traces are written to disk directly. The MAC scheduler used is *round robin*.

### Simulation input parameters

The *lena-profiling* simulation script accepts the following input parameters:

- `simTime`: time to simulate (in seconds)
- `nUe`: number of UEs attached to each eNodeB
- `nEnb`: number of eNodeB composing the grid per floor
- `nFloors`: number of floors, 0 for *Friis propagation model* (no walls), 1 or greater for *Building propagation model* generating a nFloors-storey building.
- `traceDirectory`: destination directory where simulation traces will be stored

The *lena-simple-epc* script accepts those other parameters:

- `simTime`: time to simulate (in seconds)
- `numberOfNodes`: number of eNodeB + UE pairs created

### Time measurement

Running time is measured using default Linux shell command `time`. This command counts how much user time the execution of a program takes.

### Perl script

To simplify the process of running the profiling script for a wide range of values and collecting its timing data, a simple Perl script to automate the complete process is provided. It is placed in `src/lte/test/lte-test-run-time.pl` for *lena-profiling* and in `src/lte/epc-test-run-time.pl` for *lena-simple-epc*. It simply runs a batch of simulations with a range of parameters and stores the timing results in a CSV file called *lteTimes.csv* and *epcTimes.csv* respectively. The range of values each parameter sweeps can be modified editing the corresponding script.

### Requirements

**The following Perl modules are required to use the provided script, all of them available from CPAN:**

- `IO::CaptureOutput`
- `Statistics::Descriptive`

For installing the modules, simply use the following command:

```
perl -MCPAN -e 'install moduleName'
```

### Plotting results

To plot the results obtained from running the Perl scripts, two gnuplot scripts are provided, in `src/lte/test/lte-test-run-plot` and `src/lte/test/epc-test-run-plot`. Most of the plots available in this documentation can be reproduced with those, typing the commands `gnuplot < src/lte/test/lte-test-run-plot` and `gnuplot < src/lte/test/epc-test-run-plot`.

## Reference software and equipment

All timing tests had been run in a Intel Pentium IV 3.00 GHz machine with 512 Mb of RAM memory running Fedora Core 10 with a 2.6.27.41-170.2.117 kernel, storing the traces directly to the hard disk.

Also, as a reference configuration, the build has been configured static and optimized. The exact `waf` command issued is:

```
CXXFLAGS="-O3 -w" ./waf -d optimized configure --enable-static --enable-examples
--enable-modules=lte
```

## 19.4.3 Results

### E-UTRAN

The following results and figures had been obtained with LENA **changeset 2c5b0d697717**.

### Running time

This scenario, evaluates the running time for a fixed simulation time (10s) and Friis propagation mode increasing the number of UEs attached to each eNodeB and the number of planted eNodeBs in the scenario.

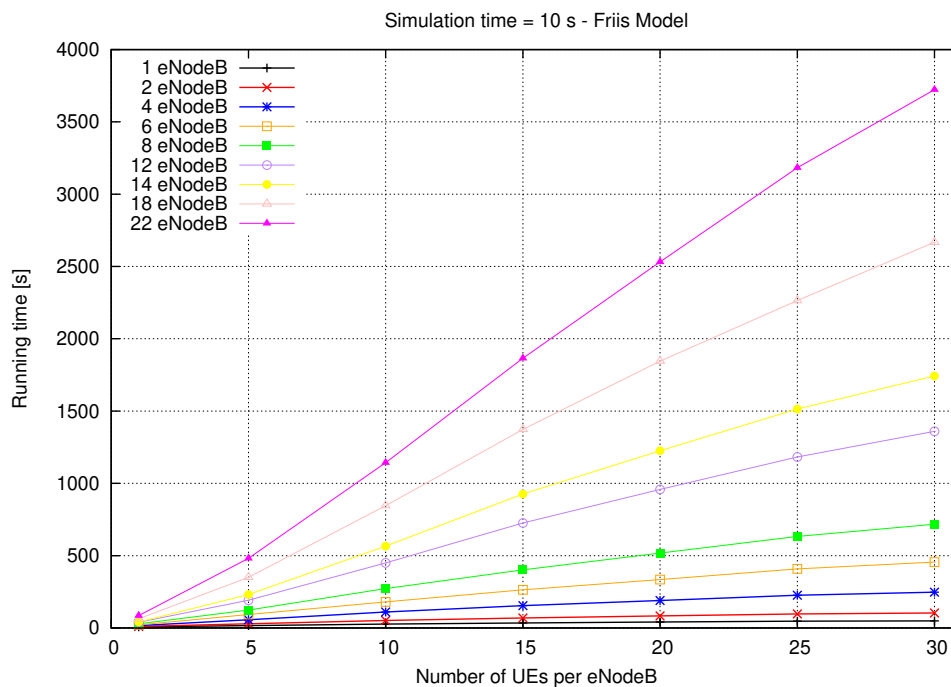

Fig. 103: Running time

The figure shows the expected behaviour, since it increases linearly respect the number of UEs per eNodeB and quadratically respect the total number of eNodeBs.

## Propagation model

The objective of this scenario is to evaluate the impact of the propagation model complexity in the overall run time figures. Therefore, the same scenario is simulated twice: once using the more simple Friis model, once with the more complex Building model. The rest of the parameters (e.g. number of eNodeB and of UE attached per eNodeB) were maintained. The timing results for both models are compared in the following figure.

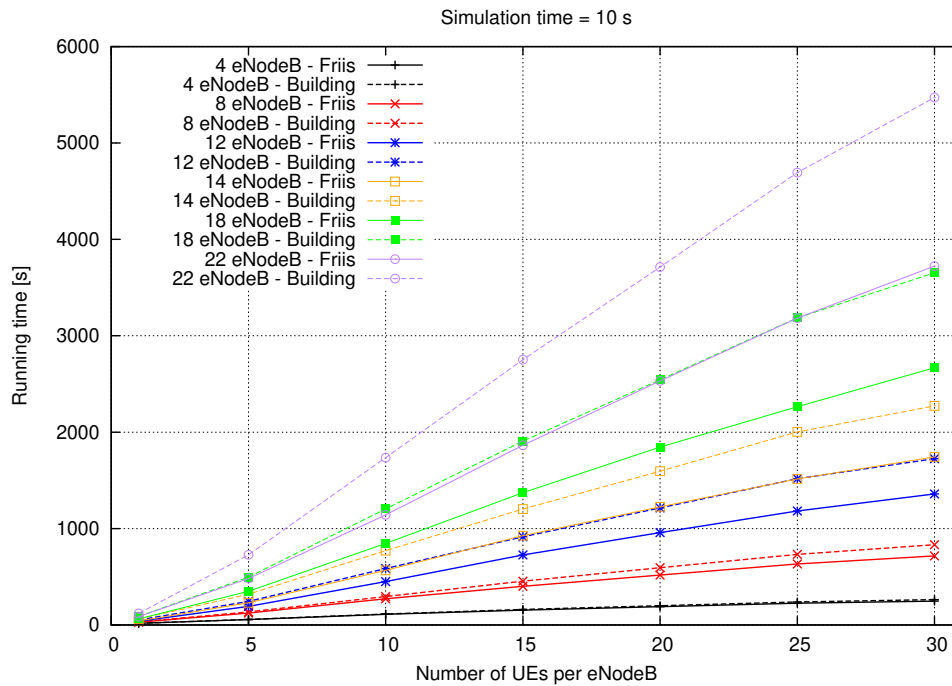

Fig. 104: Propagation Model

In this situation, results are also coherent with what is expected. The more complex the model, the higher the running time. Moreover, as the number of computed path losses increases (i.e. more UEs per eNodeB or more eNodeBs) the extra complexity of the propagation model drives the running time figures further apart.

## Simulation time

In this scenario, for a fixed set of UEs per eNodeB, different simulation times had been run. As the simulation time increases, running time should also increase linearly, i.e. for a given scenario, simulate four seconds should take twice times what it takes to simulate two seconds. The slope of this line is a function of the complexity of the scenario: the more eNodeB / UEs placed, the higher the slope of the line.

## Memory usage

Massif tool to profile memory consumption

## EPC

The following results and figures had been obtained with LENA **changeset e8b3ccdf6673**. The rationale behind the two scenarios profiled on this section is the same than for the E-UTRA part.

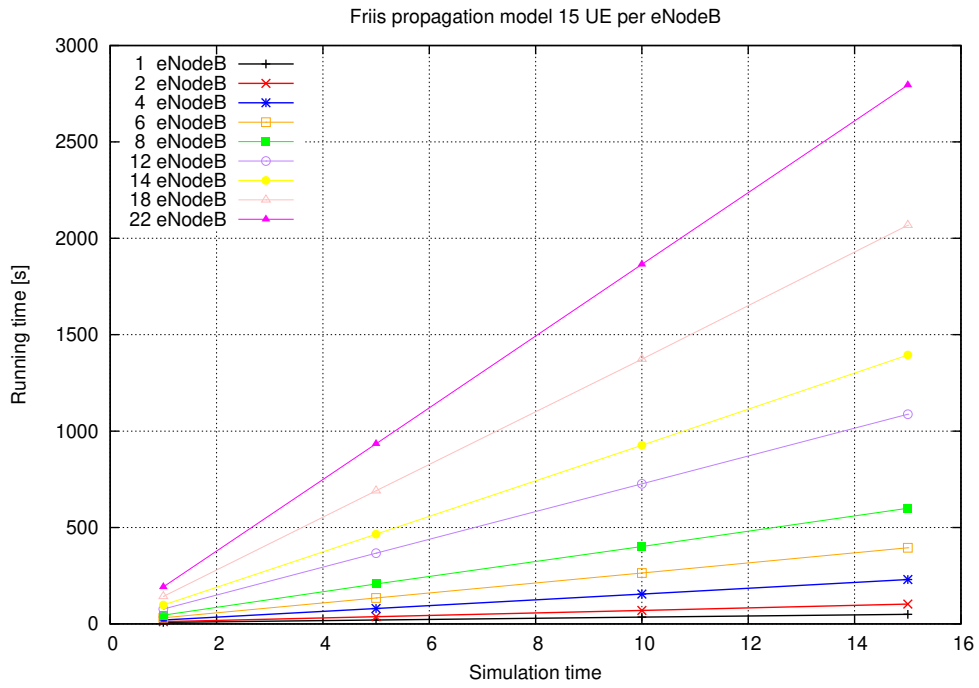

Fig. 105: Simulation time

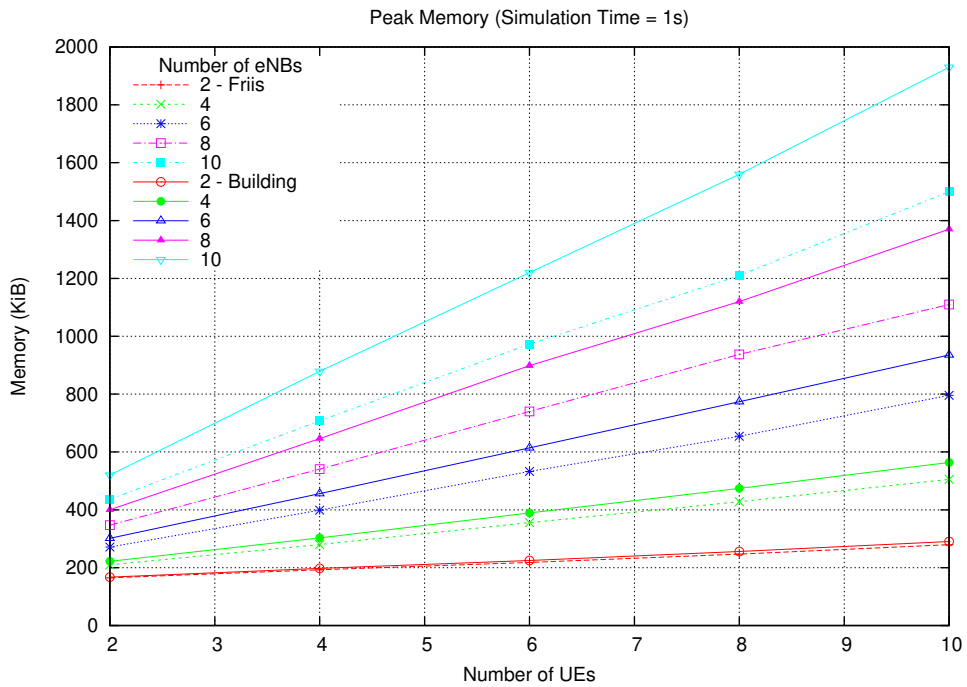

Fig. 106: Memory profile

## Running time

Running time evolution is quadratic since we increase at the same time the number of eNodeB and the number of UEs.

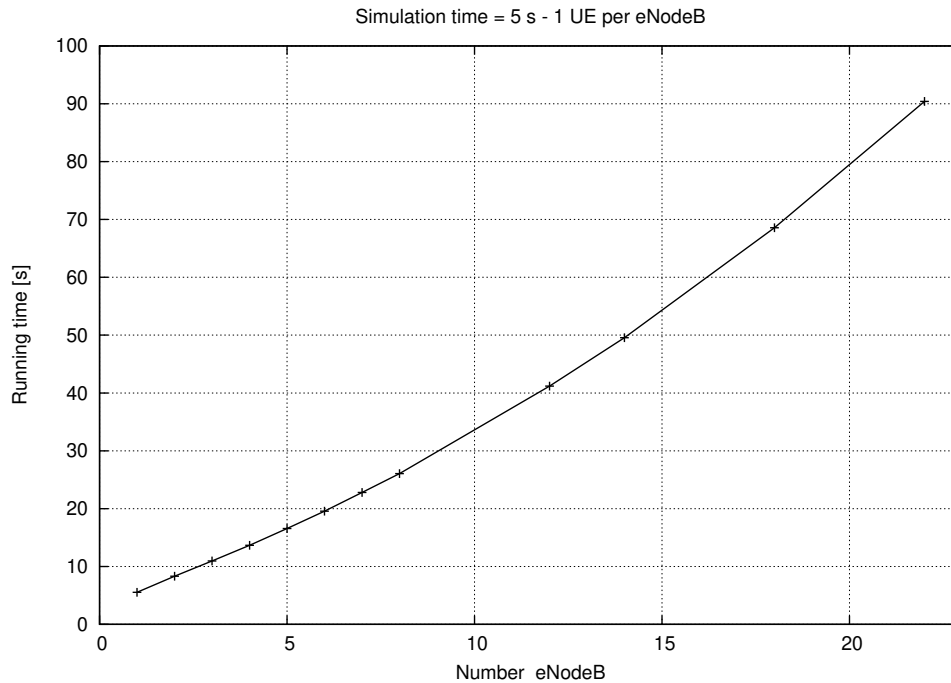

Fig. 107: Running time

To estimate the additional complexity of the upper LTE Radio Protocol Stack model and the EPC model, we compare two scenarios using the simplified E-UTRAN version (using only PHY, MAC and the simplified RLC/SM, with no EPC and no ns-3 applications) against the complete E-UTRAN + EPC (with UM RLC, PDCP, end-to-end IP networking and regular ns-3 applications). Both configuration have been tested with the same number of UEs per eNodeB, the same number of eNodeBs, and approximately the same volume of transmitted data (an exact match was not possible due to the different ways in which packets are generated in the two configurations).

From the figure, it is evident that the additional complexity of using the upper LTE stack plus the EPC model translates approximately into a doubling of the execution time of the simulations. We believe that, considered all the new features that have been added, this figure is acceptable.

## Simulation time

Finally, again the linearity of the running time as the simulation time increases gets validated through a set of experiments, as the following figure shows.

## 19.5 References



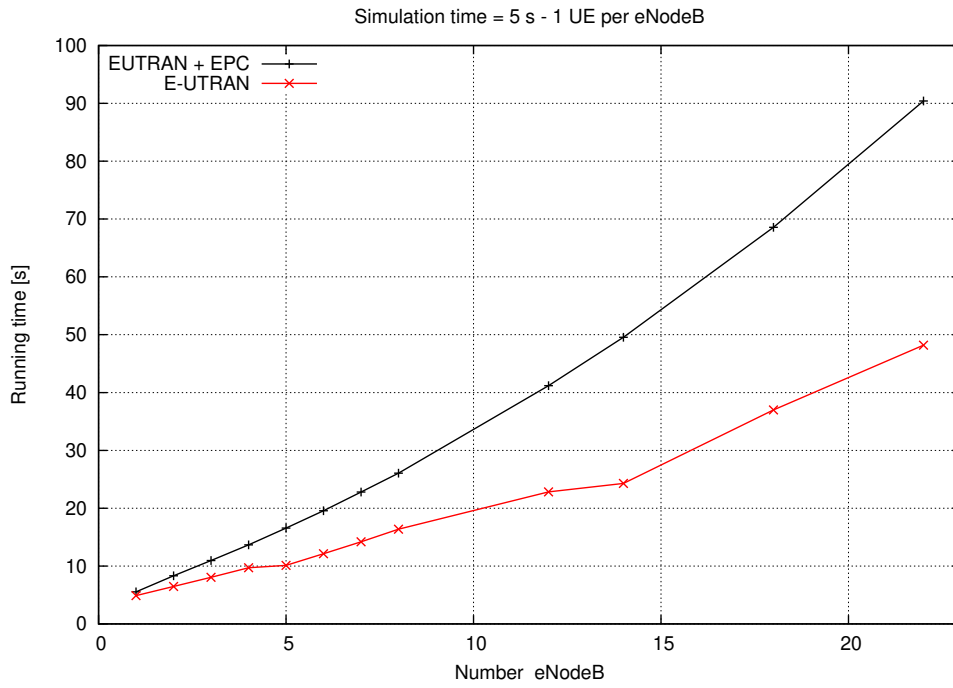

Fig. 108: EPC E-UTRAN running time

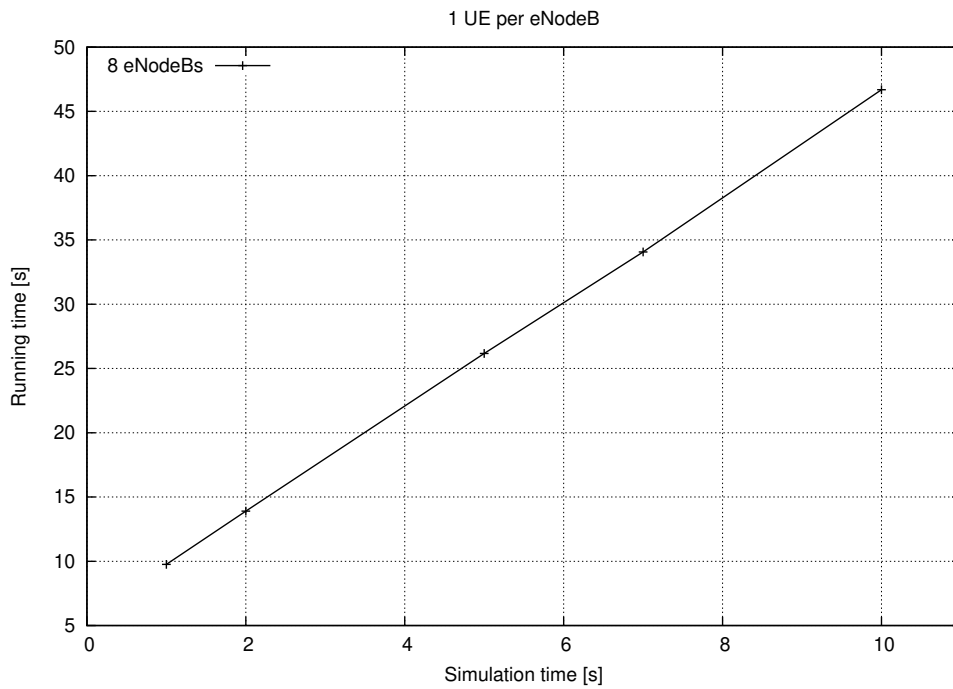

Fig. 109: Simulation time



## WI-FI MESH MODULE DOCUMENTATION

### 20.1 Design Documentation

#### 20.1.1 Overview

The *ns-3 mesh* module extends the *ns-3 wifi* module to provide mesh networking capabilities according to the IEEE 802.11s standard [ieee80211s].

The basic purpose of IEEE 802.11s is to define a mode of operation for Wi-Fi that permits frames to be forwarded over multiple radio hops transparent to higher layer protocols such as IP. To accomplish this, mesh-capable stations form a *Mesh Basic Service Set* (MBSS) by running a pair-wise peering protocol to establish forwarding associations, and by running a routing protocol to find paths through the network. A special gateway device called a *mesh gate* allows a MBSS to interconnect with a Distribution System (DS).

The basic enhancements defined by IEEE 802.11s include:

- discovery services
- peering management
- security
- beaconing and synchronization
- the Mesh Coordination Function (MCF)
- power management
- channel switching
- extended frame formats
- path selection and forwarding
- interworking (proxy mesh gateways)
- intra-mesh congestion control, and
- emergency service support.

The *ns-3* models implement only a subset of the above service extensions, focusing mainly on those items related to peering and routing/forwarding of data frames through the mesh.

The Mesh NetDevice based on 802.11s D3.0 draft standard was added in *ns-3.6* and includes the Mesh Peering Management Protocol and HWMP (routing) protocol implementations. An overview presentation by Kirill Andreev was published at the Workshop on ns-3 in 2009 [And09]. An overview paper is available at [And10].

As of ns-3.23 release, the model has been updated to the 802.11s-2012 standard [ieee80211s] with regard to packet formats, based on the contribution in [Hep15].

These changes include:

- Category codes and the categories compliant to IEEE-802.11-2012 Table 8-38—Category values.
- Information Elements (An adjustment of the element ID values was needed according to Table 8-54 of IEEE-802.11-2012).
- Mesh Peering Management element format changed according to IEEE-802.11-2012 Figure 8-370.
- Mesh Configuration element format changed according to IEEE-802.11-2012 Figure 8-363.
- PERR element format changed according to IEEE-802.11-2012 Figure 8-394.

With these changes the messages of the Peering Management Protocol and Hybrid Wireless Mesh Protocol will be transmitted compliant to IEEE802.11-2012 and the resulting pcap trace files can be analyzed by Wireshark.

The multi-interface mesh points are supported as an extension of IEEE draft version 3.0. Note that corresponding *ns-3* mesh device helper creates a single interface station by default.

### Overview of IEEE 802.11s

The implementation of the 802.11s extension consists of two main parts: the Peer Management Protocol (PMP) and Hybrid Wireless Mesh Protocol (HWMP).

The tasks of the peer management protocol are the following:

- opening links, detecting beacons, and starting peer link finite state machine, and
- closing peer links due to transmission failures or beacon loss.

If a peer link between the sender and receiver does not exist, a frame will be dropped. So, the plug-in to the peer management protocol (PMP) is the first in the list of `ns3::MeshWifiInterfaceMacPlugins` to be used.

### Peer management protocol

The peer management protocol consists of three main parts:

- the protocol itself, `ns3::dot11s::PeerManagementProtocol`, which keeps all active peer links on interfaces, handles all changes of their states and notifies the routing protocol about link failures.
- the MAC plug-in, `ns3::dot11s::PeerManagementProtocolMac`, which drops frames if there is no peer link, and peeks all needed information from management frames and information elements from beacons.
- the peer link, `ns3::dot11s::PeerLink`, which keeps finite state machine of each peer link, keeps beacon loss counter and counter of successive transmission failures.

The procedure of closing a peer link is not described in detail in the standard, so in the model the link may be closed by:

- beacon loss (see an appropriate attribute of `ns3::dot11s::PeerLink` class)
- transmission failure – when a predefined number of successive packets have failed to transmit, the link will be closed.

The peer management protocol is also responsible for beacon collision avoidance, because it keeps beacon timing elements from all neighbours. Note that the `PeerManagementProtocol` is not attached to the `MeshPointDevice` as a routing protocol, but the structure is similar: the upper tier of the protocol is `ns3::dot11s::PeerManagementProtocol` and its plug-in is `ns3::dot11s::PeerManagementProtocolMac`.

## Hybrid Wireless Mesh Protocol

HWMP is implemented in both modes, reactive and proactive, although path maintenance is not implemented (so active routes may time out and need to be rebuilt, causing packet loss). Also the model implements an ability to transmit broadcast data and management frames as unicasts (see appropriate attributes). This feature is disabled at a station when the number of neighbors of the station is more than a threshold value.

### 20.1.2 Scope and Limitations

#### Supported features

- Peering Management Protocol (PMP), including link close heuristics and beacon collision avoidance.
- Hybrid Wireless Mesh Protocol (HWMP), including proactive and reactive modes, unicast/broadcast propagation of management traffic, multi-radio extensions.
- 802.11e compatible airtime link metric.

#### Verification

- Comes with the custom Wireshark dissector.
- Linux kernel mac80211 layer compatible message formats.

#### Unsupported features

- Mesh Coordinated Channel Access (MCCA).
- Internetworking: mesh access point and mesh portal.
- Security.
- Power save.
- Path maintenance (sending PREQ proactively before a path expires)
- Though multi-radio operation is supported, no channel assignment protocol is proposed for now. (Correct channel switching is not implemented)

#### Models yet to be created

- Mesh access point (QoS + non-QoS?)
- Mesh portal (QoS + non-QoS?)

#### Open issues

A bug exists in the Wi-Fi module that manifests itself as performance degradation in large mesh networks, due to incorrect duplicate frame detection for QoS data frames (bug 2326).

Mesh does not work for 802.11n/ac stations (bug 2276).

Energy module can not be used on mesh devices (bug 2265).

IE11S\_MESH\_PEERING\_PROTOCOL\_VERSION should be removed as per standard. Protocol ID should actually be part of the Mesh Peering Management IE (bug 2600).

Node packet processing times are not modeled; some evaluation of the impact of packet processing delays is discussed in [Hep16].

## 20.2 User Documentation

### 20.2.1 Using the MeshNetDevice

## 20.3 Testing Documentation

## 20.4 References

## MPI FOR DISTRIBUTED SIMULATION

Parallel and distributed discrete event simulation allows the execution of a single simulation program on multiple processors. By splitting up the simulation into logical processes, LPs, each LP can be executed by a different processor. This simulation methodology enables very large-scale simulations by leveraging increased processing power and memory availability. In order to ensure proper execution of a distributed simulation, message passing between LPs is required. To support distributed simulation in *ns-3*, the standard Message Passing Interface (MPI) is used, along with a new distributed simulator class. Currently, dividing a simulation for distributed purposes in *ns-3* can only occur across point-to-point links.

### 21.1 Current Implementation Details

During the course of a distributed simulation, many packets must cross simulator boundaries. In other words, a packet that originated on one LP is destined for a different LP, and in order to make this transition, a message containing the packet contents must be sent to the remote LP. Upon receiving this message, the remote LP can rebuild the packet and proceed as normal. The process of sending and receiving messages between LPs is handled easily by the new MPI interface in *ns-3*.

Along with simple message passing between LPs, a distributed simulator is used on each LP to determine which events to process. It is important to process events in time-stamped order to ensure proper simulation execution. If a LP receives a message containing an event from the past, clearly this is an issue, since this event could change other events which have already been executed. To address this problem, two conservative synchronization algorithms with lookahead are used in *ns-3*. For more information on different synchronization approaches and parallel and distributed simulation in general, please refer to “Parallel and Distributed Simulation Systems” by Richard Fujimoto.

The default parallel synchronization strategy implemented in the `DistributedSimulatorImpl` class is based on a globally synchronized algorithm using an MPI collective operation to synchronize simulation time across all LPs. A second synchronization strategy based on local communication and null messages is implemented in the `NullMessageSimulatorImpl` class. For the null message strategy the global all-to-all gather is not required; LPs only need to communicate with LPs that have shared point-to-point links. The algorithm to use is controlled by which the *ns-3* global value `SimulatorImplementationType`.

The best algorithm to use is dependent on the communication and event scheduling pattern for the application. In general, null message synchronization algorithms will scale better due to local communication scaling better than a global all-to-all gather that is required by `DistributedSimulatorImpl`. There are two known cases where the global synchronization performs better. The first is when most LPs have point-to-point link with most other LPs, in other words the LPs are nearly fully connected. In this case the null message algorithm will generate more message passing traffic than the all-to-all gather. A second case where the global all-to-all gather is more efficient is when there are long periods of simulation time when no events are occurring. The all-to-all gather algorithm is able to quickly determine then next event time globally. The nearest neighbor behavior of the null message algorithm will require more communications to propagate that knowledge; each LP is only aware of neighbor next event times.

### 21.1.1 Remote point-to-point links

As described in the introduction, dividing a simulation for distributed purposes in *ns-3* currently can only occur across point-to-point links; therefore, the idea of remote point-to-point links is very important for distributed simulation in *ns-3*. When a point-to-point link is installed, connecting two nodes, the point-to-point helper checks the system id, or rank, of both nodes. The rank should be assigned during node creation for distributed simulation and is intended to signify on which LP a node belongs. If the two nodes are on the same rank, a regular point-to-point link is created. If, however, the two nodes are on different ranks, then these nodes are intended for different LPs, and a remote point-to-point link is used. If a packet is to be sent across a remote point-to-point link, MPI is used to send the message to the remote LP.

### 21.1.2 Distributing the topology

Currently, the full topology is created on each rank, regardless of the individual node system ids. Only the applications are specific to a rank. For example, consider node 1 on LP 1 and node 2 on LP 2, with a traffic generator on node 1. Both node 1 and node 2 will be created on both LP1 and LP2; however, the traffic generator will only be installed on LP1. While this is not optimal for memory efficiency, it does simplify routing, since all current routing implementations in *ns-3* will work with distributed simulation.

## 21.2 Running Distributed Simulations

### 21.2.1 Prerequisites

Ensure that MPI is installed, as well as `mpic++`. In Ubuntu repositories, these are `openmpi-bin`, `openmpi-common`, `openmpi-doc`, `libopenmpi-dev`. In Fedora, these are `openmpi` and `openmpi-devel`.

Note:

There is a conflict on some Fedora systems between `libotf` and `openmpi`. A possible “quick-fix” is to `yum remove libotf` before installing `openmpi`. This will remove conflict, but it will also remove `emacs`. Alternatively, these steps could be followed to resolve the conflict:

- 1) Rename the tiny `otfdump` which `emacs` says it needs:

```
$ mv /usr/bin/otfdump /usr/bin/otfdump.emacs-version
```

- 2) Manually resolve `openmpi` dependencies:

```
$ sudo yum install libgfortran libtorque numactl
```

- 3) Download rpm packages:

```
openmpi-1.3.1-1.fc11.i586.rpm  
openmpi-devel-1.3.1-1.fc11.i586.rpm  
openmpi-libs-1.3.1-1.fc11.i586.rpm  
openmpi-vt-1.3.1-1.fc11.i586.rpm
```

from <http://mirrors.kernel.org/fedora/releases/11/Everything/i386/os/Packages/>

- 4) Force the packages in:

```
$ sudo rpm -ivh --force \  
openmpi-1.3.1-1.fc11.i586.rpm \  
openmpi-libs-1.3.1-1.fc11.i586.rpm \  

```

(continues on next page)



(continued from previous page)

```
openmpi-devel-1.3.1-1.fc11.i586.rpm \
openmpi-vt-1.3.1-1.fc11.i586.rpm
```

Also, it may be necessary to add the openmpi bin directory to PATH in order to execute mpic++ and mpirun from the command line. Alternatively, the full path to these executables can be used. Finally, if openmpi complains about the inability to open shared libraries, such as libmpi\_cxx.so.0, it may be necessary to add the openmpi lib directory to LD\_LIBRARY\_PATH.

Here is an example of setting up PATH and LD\_LIBRARY\_PATH using a bash shell:

- For a 32-bit Linux distribution:

```
$ export PATH=$PATH:/usr/lib/openmpi/bin
$ export LD_LIBRARY_PATH=$LD_LIBRARY_PATH:/usr/lib/openmpi/lib
```

For a 64-bit Linux distribution:

```
$ export PATH=$PATH:/usr/lib64/openmpi/bin
$ export LD_LIBRARY_PATH=$LD_LIBRARY_PATH:/usr/lib64/openmpi/lib
```

These lines can be added into ~/.bash\_profile or ~/.bashrc to avoid having to retype them when a new shell is opened.

## 21.2.2 Building and Running Examples

If you already built *ns-3* without MPI enabled, you must re-build:

```
$ ./waf distclean
```

Configure *ns-3* with the `--enable-mpi` option:

```
$ ./waf -d debug configure --enable-examples --enable-tests --enable-mpi
```

Ensure that MPI is enabled by checking the optional features shown from the output of configure.

Next, build *ns-3*:

```
$ ./waf
```

After building *ns-3* with mpi enabled, the example programs are now ready to run with mpirun. Here are a few examples (from the root *ns-3* directory):

```
$ mpirun -np 2 ./waf --run simple-distributed
$ mpirun -np 4 -machinefile mpihosts ./waf --run 'nms-udp-nix --LAN=2 --CN=4 --nix=1'
```

An example using the null message synchronization algorithm:

```
$ mpirun -np 2 ./waf --run simple-distributed --nullmsg
```

The `np` switch is the number of logical processors to use. The `machinefile` switch is which machines to use. In order to use machinefile, the target file must exist (in this case `mpihosts`). This can simply contain something like:

```
localhost
localhost
localhost
...
```

Or if you have a cluster of machines, you can name them.

NOTE: Some users have experienced issues using mpirun and waf together. An alternative way to run distributed examples is shown below:

```
$ ./waf shell
$ cd build/debug
$ mpirun -np 2 src/mpi/examples/simple-distributed
```

### 21.2.3 Setting synchronization algorithm to use

The global value `SimulatorImplementationType` is used to set the synchronization algorithm to use. This value must be set before the `MpiInterface::Enable` method is invoked if the default `DistributedSimulatorImpl` is not used. Here is an example code snippet showing how to add a command line argument to control the synchronization algorithm choice::

```
cmd.AddValue ("nullmsg", "Enable the use of null-message synchronization", nullmsg);
if(nullmsg)
{
    GlobalValue::Bind ("SimulatorImplementationType",
                      StringValue ("ns3::NullMessageSimulatorImpl"));
}
else
{
    GlobalValue::Bind ("SimulatorImplementationType",
                      StringValue ("ns3::DistributedSimulatorImpl"));
}

// Enable parallel simulator with the command line arguments
MpiInterface::Enable (&argc, &argv);
```

### 21.2.4 Creating custom topologies

The example programs in `src/mpi/examples` give a good idea of how to create different topologies for distributed simulation. The main points are assigning system ids to individual nodes, creating point-to-point links where the simulation should be divided, and installing applications only on the LP associated with the target node.

Assigning system ids to nodes is simple and can be handled two different ways. First, a `NodeContainer` can be used to create the nodes and assign system ids:

```
NodeContainer nodes;
nodes.Create (5, 1); // Creates 5 nodes with system id 1.
```

Alternatively, nodes can be created individually, assigned system ids, and added to a `NodeContainer`. This is useful if a `NodeContainer` holds nodes with different system ids:

```
NodeContainer nodes;
Ptr<Node> node1 = CreateObject<Node> (0); // Create node1 with system id 0
Ptr<Node> node2 = CreateObject<Node> (1); // Create node2 with system id 1
nodes.Add (node1);
nodes.Add (node2);
```

Next, where the simulation is divided is determined by the placement of point-to-point links. If a point-to-point link is created between two nodes with different system ids, a remote point-to-point link is created, as described in *Current Implementation Details*.

Finally, installing applications only on the LP associated with the target node is very important. For example, if a traffic generator is to be placed on node 0, which is on LP0, only LP0 should install this application. This is easily accomplished by first checking the simulator system id, and ensuring that it matches the system id of the target node before installing the application.

## 21.3 Tracing During Distributed Simulations

Depending on the system id (rank) of the simulator, the information traced will be different, since traffic originating on one simulator is not seen by another simulator until it reaches nodes specific to that simulator. The easiest way to keep track of different traces is to just name the trace files or pcaps differently, based on the system id of the simulator. For example, something like this should work well, assuming all of these local variables were previously defined:

```
if (MpiInterface::GetSystemId () == 0)
{
    pointToPoint.EnablePcapAll ("distributed-rank0");
    phy.EnablePcap ("distributed-rank0", apDevices.Get (0));
    csma.EnablePcap ("distributed-rank0", csmaDevices.Get (0), true);
}
else if (MpiInterface::GetSystemId () == 1)
{
    pointToPoint.EnablePcapAll ("distributed-rank1");
    phy.EnablePcap ("distributed-rank1", apDevices.Get (0));
    csma.EnablePcap ("distributed-rank1", csmaDevices.Get (0), true);
}
```



## MOBILITY

The mobility support in *ns-3* includes:

- a set of mobility models which are used to track and maintain the *current* cartesian position and speed of an object.
- a “course change notifier” trace source which can be used to register listeners to the course changes of a mobility model
- a number of helper classes which are used to place nodes and setup mobility models (including parsers for some mobility definition formats).

### 22.1 Model Description

The source code for mobility lives in the directory `src/mobility`.

#### 22.1.1 Design

The design includes mobility models, position allocators, and helper functions.

In *ns-3*, special `MobilityModel` objects track the evolution of position with respect to a (cartesian) coordinate system. The mobility model is typically aggregated to an `ns3::Node` object and queried using `GetObject<MobilityModel> ()`. The base class `ns3::MobilityModel` is subclassed for different motion behaviors.

The initial position of objects is typically set with a `PositionAllocator`. These types of objects will lay out the position on a notional canvas. Once the simulation starts, the position allocator may no longer be used, or it may be used to pick future mobility “waypoints” for such mobility models.

Most users interact with the mobility system using mobility helper classes. The `MobilityHelper` combines a mobility model and position allocator, and can be used with a node container to install mobility capability on a set of nodes.

We first describe the coordinate system and issues surrounding multiple coordinate systems.

#### Coordinate system

There are many possible coordinate systems and possible translations between them. *ns-3* uses the Cartesian coordinate system only, at present.

The question has arisen as to how to use the mobility models (supporting Cartesian coordinates) with different coordinate systems. This is possible if the user performs conversion between the *ns-3* Cartesian and the other coordinate system. One possible library to assist is the proj4 <http://trac.osgeo.org/proj/> library for projections and reverse projections.

If we support converting between coordinate systems, we must adopt a reference. It has been suggested to use the geocentric Cartesian coordinate system as a reference. Contributions are welcome in this regard.

The question has arisen about adding a new mobility model whose motion is natively implemented in a different coordinate system (such as an orbital mobility model implemented using spherical coordinate system). We advise to create a subclass with the APIs desired (such as `Get/SetSphericalPosition`), and new position allocators, and implement the motion however desired, but must also support the conversion to cartesian (by supporting the cartesian `Get/SetPosition`).

### Coordinates

The base class for a coordinate is called `ns3::Vector`. While positions are normally described as coordinates and not vectors in the literature, it is possible to reuse the same data structure to represent position (x,y,z) and velocity (magnitude and direction from the current position). *ns-3* uses class `Vector` for both.

There are also some additional related structures used to support mobility models.

- `Rectangle`
- `Box`
- `Waypoint`

### MobilityModel

Describe base class

- `GetPosition ()`
- Position and Velocity attributes
- `GetDistanceFrom ()`
- `CourseChangeNotification`

### MobilityModel Subclasses

- `ConstantPosition`
- `ConstantVelocity`
- `ConstantAcceleration`
- `GaussMarkov`
- `Hierarchical`
- `RandomDirection2D`
- `RandomWalk2D`
- `RandomWaypoint`
- `SteadyStateRandomWaypoint`
- `Waypoint`

## PositionAllocator

Position allocators usually used only at beginning, to lay out the nodes initial position. However, some mobility models (e.g. RandomWaypoint) will use a position allocator to pick new waypoints.

- ListPositionAllocator
- GridPositionAllocator
- RandomRectanglePositionAllocator
- RandomBoxPositionAllocator
- RandomDiscPositionAllocator
- UniformDiscPositionAllocator

## Helper

A special mobility helper is provided that is mainly aimed at supporting the installation of mobility to a Node container (when using containers at the helper API level). The MobilityHelper class encapsulates a MobilityModel factory object and a PositionAllocator used for initial node layout.

## ns-2 MobilityHelper

The *ns-2* mobility format is a widely used mobility trace format. The documentation is available at: <http://www.isi.edu/nsnam/ns/doc/node172.html>

Valid trace files use the following ns2 statements:

```
$node set X_ x1
$node set Y_ y1
$node set Z_ z1
$ns at $time $node setdest x2 y2 speed
$ns at $time $node set X_ x1
$ns at $time $node set Y_ Y1
$ns at $time $node set Z_ Z1
```

In the above, the initial positions are set using the `set` statements. Also, this `set` can be specified for a future time, such as in the last three statements above.

The command `setdest` instructs the simulation to start moving the specified node towards the coordinate (x2, y2) at the specified time. Note that the node may never get to the destination, but will proceed towards the destination at the specified speed until it either reaches the destination (where it will pause), is set to a new position (via `set`), or sent on another course change (via `setdest`).

Note that in *ns-3*, movement along the Z dimension is not supported.

Some examples of external tools that can export in this format include:

- [BonnMotion](#)
  - [Installation instructions](#) and
  - [Documentation](#) for using BonnMotion with *ns-3*
- [SUMO](#)
- [TraNS](#)
- *ns-2* `setdest` utility

A special `Ns2MobilityHelper` object can be used to parse these files and convert the statements into *ns-3* mobility events. The underlying `ConstantVelocityMobilityModel` is used to model these movements.

See below for additional usage instructions on this helper.

### 22.1.2 Scope and Limitations

- only cartesian coordinates are presently supported

### 22.1.3 References

TBD

## 22.2 Usage

Most *ns-3* program authors typically interact with the mobility system only at configuration time. However, various *ns-3* objects interact with mobility objects repeatedly during runtime, such as a propagation model trying to determine the path loss between two mobile nodes.

### 22.2.1 Helper

A typical usage pattern can be found in the `third.cc` program in the tutorial.

First, the user instantiates a `MobilityHelper` object and sets some `Attributes` controlling the “position allocator” functionality.

```
MobilityHelper mobility;

mobility.SetPositionAllocator ("ns3::GridPositionAllocator",
    "MinX", DoubleValue (0.0),
    "MinY", DoubleValue (0.0),
    "DeltaX", DoubleValue (5.0),
    "DeltaY", DoubleValue (10.0),
    "GridWidth", UIntegerValue (3),
    "LayoutType", StringValue ("RowFirst"));
```

This code tells the mobility helper to use a two-dimensional grid to initially place the nodes. The first argument is an *ns-3* `TypeId` specifying the type of mobility model; the remaining attribute/value pairs configure this position allocator.

Next, the user typically sets the `MobilityModel` subclass; e.g.:

```
mobility.SetMobilityModel ("ns3::RandomWalk2dMobilityModel",
    "Bounds", RectangleValue (Rectangle (-50, 50, -50, 50)));
```

Once the helper is configured, it is typically passed a container, such as:

```
mobility.Install (wifiStaNodes);
```

A `MobilityHelper` object may be reconfigured and reused for different `NodeContainers` during the configuration of an *ns-3* scenario.



## 22.2.2 Ns2MobilityHelper

Two example programs are provided demonstrating the use of the *ns-2* mobility helper:

- `ns2-mobility-trace.cc`
- `bonnmotion-ns2-example.cc`

### ns2-mobility-trace

The `ns2-mobility-trace.cc` program is an example of loading an *ns-2* trace file that specifies the movements of two nodes over 100 seconds of simulation time. It is paired with the file `default.ns_movements`.

The program behaves as follows:

- a `Ns2MobilityHelper` object is created, with the specified trace file.
- A log file is created, using the log file name argument.
- A node container is created with the number of nodes specified in the command line. For this particular trace file, specify the value 2 for this argument.
- the `Install()` method of `Ns2MobilityHelper` to set mobility to nodes. At this moment, the file is read line by line, and the movement is scheduled in the simulator.
- A callback is configured, so each time a node changes its course a log message is printed.

The example prints out messages generated by each read line from the *ns2* movement trace file. For each line, it shows if the line is correct, or if it has errors and in this case it will be ignored.

Example usage:

```
$ ./waf --run "ns2-mobility-trace \
--traceFile=src/mobility/examples/default.ns_movements \
--nodeNum=2 \
--duration=100.0 \
--logFile=ns2-mob.log"
```

Sample log file output:

```
+0.0ns POS: x=150, y=93.986, z=0; VEL:0, y=50.4038, z=0
+0.0ns POS: x=195.418, y=150, z=0; VEL:50.1186, y=0, z=0
+104727357.0ns POS: x=200.667, y=150, z=0; VEL:50.1239, y=0, z=0
+204480076.0ns POS: x=205.667, y=150, z=0; VEL:0, y=0, z=0
```

### bonnmotion-ns2-example

The `bonnmotion-ns2-example.cc` program, which models the movement of a single mobile node for 1000 seconds of simulation time, has a few associated files:

- `bonnmotion.ns_movements` is the *ns-2*-formatted mobility trace
- `bonnmotion.params` is a `BonnMotion`-generated file with some metadata about the mobility trace
- `bonnmotion.ns_params` is another `BonnMotion`-generated file with *ns-2*-related metadata.

Neither of the latter two files is used by *ns-3*, although they are generated as part of the `BonnMotion` process to output *ns-2*-compatible traces.

The program `bonnmotion-ns2-example.cc` will output the following to stdout:

```

At 0.00 node 0: Position(329.82, 66.06, 0.00); Speed(0.53, -0.22, 0.00)
At 100.00 node 0: Position(378.38, 45.59, 0.00); Speed(0.00, 0.00, 0.00)
At 200.00 node 0: Position(304.52, 123.66, 0.00); Speed(-0.92, 0.97, 0.00)
At 300.00 node 0: Position(274.16, 131.67, 0.00); Speed(-0.53, -0.46, 0.00)
At 400.00 node 0: Position(202.11, 123.60, 0.00); Speed(-0.98, 0.35, 0.00)
At 500.00 node 0: Position(104.60, 158.95, 0.00); Speed(-0.98, 0.35, 0.00)
At 600.00 node 0: Position(31.92, 183.87, 0.00); Speed(0.76, -0.51, 0.00)
At 700.00 node 0: Position(107.99, 132.43, 0.00); Speed(0.76, -0.51, 0.00)
At 800.00 node 0: Position(184.06, 80.98, 0.00); Speed(0.76, -0.51, 0.00)
At 900.00 node 0: Position(250.08, 41.76, 0.00); Speed(0.60, -0.05, 0.00)

```

The motion of the mobile node is sampled every 100 seconds, and its position and speed are printed out. This output may be compared to the output of a similar *ns-2* program (found in the *ns-2* `tcl/ex/` directory of *ns-2*) running from the same mobility trace.

The next file is generated from *ns-2* (users will have to download and install *ns-2* and run this Tcl program to see this output). The output of the *ns-2* `bonnmotion-example.tcl` program is shown below for comparison (file `bonnmotion-example.tr`):

```

M 0.00000 0 (329.82, 66.06, 0.00), (378.38, 45.59), 0.57
M 100.00000 0 (378.38, 45.59, 0.00), (378.38, 45.59), 0.57
M 119.37150 0 (378.38, 45.59, 0.00), (286.69, 142.52), 1.33
M 200.00000 0 (304.52, 123.66, 0.00), (286.69, 142.52), 1.33
M 276.35353 0 (286.69, 142.52, 0.00), (246.32, 107.57), 0.70
M 300.00000 0 (274.16, 131.67, 0.00), (246.32, 107.57), 0.70
M 354.65589 0 (246.32, 107.57, 0.00), (27.38, 186.94), 1.04
M 400.00000 0 (202.11, 123.60, 0.00), (27.38, 186.94), 1.04
M 500.00000 0 (104.60, 158.95, 0.00), (27.38, 186.94), 1.04
M 594.03719 0 (27.38, 186.94, 0.00), (241.02, 42.45), 0.92
M 600.00000 0 (31.92, 183.87, 0.00), (241.02, 42.45), 0.92
M 700.00000 0 (107.99, 132.43, 0.00), (241.02, 42.45), 0.92
M 800.00000 0 (184.06, 80.98, 0.00), (241.02, 42.45), 0.92
M 884.77399 0 (241.02, 42.45, 0.00), (309.59, 37.22), 0.60
M 900.00000 0 (250.08, 41.76, 0.00), (309.59, 37.22), 0.60

```

The output formatting is slightly different, and the course change times are additionally plotted, but it can be seen that the position vectors are the same between the two traces at intervals of 100 seconds.

The mobility computations performed on the *ns-2* trace file are slightly different in *ns-2* and *ns-3*, and floating-point arithmetic is used, so there is a chance that the position in *ns-2* may be slightly different than the respective position when using the trace file in *ns-3*.

## 22.2.3 Use of Random Variables

A typical use case is to evaluate protocols on a mobile topology that involves some randomness in the motion or initial position allocation. To obtain random motion and positioning that is not affected by the configuration of the rest of the scenario, it is recommended to use the “AssignStreams” facility of the random number system.

Class `MobilityModel` and class `PositionAllocator` both have public API to assign streams to underlying random variables:

```

/**
 * Assign a fixed random variable stream number to the random variables
 * used by this model. Return the number of streams (possibly zero) that
 * have been assigned.
 */

```

(continues on next page)

(continued from previous page)

```

* \param stream first stream index to use
* \return the number of stream indices assigned by this model
*/
int64_t AssignStreams (int64_t stream);

```

The class `MobilityHelper` also provides this API. The typical usage pattern when using the helper is:

```

int64_t streamIndex = /*some positive integer */
MobilityHelper mobility;
... (configure mobility)
mobility.Install (wifiStaNodes);
int64_t streamsUsed = mobility.AssignStreams (wifiStaNodes, streamIndex);

```

If `AssignStreams` is called before `Install`, it will not have any effect.

## 22.2.4 Advanced Usage

A number of external tools can be used to generate traces read by the `Ns2MobilityHelper`.

### ns-2 scengen

TBD

### BonnMotion

<http://net.cs.uni-bonn.de/wg/cs/applications/bonnmotion/>

### SUMO

[http://sourceforge.net/apps/mediawiki/sumo/index.php?title=Main\\_Page](http://sourceforge.net/apps/mediawiki/sumo/index.php?title=Main_Page)

### TraNS

<http://trans.epfl.ch/>

## 22.2.5 Examples

- `main-random-topology.cc`
- `main-random-walk.cc`
- `main-grid-topology.cc`
- `ns2-mobility-trace.cc`
- `ns2-bonnmotion.cc`

## 22.3 Validation

TBD



## NETWORK MODULE

### 23.1 Packets

The design of the Packet framework of *ns* was heavily guided by a few important use-cases:

- avoid changing the core of the simulator to introduce new types of packet headers or trailers
- maximize the ease of integration with real-world code and systems
- make it easy to support fragmentation, defragmentation, and, concatenation which are important, especially in wireless systems.
- make memory management of this object efficient
- allow actual application data or dummy application bytes for emulated applications

Each network packet contains a byte buffer, a set of byte tags, a set of packet tags, and metadata.

The byte buffer stores the serialized content of the headers and trailers added to a packet. The serialized representation of these headers is expected to match that of real network packets bit for bit (although nothing forces you to do this) which means that the content of a packet buffer is expected to be that of a real packet.

Fragmentation and defragmentation are quite natural to implement within this context: since we have a buffer of real bytes, we can split it in multiple fragments and re-assemble these fragments. We expect that this choice will make it really easy to wrap our Packet data structure within Linux-style *skb* or BSD-style *mbuf* to integrate real-world kernel code in the simulator. We also expect that performing a real-time plug of the simulator to a real-world network will be easy.

One problem that this design choice raises is that it is difficult to pretty-print the packet headers without context. The packet metadata describes the type of the headers and trailers which were serialized in the byte buffer. The maintenance of metadata is optional and disabled by default. To enable it, you must call `Packet::EnablePrinting()` and this will allow you to get non-empty output from `Packet::Print` and `Packet::Print`.

Also, developers often want to store data in packet objects that is not found in the real packets (such as timestamps or flow-ids). The Packet class deals with this requirement by storing a set of tags (class `Tag`). We have found two classes of use cases for these tags, which leads to two different types of tags. So-called ‘byte’ tags are used to tag a subset of the bytes in the packet byte buffer while ‘packet’ tags are used to tag the packet itself. The main difference between these two kinds of tags is what happens when packets are copied, fragmented, and reassembled: ‘byte’ tags follow bytes while ‘packet’ tags follow packets. Another important difference between these two kinds of tags is that byte tags cannot be removed and are expected to be written once, and read many times, while packet tags are expected to be written once, read many times, and removed exactly once. An example of a ‘byte’ tag is a `FlowIdTag` which contains a flow id and is set by the application generating traffic. An example of a ‘packet’ tag is a cross-layer QoS class id set by an application and processed by a lower-level MAC layer.

Memory management of Packet objects is entirely automatic and extremely efficient: memory for the application-level payload can be modeled by a virtual buffer of zero-filled bytes for which memory is never allocated unless explicitly requested by the user or unless the packet is fragmented or serialized out to a real network device. Furthermore,

copying, adding, and, removing headers or trailers to a packet has been optimized to be virtually free through a technique known as Copy On Write.

Packets (messages) are fundamental objects in the simulator and their design is important from a performance and resource management perspective. There are various ways to design the simulation packet, and tradeoffs among the different approaches. In particular, there is a tension between ease-of-use, performance, and safe interface design.

### 23.1.1 Packet design overview

Unlike *ns-2*, in which Packet objects contain a buffer of C++ structures corresponding to protocol headers, each network packet in *ns-3* contains a byte Buffer, a list of byte Tags, a list of packet Tags, and a PacketMetadata object:

- The byte buffer stores the serialized content of the chunks added to a packet. The serialized representation of these chunks is expected to match that of real network packets bit for bit (although nothing forces you to do this) which means that the content of a packet buffer is expected to be that of a real packet. Packets can also be created with an arbitrary zero-filled payload for which no real memory is allocated.
- Each list of tags stores an arbitrarily large set of arbitrary user-provided data structures in the packet. Each Tag is uniquely identified by its type; only one instance of each type of data structure is allowed in a list of tags. These tags typically contain per-packet cross-layer information or flow identifiers (i.e., things that you wouldn't find in the bits on the wire).

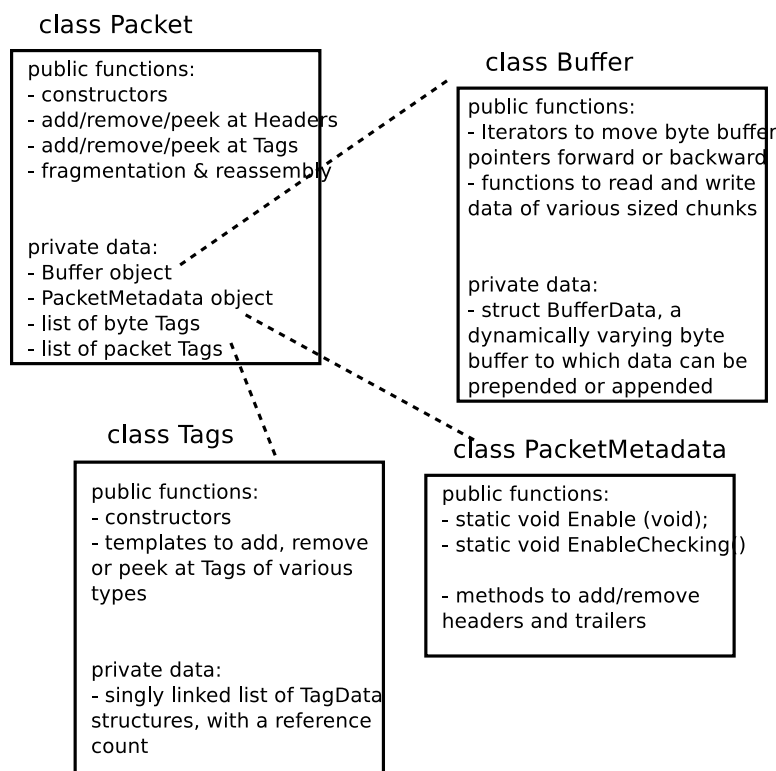

Fig. 1: Implementation overview of Packet class.

Figure *Implementation overview of Packet class* is a high-level overview of the Packet implementation; more detail on the byte Buffer implementation is provided later in Figure *Implementation overview of a packet's byte Buffer*. In *ns-3*, the Packet byte buffer is analogous to a Linux skbuff or BSD mbuf; it is a serialized representation of the actual data in the packet. The tag lists are containers for extra items useful for simulation convenience; if a Packet is converted to an emulated packet and put over an actual network, the tags are stripped off and the byte buffer is copied directly into a real packet.

Packets are reference counted objects. They are handled with smart pointer (Ptr) objects like many of the objects in the ns-3 system. One small difference you will see is that class Packet does not inherit from class Object or class RefCountBase, and implements the Ref() and Unref() methods directly. This was designed to avoid the overhead of a vtable in class Packet.

The Packet class is designed to be copied cheaply; the overall design is based on Copy on Write (COW). When there are multiple references to a packet object, and there is an operation on one of them, only so-called “dirty” operations will trigger a deep copy of the packet:

- ns3::Packet::AddHeader()
- ns3::Packet::AddTrailer()
- both versions of ns3::Packet::AddAtEnd()
- Packet::RemovePacketTag()

The fundamental classes for adding to and removing from the byte buffer are class Header and class Trailer. Headers are more common but the below discussion also largely applies to protocols using trailers. Every protocol header that needs to be inserted and removed from a Packet instance should derive from the abstract Header base class and implement the private pure virtual methods listed below:

- ns3::Header::SerializeTo()
- ns3::Header::DeserializeFrom()
- ns3::Header::GetSerializedSize()
- ns3::Header::PrintTo()

Basically, the first three functions are used to serialize and deserialize protocol control information to/from a Buffer. For example, one may define class TCPHeader : public Header. The TCPHeader object will typically consist of some private data (like a sequence number) and public interface access functions (such as checking the bounds of an input). But the underlying representation of the TCPHeader in a Packet Buffer is 20 serialized bytes (plus TCP options). The TCPHeader::SerializeTo() function would therefore be designed to write these 20 bytes properly into the packet, in network byte order. The last function is used to define how the Header object prints itself onto an output stream.

Similarly, user-defined Tags can be appended to the packet. Unlike Headers, Tags are not serialized into a contiguous buffer but are stored in lists. Tags can be flexibly defined to be any type, but there can only be one instance of any particular object type in the Tags buffer at any time.

## 23.1.2 Using the packet interface

This section describes how to create and use the ns3::Packet object.

### Creating a new packet

The following command will create a new packet with a new unique Id.:

```
Ptr<Packet> pkt = Create<Packet> ();
```

What is the Uid (unique Id)? It is an internal id that the system uses to identify packets. It can be fetched via the following method:

```
uint32_t uid = pkt->GetUid ();
```

But please note the following. This uid is an internal uid and cannot be counted on to provide an accurate counter of how many “simulated packets” of a particular protocol are in the system. It is not trivial to make this uid into such a counter, because of questions such as what should the uid be when the packet is sent over broadcast media, or when fragmentation occurs. If a user wants to trace actual packet counts, he or she should look at e.g. the IP ID field or transport sequence numbers, or other packet or frame counters at other protocol layers.

We mentioned above that it is possible to create packets with zero-filled payloads that do not actually require a memory allocation (i.e., the packet may behave, when delays such as serialization or transmission delays are computed, to have a certain number of payload bytes, but the bytes will only be allocated on-demand when needed). The command to do this is, when the packet is created:

```
Ptr<Packet> pkt = Create<Packet> (N);
```

where N is a positive integer.

The packet now has a size of N bytes, which can be verified by the `GetSize()` method:

```
/**
 * \returns the size in bytes of the packet (including the zero-filled
 *         initial payload)
 */
uint32_t GetSize (void) const;
```

You can also initialize a packet with a character buffer. The input data is copied and the input buffer is untouched. The constructor applied is:

```
Packet (uint8_t const *buffer, uint32_t size);
```

Here is an example:

```
Ptr<Packet> pkt1 = Create<Packet> (reinterpret_cast<const uint8_t*> ("hello"), 5);
```

Packets are freed when there are no more references to them, as with all *ns-3* objects referenced by the `Ptr` class.

### Adding and removing Buffer data

After the initial packet creation (which may possibly create some fake initial bytes of payload), all subsequent buffer data is added by adding objects of class `Header` or class `Trailer`. Note that, even if you are in the application layer, handling packets, and want to write application data, you write it as an `ns3::Header` or `ns3::Trailer`. If you add a `Header`, it is prepended to the packet, and if you add a `Trailer`, it is added to the end of the packet. If you have no data in the packet, then it makes no difference whether you add a `Header` or `Trailer`. Since the APIs and classes for header and trailer are pretty much identical, we’ll just look at class `Header` here.

The first step is to create a new header class. All new `Header` classes must inherit from class `Header`, and implement the following methods:

- `Serialize ()`
- `Deserialize ()`
- `GetSerializedSize ()`
- `Print ()`

To see a simple example of how these are done, look at the `UdpHeader` class headers `src/internet/model/udp-header.cc`. There are many other examples within the source code.

Once you have a header (or you have a preexisting header), the following `Packet` API can be used to add or remove such headers.:



```

/**
 * Add header to this packet. This method invokes the
 * Header::GetSerializedSize and Header::Serialize
 * methods to reserve space in the buffer and request the
 * header to serialize itself in the packet buffer.
 *
 * \param header a reference to the header to add to this packet.
 */
void AddHeader (const Header &header);
/**
 * Deserialize and remove the header from the internal buffer.
 *
 * This method invokes Header::Deserialize (begin) and should be used for
 * fixed-length headers.
 *
 * \param header a reference to the header to remove from the internal buffer.
 * \returns the number of bytes removed from the packet.
 */
uint32_t RemoveHeader (Header &header);
/**
 * Deserialize but does not remove the header from the internal buffer.
 * This method invokes Header::Deserialize.
 *
 * \param header a reference to the header to read from the internal buffer.
 * \returns the number of bytes read from the packet.
 */
uint32_t PeekHeader (Header &header) const;

```

For instance, here are the typical operations to add and remove a UDP header.:

```

// add header
Ptr<Packet> packet = Create<Packet> ();
UdpHeader udpHeader;
// Fill out udpHeader fields appropriately
packet->AddHeader (udpHeader);
...
// remove header
UdpHeader udpHeader;
packet->RemoveHeader (udpHeader);
// Read udpHeader fields as needed

```

If the header is variable-length, then another variant of RemoveHeader() is needed:

```

/**
 * \brief Deserialize and remove the header from the internal buffer.
 *
 * This method invokes Header::Deserialize (begin, end) and should be
 * used for variable-length headers (where the size is determined somehow
 * by the caller).
 *
 * \param header a reference to the header to remove from the internal buffer.
 * \param size number of bytes to deserialize
 * \returns the number of bytes removed from the packet.
 */
uint32_t RemoveHeader (Header &header, uint32_t size);

```

In this case, the caller must figure out and provide the right ‘size’ as an argument (the Deserialization routine may not know when to stop). An example of this type of header would be a series of Type-Length-Value (TLV) information

elements, where the ending point of the series of TLVs can be deduced from the packet length.

## Adding and removing Tags

There is a single base class of Tag that all packet tags must derive from. They are used in two different tag lists in the packet; the lists have different semantics and different expected use cases.

As the names imply, ByteTags follow bytes and PacketTags follow packets. What this means is that when operations are done on packets, such as fragmentation, concatenation, and appending or removing headers, the byte tags keep track of which packet bytes they cover. For instance, if a user creates a TCP segment, and applies a ByteTag to the segment, each byte of the TCP segment will be tagged. However, if the next layer down inserts an IPv4 header, this ByteTag will not cover those bytes. The converse is true for the PacketTag; it covers a packet despite the operations on it.

Each tag type must subclass `ns3::Tag`, and only one instance of each Tag type may be in each tag list. Here are a few differences in the behavior of packet tags and byte tags.

- **Fragmentation:** As mentioned above, when a packet is fragmented, each packet fragment (which is a new packet) will get a copy of all packet tags, and byte tags will follow the new packet boundaries (i.e. if the fragmented packets fragment across a buffer region covered by the byte tag, both packet fragments will still have the appropriate buffer regions byte tagged).
- **Concatenation:** When packets are combined, two different buffer regions will become one. For byte tags, the byte tags simply follow the respective buffer regions. For packet tags, only the tags on the first packet survive the merge.
- **Finding and Printing:** Both classes allow you to iterate over all of the tags and print them.
- **Removal:** Users can add and remove the same packet tag multiple times on a single packet (`AddPacketTag ()` and `RemovePacketTag ()`). The packet However, once a byte tag is added, it can only be removed by stripping all byte tags from the packet. Removing one of possibly multiple byte tags is not supported by the current API.

If a user wants to take an existing packet object and reuse it as a new packet, he or she should remove all byte tags and packet tags before doing so. An example is the `UdpEchoServer` class, which takes the received packet and “turns it around” to send back to the echo client.

The Packet API for byte tags is given below.:

```
/**
 * \param tag the new tag to add to this packet
 *
 * Tag each byte included in this packet with the
 * new tag.
 *
 * Note that adding a tag is a const operation which is pretty
 * un-intuitive. The rationale is that the content and behavior of
 * a packet is not changed when a tag is added to a packet: any
 * code which was not aware of the new tag is going to work just
 * the same if the new tag is added. The real reason why adding a
 * tag was made a const operation is to allow a trace sink which gets
 * a packet to tag the packet, even if the packet is const (and most
 * trace sources should use const packets because it would be
 * totally evil to allow a trace sink to modify the content of a
 * packet).
 */
void AddByteTag (const Tag &tag) const;
/**
 * \returns an iterator over the set of byte tags included in this packet.
```

(continues on next page)

(continued from previous page)

```

*/
ByteTagIterator GetByteTagIterator (void) const;
/**
 * \param tag the tag to search in this packet
 * \returns true if the requested tag type was found, false otherwise.
 *
 * If the requested tag type is found, it is copied in the user's
 * provided tag instance.
 */
bool FindFirstMatchingByteTag (Tag &tag) const;

/**
 * Remove all the tags stored in this packet.
 */
void RemoveAllByteTags (void);

/**
 * \param os output stream in which the data should be printed.
 *
 * Iterate over the tags present in this packet, and
 * invoke the Print method of each tag stored in the packet.
 */
void PrintByteTags (std::ostream &os) const;

```

The Packet API for packet tags is given below.:

```

/**
 * \param tag the tag to store in this packet
 *
 * Add a tag to this packet. This method calls the
 * Tag::GetSerializedSize and, then, Tag::Serialize.
 *
 * Note that this method is const, that is, it does not
 * modify the state of this packet, which is fairly
 * un-intuitive.
 */
void AddPacketTag (const Tag &tag) const;
/**
 * \param tag the tag to remove from this packet
 * \returns true if the requested tag is found, false
 * otherwise.
 *
 * Remove a tag from this packet. This method calls
 * Tag::Deserialize if the tag is found.
 */
bool RemovePacketTag (Tag &tag);
/**
 * \param tag the tag to search in this packet
 * \returns true if the requested tag is found, false
 * otherwise.
 *
 * Search a matching tag and call Tag::Deserialize if it is found.
 */
bool PeekPacketTag (Tag &tag) const;
/**
 * Remove all packet tags.
 */

```

(continues on next page)

(continued from previous page)

```

void RemoveAllPacketTags (void);

/**
 * \param os the stream in which we want to print data.
 *
 * Print the list of 'packet' tags.
 *
 * \sa Packet::AddPacketTag, Packet::RemovePacketTag, Packet::PeekPacketTag,
 * Packet::RemoveAllPacketTags
 */
void PrintPacketTags (std::ostream &os) const;

/**
 * \returns an object which can be used to iterate over the list of
 * packet tags.
 */
PacketTagIterator GetPacketTagIterator (void) const;

```

Here is a simple example illustrating the use of tags from the code in `src/internet/model/udp-socket-impl.cc`:

```

Ptr<Packet> p; // pointer to a pre-existing packet
SocketIpTtlTag tag;
tag.SetTtl (m_ipMulticastTtl); // Convey the TTL from UDP layer to IP layer
p->AddPacketTag (tag);

```

This tag is read at the IP layer, then stripped (`src/internet/model/ipv4-l3-protocol.cc`):

```

uint8_t ttl = m_defaultTtl;
SocketIpTtlTag tag;
bool found = packet->RemovePacketTag (tag);
if (found)
{
    ttl = tag.GetTtl ();
}

```

## Fragmentation and concatenation

Packets may be fragmented or merged together. For example, to fragment a packet `p` of 90 bytes into two packets, one containing the first 10 bytes and the other containing the remaining 80, one may call the following code:

```

Ptr<Packet> frag0 = p->CreateFragment (0, 10);
Ptr<Packet> frag1 = p->CreateFragment (10, 90);

```

As discussed above, the packet tags from `p` will follow to both packet fragments, and the byte tags will follow the byte ranges as needed.

Now, to put them back together:

```

frag0->AddAtEnd (frag1);

```

Now `frag0` should be equivalent to the original packet `p`. If, however, there were operations on the fragments before being reassembled (such as tag operations or header operations), the new packet will not be the same.

## Enabling metadata

We mentioned above that packets, being on-the-wire representations of byte buffers, present a problem to print out in a structured way unless the printing function has access to the context of the header. For instance, consider a tcpdump-like printer that wants to pretty-print the contents of a packet.

To enable this usage, packets may have metadata enabled (disabled by default for performance reasons). This class is used by the Packet class to record every operation performed on the packet's buffer, and provides an implementation of `Packet::Print ()` method that uses the metadata to analyze the content of the packet's buffer.

The metadata is also used to perform extensive sanity checks at runtime when performing operations on a Packet. For example, this metadata is used to verify that when you remove a header from a packet, this same header was actually present at the front of the packet. These errors will be detected and will abort the program.

To enable this operation, users will typically insert one or both of these statements at the beginning of their programs:

```
Packet::EnablePrinting ();
Packet::EnableChecking ();
```

### 23.1.3 Sample programs

See `src/network/examples/main-packet-header.cc` and `src/network/examples/main-packet-tag.cc`.

### 23.1.4 Implementation details

#### Private member variables

A Packet object's interface provides access to some private data:

```
Buffer m_buffer;
ByteTagList m_byteTagList;
PacketTagList m_packetTagList;
PacketMetadata m_metadata;
mutable uint32_t m_refCount;
static uint32_t m_globalUid;
```

Each Packet has a Buffer and two Tags lists, a PacketMetadata object, and a ref count. A static member variable keeps track of the UIDs allocated. The actual uid of the packet is stored in the PacketMetadata.

Note: that real network packets do not have a UID; the UID is therefore an instance of data that normally would be stored as a Tag in the packet. However, it was felt that a UID is a special case that is so often used in simulations that it would be more convenient to store it in a member variable.

#### Buffer implementation

Class Buffer represents a buffer of bytes. Its size is automatically adjusted to hold any data prepended or appended by the user. Its implementation is optimized to ensure that the number of buffer resizes is minimized, by creating new Buffers of the maximum size ever used. The correct maximum size is learned at runtime during use by recording the maximum size of each packet.

Authors of new Header or Trailer classes need to know the public API of the Buffer class. (add summary here)

The byte buffer is implemented as follows:

```
struct BufferData {
    uint32_t m_count;
    uint32_t m_size;
    uint32_t m_initialStart;
    uint32_t m_dirtyStart;
    uint32_t m_dirtySize;
    uint8_t m_data[1];
};
struct BufferData *m_data;
uint32_t m_zeroAreaSize;
uint32_t m_start;
uint32_t m_size;
```

- BufferData::m\_count: reference count for BufferData structure
- BufferData::m\_size: size of data buffer stored in BufferData structure
- BufferData::m\_initialStart: offset from start of data buffer where data was first inserted
- BufferData::m\_dirtyStart: offset from start of buffer where every Buffer which holds a reference to this BufferData instance have written data so far
- BufferData::m\_dirtySize: size of area where data has been written so far
- BufferData::m\_data: pointer to data buffer
- Buffer::m\_zeroAreaSize: size of zero area which extends before m\_initialStart
- Buffer::m\_start: offset from start of buffer to area used by this buffer
- Buffer::m\_size: size of area used by this Buffer in its BufferData structure

This data structure is summarized in Figure *Implementation overview of a packet's byte Buffer*. Each Buffer holds a pointer to an instance of a BufferData. Most Buffers should be able to share the same underlying BufferData and thus simply increase the BufferData's reference count. If they have to change the content of a BufferData inside the Dirty Area, and if the reference count is not one, they first create a copy of the BufferData and then complete their state-changing operation.

## Tags implementation

(XXX revise me)

Tags are implemented by a single pointer which points to the start of a linked list of TagData data structures. Each TagData structure points to the next TagData in the list (its next pointer contains zero to indicate the end of the linked list). Each TagData contains an integer unique id which identifies the type of the tag stored in the TagData.:

```
struct TagData {
    struct TagData *m_next;
    uint32_t m_id;
    uint32_t m_count;
    uint8_t m_data[Tags::SIZE];
};
class Tags {
    struct TagData *m_next;
};
```

Adding a tag is a matter of inserting a new TagData at the head of the linked list. Looking at a tag requires you to find the relevant TagData in the linked list and copy its data into the user data structure. Removing a tag and updating the content of a tag requires a deep copy of the linked list before performing this operation. On the other hand, copying a Packet and its tags is a matter of copying the TagData head pointer and incrementing its reference count.

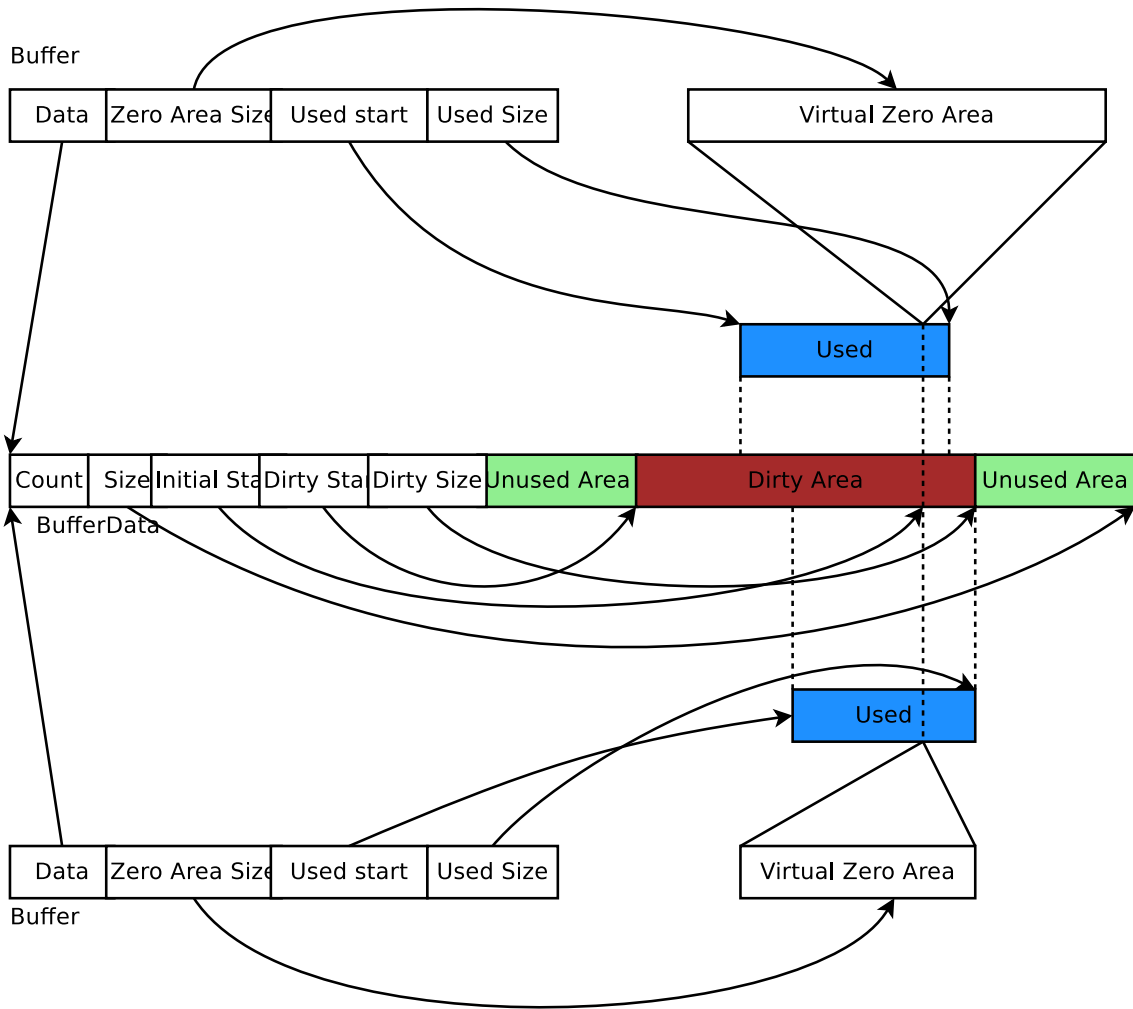

Fig. 2: Implementation overview of a packet's byte Buffer.

Tags are found by the unique mapping between the Tag type and its underlying id. This is why at most one instance of any Tag can be stored in a packet. The mapping between Tag type and underlying id is performed by a registration as follows:

```
/* A sample Tag implementation
 */
struct MyTag {
    uint16_t m_streamId;
};
```

## Memory management

*Describe dataless vs. data-full packets.*

## Copy-on-write semantics

The current implementation of the byte buffers and tag list is based on COW (Copy On Write). An introduction to COW can be found in Scott Meyer's "More Effective C++", items 17 and 29). This design feature and aspects of the public interface borrows from the packet design of the Georgia Tech Network Simulator. This implementation of COW uses a customized reference counting smart pointer class.

What COW means is that copying packets without modifying them is very cheap (in terms of CPU and memory usage) and modifying them can be also very cheap. What is key for proper COW implementations is being able to detect when a given modification of the state of a packet triggers a full copy of the data prior to the modification: COW systems need to detect when an operation is "dirty" and must therefore invoke a true copy.

Dirty operations:

- ns3::Packet::AddHeader
- ns3::Packet::AddTrailer
- both versions of ns3::Packet::AddAtEnd
- ns3::Packet::RemovePacketTag

Non-dirty operations:

- ns3::Packet::AddPacketTag
- ns3::Packet::PeekPacketTag
- ns3::Packet::RemoveAllPacketTags
- ns3::Packet::AddByteTag
- ns3::Packet::FindFirstMatchingByteTag
- ns3::Packet::RemoveAllByteTags
- ns3::Packet::RemoveHeader
- ns3::Packet::RemoveTrailer
- ns3::Packet::CreateFragment
- ns3::Packet::RemoveAtStart
- ns3::Packet::RemoveAtEnd
- ns3::Packet::CopyData



Dirty operations will always be slower than non-dirty operations, sometimes by several orders of magnitude. However, even the dirty operations have been optimized for common use-cases which means that most of the time, these operations will not trigger data copies and will thus be still very fast.

## 23.2 Error Model

This section documents a few error model objects, typically associated with NetDevice models, that are maintained as part of the `network` module:

- RateErrorModel
- ListErrorModel
- ReceiveListErrorModel
- BurstErrorModel

Error models are used to indicate that a packet should be considered to be errored, according to the underlying (possibly stochastic or empirical) error model.

### 23.2.1 Model Description

The source code for error models live in the directory `src/packet/utils`.

Two types of error models are generally provided. The first are stochastic models. In this case, packets are errored according to underlying random variable distributions. An example of this is the `RateErrorModel`. The other type of model is a deterministic or empirical model, in which packets are errored according to a particular prescribed pattern. An example is the `ListErrorModel` that allows users to specify the list of packets to be errored, by listing the specific packet UIDs.

The `ns3::RateErrorModel` errors packets according to an underlying random variable distribution, which is by default a `UniformRandomVariable` distributed between 0.0 and 1.0. The error rate and error units (bit, byte, or packet) are set by the user. For instance, by setting `ErrorRate` to 0.1 and `ErrorUnit` to “Packet”, in the long run, around 10% of the packets will be lost.

#### Design

Error models are *ns-3* objects and can be created using the typical pattern of `CreateObject<>()`. They have configuration attributes.

An `ErrorModel` can be applied anywhere, but are commonly deployed on NetDevice models so that artificial losses (mimicking channel losses) can be induced.

#### Scope and Limitations

No known limitations. There are no existing models that try to modify the packet contents (e.g. apply bit or byte errors to the byte buffers). This type of operation will likely be performance-expensive, and existing Packet APIs may not easily support it.

The *ns-3* spectrum model and devices that derive from it (e.g. LTE) have their own error model base class, found in

#### References

The initial *ns-3* error models were ported from ns-2 (`queue/errmodel.{cc,h}`)

## 23.2.2 Usage

The base class API is as follows:

- `bool ErrorModel::IsCorrupt (Ptr<Packet> pkt)`: Evaluate the packet and return true or false whether the packet should be considered errored or not. Some models could potentially alter the contents of the packet bit buffer.
- `void ErrorModel::Reset (void)`: Reset any state.
- `void ErrorModel::Enable (void)`: Enable the model
- `void ErrorModel::Disble (void)`: Disable the model; `IsCorrupt()` will always return false.
- `bool ErrorModel::IsEnabled (void) const`: Return the enabled state

Many *ns-3* `NetDevices` contain attributes holding pointers to error models. The error model is applied in the notional physical layer processing chain of the device, and drops should show up on the `PhyRxDrop` trace source of the device. The following are known to include an attribute with a pointer available to hold this type of error model:

- `SimpleNetDevice`
- `PointToPointNetDevice`
- `CsmaNetDevice`
- `VirtualNetDevice`

However, the `ErrorModel` could be used anywhere where packets are used

### Helpers

This model is typically not used with helpers.

### Attributes

The `RateErrorModel` contains the following attributes:

### Output

What kind of data does the model generate? What are the key trace sources? What kind of logging output can be enabled?

### Examples

Error models are used in the tutorial `fifth` and `sixth` programs.

The directory `examples/error-model/` contains an example `simple-error-model.cc` that exercises the `Rate` and `List` error models.

The TCP example `examples/tcp/tcp-nsc-lfn.cc` uses the `Rate` error model.

### Troubleshooting

No known issues.

### 23.2.3 Validation

The `error-model` unit test suite provides a single test case of a particular combination of `ErrorRate` and `ErrorUnit` for the `RateErrorModel` applied to a `SimpleNetDevice`.

### 23.2.4 Acknowledgements

The basic `ErrorModel`, `RateErrorModel`, and `ListErrorModel` classes were ported from *ns-2* to *ns-3* in 2007. The `ReceiveListErrorModel` was added at that time.

The burst error model is due to Truc Anh N. Nguyen at the University of Kansas (James P.G. Sterbenz <jpgs@ittc.ku.edu>, director, ResiliNets Research Group (<http://wiki.ittc.ku.edu/resilinet>), Information and Telecommunication Technology Center (ITTC) and Department of Electrical Engineering and Computer Science, The University of Kansas Lawrence, KS USA). Work supported in part by NSF FIND (Future Internet Design) Program under grant CNS-0626918 (Postmodern Internet Architecture), NSF grant CNS-1050226 (Multilayer Network Resilience Analysis and Experimentation on GENI), US Department of Defense (DoD), and ITTC at The University of Kansas.

## 23.3 Node and NetDevices Overview

This chapter describes how *ns-3* nodes are put together, and provides a walk-through of how packets traverse an internet-based Node.

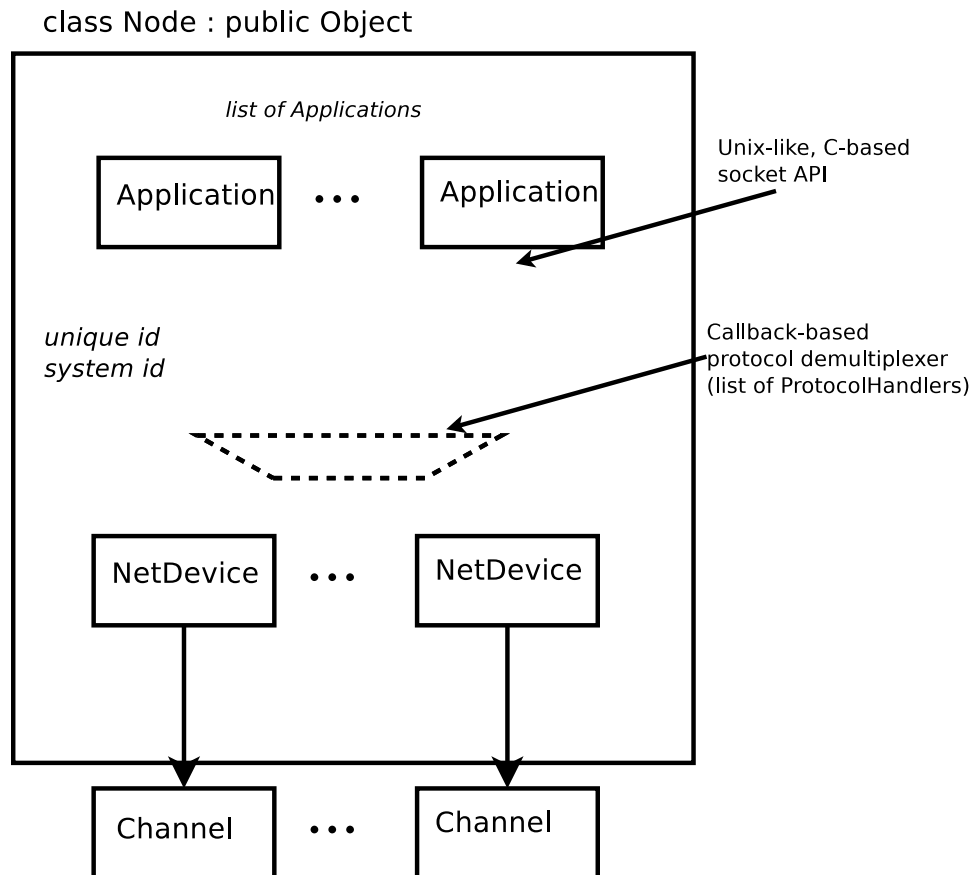

Fig. 3: High-level node architecture

In *ns-3*, nodes are instances of `ns3::Node`. This class may be subclassed, but instead, the conceptual model is that we *aggregate* or insert objects to it rather than define subclasses.

One might think of a bare *ns-3* node as a shell of a computer, to which one may add `NetDevices` (cards) and other innards including the protocols and applications. *High-level node architecture* illustrates that `ns3::Node` objects contain a list of `ns3::Application` instances (initially, the list is empty), a list of `ns3::NetDevice` instances (initially, the list is empty), a list of `ns3::Node::ProtocolHandler` instances, a unique integer ID, and a system ID (for distributed simulation).

The design tries to avoid putting too many dependencies on the class `ns3::Node`, `ns3::Application`, or `ns3::NetDevice` for the following:

- IP version, or whether IP is at all even used in the `ns3::Node`.
- implementation details of the IP stack.

From a software perspective, the lower interface of applications corresponds to the C-based sockets API. The upper interface of `ns3::NetDevice` objects corresponds to the device independent sublayer of the Linux stack. Everything in between can be aggregated and plumbed together as needed.

Let's look more closely at the protocol demultiplexer. We want incoming frames at layer-2 to be delivered to the right layer-3 protocol such as IPv4. The function of this demultiplexer is to register callbacks for receiving packets. The callbacks are indexed based on the `EtherType` in the layer-2 frame.

Many different types of higher-layer protocols may be connected to the `NetDevice`, such as IPv4, IPv6, ARP, MPLS, IEEE 802.1x, and packet sockets. Therefore, the use of a callback-based demultiplexer avoids the need to use a common base class for all of these protocols, which is problematic because of the different types of objects (including packet sockets) expected to be registered there.

## 23.4 Sockets APIs

The `sockets API` is a long-standing API used by user-space applications to access network services in the kernel. A *socket* is an abstraction, like a Unix file handle, that allows applications to connect to other Internet hosts and exchange reliable byte streams and unreliable datagrams, among other services.

*ns-3* provides two types of sockets APIs, and it is important to understand the differences between them. The first is a *native ns-3* API, while the second uses the services of the native API to provide a *POSIX-like* API as part of an overall application process. Both APIs strive to be close to the typical sockets API that application writers on Unix systems are accustomed to, but the POSIX variant is much closer to a real system's sockets API.

### 23.4.1 ns-3 sockets API

The native sockets API for *ns-3* provides an interface to various types of transport protocols (TCP, UDP) as well as to packet sockets and, in the future, Netlink-like sockets. However, users are cautioned to understand that the semantics are *not* the exact same as one finds in a real system (for an API which is very much aligned to real systems, see the next section).

`ns3::Socket` is defined in `src/network/model/socket.h`. Readers will note that many public member functions are aligned with real sockets function calls, and all other things being equal, we have tried to align with a Posix sockets API. However, note that:

- *ns-3* applications handle a smart pointer to a `Socket` object, not a file descriptor;
- there is no notion of synchronous API or a *blocking* API; in fact, the model for interaction between application and socket is one of asynchronous I/O, which is not typically found in real systems (more on this below);
- the C-style socket address structures are not used;

- the API is not a complete sockets API, such as supporting all socket options or all function variants;
- many calls use `ns3::Packet` class to transfer data between application and socket. This may seem peculiar to pass *Packets* across a stream socket API, but think of these packets as just fancy byte buffers at this level (more on this also below).

### Basic operation and calls

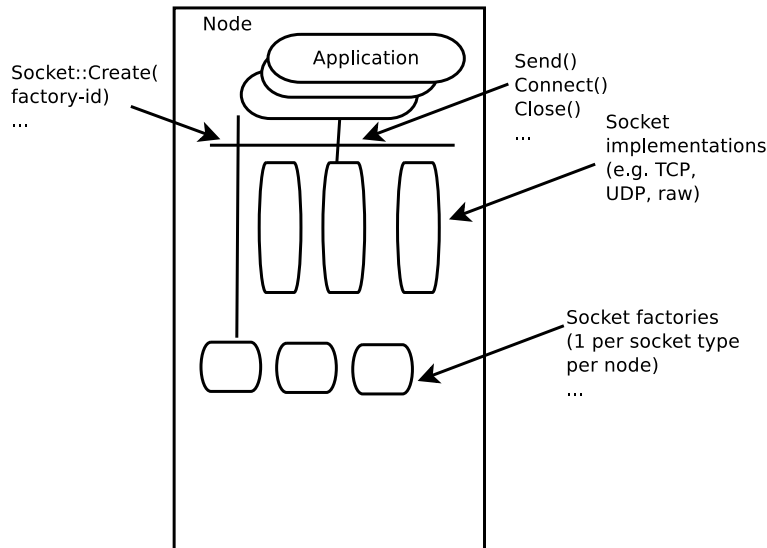

Fig. 4: Implementation overview of native sockets API

### Creating sockets

An application that wants to use sockets must first create one. On real systems using a C-based API, this is accomplished by calling `socket()`

```
int socket(int domain, int type, int protocol);
```

which creates a socket in the system and returns an integer descriptor.

In ns-3, we have no equivalent of a system call at the lower layers, so we adopt the following model. There are certain *factory* objects that can create sockets. Each factory is capable of creating one type of socket, and if sockets of a particular type are able to be created on a given node, then a factory that can create such sockets must be aggregated to the Node:

```
static Ptr<Socket> CreateSocket (Ptr<Node> node, TypeId tid);
```

Examples of `TypeId`s to pass to this method are `ns3::TcpSocketFactory`, `ns3::PacketSocketFactory`, and `ns3::UdpSocketFactory`.

This method returns a smart pointer to a `Socket` object. Here is an example:

```
Ptr<Node> n0;
// Do some stuff to build up the Node's internet stack
Ptr<Socket> localSocket =
    Socket::CreateSocket (n0, TcpSocketFactory::GetTypeId ());
```

In some ns-3 code, sockets will not be explicitly created by user's main programs, if an ns-3 application does it. For instance, for `ns3::OnOffApplication`, the function `ns3::OnOffApplication::StartApplication()` performs the socket creation, and the application holds the socket pointer.

## Using sockets

Below is a typical sequence of socket calls for a TCP client in a real implementation:

```
sock = socket(PF_INET, SOCK_STREAM, IPPROTO_TCP);
bind(sock, ...);
connect(sock, ...);
send(sock, ...);
recv(sock, ...);
close(sock);
```

There are analogs to all of these calls in ns-3, but we will focus on two aspects here. First, most usage of sockets in real systems requires a way to manage I/O between the application and kernel. These models include *blocking sockets*, *signal-based I/O*, and *non-blocking sockets* with polling. In ns-3, we make use of the callback mechanisms to support a fourth mode, which is analogous to POSIX *asynchronous I/O*.

In this model, on the sending side, if the `send()` call were to fail because of insufficient buffers, the application suspends the sending of more data until a function registered at the `ns3::Socket::SetSendCallback()` callback is invoked. An application can also ask the socket how much space is available by calling `ns3::Socket::GetTxAvailable()`. A typical sequence of events for sending data (ignoring connection setup) might be:

```
SetSendCallback (MakeCallback(&HandleSendCallback));
Send ();
Send ();
...
// Send fails because buffer is full
// Wait until HandleSendCallback is called
// HandleSendCallback is called by socket, since space now available
Send (); // Start sending again
```

Similarly, on the receive side, the socket user does not block on a call to `recv()`. Instead, the application sets a callback with `ns3::Socket::SetRecvCallback()` in which the socket will notify the application when (and how much) there is data to be read, and the application then calls `ns3::Socket::Recv()` to read the data until no more can be read.

### 23.4.2 Packet vs. buffer variants

There are two basic variants of `Send()` and `Recv()` supported:

```
virtual int Send (Ptr<Packet> p) = 0;
int Send (const uint8_t* buf, uint32_t size);

Ptr<Packet> Recv (void);
int Recv (uint8_t* buf, uint32_t size);
```

The non-Packet variants are provided for legacy API reasons. When calling the raw buffer variant of `ns3::Socket::Send()`, the buffer is immediately written into a Packet and the packet variant is invoked.

Users may find it semantically odd to pass a Packet to a stream socket such as TCP. However, do not let the name bother you; think of `ns3::Packet` to be a fancy byte buffer. There are a few reasons why the Packet variants are more likely to be preferred in ns-3:

- Users can use the Tags facility of packets to, for example, encode a flow ID or other helper data at the application layer.
- Users can exploit the copy-on-write implementation to avoid memory copies (on the receive side, the conversion back to a `uint8_t* buf` may sometimes incur an additional copy).
- Use of Packet is more aligned with the rest of the ns-3 API

### 23.4.3 Sending dummy data

Sometimes, users want the simulator to just pretend that there is an actual data payload in the packet (e.g. to calculate transmission delay) but do not want to actually produce or consume the data. This is straightforward to support in ns-3; have applications call `Create<Packet> (size);` instead of `Create<Packet> (buffer, size);`. Similarly, passing in a zero to the pointer argument in the raw buffer variants has the same effect. Note that, if some subsequent code tries to read the Packet data buffer, the fake buffer will be converted to a real (zeroed) buffer on the spot, and the efficiency will be lost there.

### 23.4.4 Use of Send() vs. SendTo()

There are two variants of methods used to send data to the socket:

```
virtual int Send (Ptr<Packet> p, uint32_t flags) = 0;

virtual int SendTo (Ptr<Packet> p, uint32_t flags,
                  const Address &toAddress) = 0;
```

The first method is used if the socket has already been connected (`Socket::Connect()`) to a peer address. In the case of stream-based sockets like TCP, the connect call is required to bind the socket to a peer address, and thereafter, `Send()` is typically used. In the case of datagram-based sockets like UDP, the socket is not required to be connected to a peer address before sending, and the socket may be used to send data to different destination addresses; in this case, the `SendTo()` method is used to specify the destination address for the datagram.

### 23.4.5 Socket options

#### ToS (Type of Service)

The native sockets API for ns-3 provides two public methods (of the Socket base class):

```
void SetIpTos (uint8_t ipTos);
uint8_t GetIpTos (void) const;
```

to set and get, respectively, the type of service associated with the socket. These methods are equivalent to using the `IP_TOS` option of BSD sockets. Clearly, setting the type of service only applies to sockets using the IPv4 protocol. However, users typically do not set the type of service associated with a socket through `ns3::Socket::SetIpTos()` because sockets are normally created by application helpers and users cannot get a pointer to the sockets. Instead, users can create an address of type `ns3::InetSocketAddress` with the desired type of service value and pass it to the application helpers:

```
InetSocketAddress destAddress (ipv4Address, udpPort);
destAddress.SetTos (tos);
OnOffHelper onoff ("ns3::UdpSocketFactory", destAddress);
```

For this to work, the application must eventually call the `ns3::Socket::Connect()` method to connect to the provided `destAddress` and the `Connect` method of the particular socket type must support setting the type of service associated with a socket (by using the `ns3::Socket::SetIpTos()` method). Currently, the socket types that support setting the type of service in such a way are `ns3::UdpSocketImpl` and `ns3::TcpSocketBase`.

The type of service associated with a socket is then used to determine the value of the Type of Service field (renamed as Differentiated Services field by RFC 2474) of the IPv4 header of the packets sent through that socket, as detailed in the next sections.

### Setting the ToS with UDP sockets

For IPv4 packets, the ToS field is set according to the following rules:

- If the socket is connected, the ToS field is set to the ToS value associated with the socket.
- If the socket is not connected, the ToS field is set to the value specified in the destination address (of type `ns3::InetSocketAddress`) passed to `ns3::Socket::SendTo()`, and the ToS value associated with the socket is ignored.

### Setting the ToS with TCP sockets

For IPv4 packets, the ToS field is set to the ToS value associated with the socket.

### Priority

The native sockets API for ns-3 provides two public methods (of the `Socket` base class):

```
void SetPriority (uint8_t priority);  
uint8_t GetPriority (void) const;
```

to set and get, respectively, the priority associated with the socket. These methods are equivalent to using the `SO_PRIORITY` option of BSD sockets. Only values in the range 0..6 can be set through the above method.

Note that setting the type of service associated with a socket (by calling `ns3::Socket::SetIpTos()`) also sets the priority for the socket to the value that the `ns3::Socket::IpTos2Priority()` function returns when it is passed the type of service value. This function is implemented after the Linux `rt_tos2priority` function, which takes an 8-bit value as input and returns a value which is a function of bits 3-6 (where bit 0 is the most significant bit) of the input value:

Bits 3-6	Priority
0 to 3	0 (Best Effort)
4 to 7	2 (Bulk)
8 to 11	6 (Interactive)
12 to 15	4 (Interactive Bulk)

The rationale is that bits 3-6 of the Type of Service field were interpreted as the TOS subfield by (the obsolete) RFC 1349. Readers can refer to the doxygen documentation of `ns3::Socket::IpTos2Priority()` for more information, including how DSCP values map onto priority values.

The priority set for a socket (as described above) is then used to determine the priority of the packets sent through that socket, as detailed in the next sections. Currently, the socket types that support setting the packet priority are `ns3::UdpSocketImpl`, `ns3::TcpSocketBase` and `ns3::PacketSocket`. The packet priority is used, e.g., by queuing disciplines such as the default `PfifoFastQueueDisc` to classify packets into distinct queues.



### Setting the priority with UDP sockets

If the packet is an IPv4 packet and the value to be inserted in the ToS field is not null, then the packet is assigned a priority based on such ToS value (according to the `ns3::Socket::IpTos2Priority()` function). Otherwise, the priority associated with the socket is assigned to the packet.

### Setting the priority with TCP sockets

Every packet is assigned a priority equal to the priority associated with the socket.

### Setting the priority with packet sockets

Every packet is assigned a priority equal to the priority associated with the socket.

## 23.4.6 Socket errno

*to be completed*

## 23.4.7 Example programs

*to be completed*

## 23.4.8 POSIX-like sockets API

# 23.5 Simple NetDevice

*Placeholder chapter*

## 23.6 Queues

This section documents the queue object, which is typically used by NetDevices and QueueDiscs to store packets.

Packets stored in a queue can be managed according to different policies. Currently, only the DropTail policy is available.

### 23.6.1 Model Description

The source code for the new module lives in the directory `src/network/utls`.

`ns3::Queue` has been redesigned as a template class object to allow us to instantiate queues storing different types of items. The unique template type parameter specifies the type of items stored in the queue. The only requirement on the item type is that it must provide a `GetSize()` method which returns the size of the packet included in the item. Currently, queue items can be objects of the following classes:

- Packet
- QueueItem and subclasses (e.g., QueueDiscItem)

- `WifiMacQueueItem`

The internal queues of the queue discs are of type `Queue<QueueDiscItem>` (an alias of which being `InternalQueue`). A number of network devices (`SimpleNetDevice`, `PointToPointNetDevice`, `CsmaNetDevice`) use a `Queue<Packet>` to store packets to be transmitted. `WifiNetDevices` use instead queues of type `WifiMacQueue`, which is a subclass of `Queue` storing objects of type `WifiMacQueueItem`. Other devices, such as `WiMax` and `LTE`, use specialized queues.

### Design

The `Queue` class derives from the `QueueBase` class, which is a non-template class providing all the methods that are independent of the type of the items stored in the queue. The `Queue` class provides instead all the operations that depend on the item type, such as `enqueue`, `dequeue`, `peek` and `remove`. The `Queue` class also provides the ability to trace certain queue operations such as enqueueing, dequeueing, and dropping.

`Queue` is an abstract base class and is subclassed for specific scheduling and drop policies. Subclasses need to define the following public methods:

- `bool Enqueue (Ptr<Item> item):` Enqueue a packet
- `Ptr<Item> Dequeue (void):` Dequeue a packet
- `Ptr<Item> Remove (void):` Remove a packet
- `Ptr<const Item> Peek (void):` Peek a packet

The `Enqueue` method does not allow to store a packet if the queue capacity is exceeded. Subclasses may also define specialized public methods. For instance, the `WifiMacQueue` class provides a method to dequeue a packet based on its `tid` and `MAC` address.

There are five trace sources that may be hooked:

- `Enqueue`
- `Dequeue`
- `Drop`
- `DropBeforeEnqueue`
- `DropAfterDequeue`

Also, the `QueueBase` class defines two additional trace sources:

- `PacketsInQueue`
- `BytesInQueue`

### DropTail

This is a basic first-in-first-out (FIFO) queue that performs a tail drop when the queue is full.

The `DropTailQueue` class defines one attribute:

- `MaxSize:` the maximum queue size

## 23.6.2 Usage

### Helpers

A typical usage pattern is to create a device helper and to configure the queue type and attributes from the helper, such as this example:

```
PointToPointHelper p2p;

p2p.SetQueue ("ns3::DropTailQueue");
p2p.SetDeviceAttribute ("DataRate", StringValue ("10Mbps"));
p2p.SetChannelAttribute ("Delay", StringValue ("2ms"));
NetDeviceContainer devn0n2 = p2p.Install (n0n2);

p2p.SetQueue ("ns3::DropTailQueue");
p2p.SetDeviceAttribute ("DataRate", StringValue ("10Mbps"));
p2p.SetChannelAttribute ("Delay", StringValue ("3ms"));
NetDeviceContainer devn1n2 = p2p.Install (n1n2);

p2p.SetQueue ("ns3::DropTailQueue",
              "MaxSize", StringValue ("50p"));
p2p.SetDeviceAttribute ("DataRate", StringValue (linkDataRate));
p2p.SetChannelAttribute ("Delay", StringValue (linkDelay));
NetDeviceContainer devn2n3 = p2p.Install (n2n3);
```

Please note that the `SetQueue` method of the `PointToPointHelper` class allows to specify “`ns3::DropTailQueue`” instead of “`ns3::DropTailQueue<Packet>`”. The same holds for `CsmaHelper`, `SimpleNetDeviceHelper` and `TrafficControlHelper`.

### Output

The ns-3 ascii trace helpers used by many of the `NetDevices` will hook the `Enqueue`, `Dequeue`, and `Drop` traces of these queues and print out trace statements, such as the following from `examples/udp/udp-echo.cc`:

```
+ 2 /NodeList/0/DeviceList/1/$ns3::CsmaNetDevice/TxQueue/Enqueue ns3::EthernetHeader
( length/type=0x806, source=00:00:00:00:00:01, destination=ff:ff:ff:ff:ff:ff)
ns3::ArpHeader (request source mac: 00-06-00:00:00:00:00:01 source ipv4: 10.1.1.1
dest ipv4: 10.1.1.2) Payload (size=18) ns3::EthernetTrailer (fcs=0)
- 2 /NodeList/0/DeviceList/1/$ns3::CsmaNetDevice/TxQueue/Dequeue ns3::EthernetHeader
( length/type=0x806, source=00:00:00:00:00:01, destination=ff:ff:ff:ff:ff:ff)
ns3::ArpHeader (request source mac: 00-06-00:00:00:00:00:01 source ipv4: 10.1.1.1
dest ipv4: 10.1.1.2) Payload (size=18) ns3::EthernetTrailer (fcs=0)
```

which shows an enqueue “+” and dequeue “-” event at time 2 seconds.

Users are, of course, free to define and hook their own trace sinks to these trace sources.

### Examples

The drop-tail queue is used in several examples, such as `examples/udp/udp-echo.cc`.

## 23.7 Queue limits

This section documents the queue limits model, which is used by the traffic control to limit the NetDevices queueing delay. It operates on the transmission path of the network node.

The reduction of the NetDevices queueing delay is essential to improve the effectiveness of Active Queue Management (AQM) algorithms. Careful assessment of the queueing delay includes a byte-based measure of the NetDevices queue length. In this design, traffic control can use different byte-based schemes to limit the queueing delay. Currently the only available scheme is DynamicQueueLimits, which is modelled after the dynamic queue limit library of Linux.

### 23.7.1 Model Description

The source code for the model lives in the directory `src/network/utils`.

The model allows a byte-based measure of the netdevice queue. The byte-based measure more accurately approximates the time required to empty the queue than a packet-based measure.

To inform the upper layers about the transmission of packets, NetDevices can call a couple of functions:

- `void NotifyQueuedBytes (uint32_t bytes)`: Report the number of bytes queued to the device queue
- `void NotifyTransmittedBytes (uint32_t bytes)`: Report the number of bytes transmitted by device

Based on this information, the QueueLimits object can stop the transmission queue.

In case of multiqueue NetDevices this mechanism is available for each queue.

The QueueLimits model can be used on any NetDevice modelled in ns-3.

### Design

An abstract base class, class QueueLimits, is subclassed for specific byte-based limiting strategies.

Common operations provided by the base class QueueLimits include:

- `void Reset ()`: Reset queue limits state
- `void Completed (uint32_t count)`: Record the number of completed bytes and recalculate the limit
- `int32_t Available () const`: Return how many bytes can be queued
- `void Queued (uint32_t count)`: Record number of bytes queued

### DynamicQueueLimits

Dynamic queue limits (DQL) is a basic library implemented in the Linux kernel to limit the Ethernet queueing delay. DQL is a general purpose queue length controller. The goal of DQL is to calculate the limit as the minimum number of bytes needed to prevent starvation.

Three attributes are defined in the DynamicQueueLimits class:

- `HoldTime`: The DQL algorithm hold time
- `MaxLimit`: Maximum limit
- `MinLimit`: Minimum limit

The DQL algorithm hold time is 1 s. Reducing the HoldTime increases the responsiveness of DQL with consequent greater number of limit variation events. Conversely, increasing the HoldTime decreases the responsiveness of DQL with a minor number of limit variation events. The limit calculated by DQL is in the range from MinLimit to MaxLimit. The default values are respectively 0 and DQL\_MAX\_LIMIT. Increasing the MinLimit is recommended in case of higher NetDevice transmission rate (e.g. 1 Gbps) while reducing the MaxLimit is recommended in case of lower NetDevice transmission rate (e.g. 500 Kbps).

There is one trace source in DynamicQueueLimits class that may be hooked:

- `Limit`: Limit value calculated by DQL

## 23.7.2 Usage

### Helpers

A typical usage pattern is to create a traffic control helper and configure the queue limits type and attributes from the helper, such as this example:

```
TrafficControlHelper tch;
uint32_t handle = tch.SetRootQueueDisc ("ns3::PfifoFastQueueDisc", "Limit",
↳UIntegerValue (1000));

tch.SetQueueLimits ("ns3::DynamicQueueLimits", "HoldTime", StringValue ("4ms"));
```

then install the configuration on a NetDevices container

```
tch.Install (devices);
```



## NIX-VECTOR ROUTING DOCUMENTATION

Nix-vector routing is a simulation specific routing protocol and is intended for large network topologies. The on-demand nature of this protocol as well as the low-memory footprint of the nix-vector provides improved performance in terms of memory usage and simulation run time when dealing with a large number of nodes.

### 24.1 Model Description

The source code for the `NixVectorRouting` module lives in the directory `src/nix-vector-routing`.

*ns-3* `nix-vector-routing` performs on-demand route computation using a breadth-first search and an efficient route-storage data structure known as a nix-vector.

When a packet is generated at a node for transmission, the route is calculated, and the nix-vector is built. The nix-vector stores an index for each hop along the path, which corresponds to the neighbor-index. This index is used to determine which net-device and gateway should be used. To route a packet, the nix-vector must be transmitted with the packet. At each hop, the current node extracts the appropriate neighbor-index from the nix-vector and transmits the packet through the corresponding net-device. This continues until the packet reaches the destination.

#### 24.1.1 Scope and Limitations

Currently, the *ns-3* model of nix-vector routing supports IPv4 p2p links as well as CSMA links. It does not (yet) provide support for efficient adaptation to link failures. It simply flushes all nix-vector routing caches. Finally, IPv6 is not supported.

### 24.2 Usage

The usage pattern is the one of all the Internet routing protocols. Since `NixVectorRouting` is not installed by default in the Internet stack, it is necessary to set it in the Internet Stack helper by using `InternetStackHelper::SetRoutingHelper`

#### 24.2.1 Examples

The examples for the `NixVectorRouting` module lives in the directory `src/nix-vector-routing/examples`.





## OPTIMIZED LINK STATE ROUTING (OLSR)

This model implements the base specification of the Optimized Link State Routing (OLSR) protocol, which is a dynamic mobile ad hoc unicast routing protocol. It has been developed at the University of Murcia (Spain) by Francisco J. Ros for NS-2, and was ported to NS-3 by Gustavo Carneiro at INESC Porto (Portugal).

The implementation is based on OLSR Version 1 ([RFC 3626](#) [rfc3626]) and it is *not* compliant with OLSR Version 2 ([RFC 7181](#) [rfc7181]) or any of the Version 2 extensions.

### 25.1 Model Description

The source code for the OLSR model lives in the directory `src/olsr`. As stated before, the model is based on [RFC 3626](#) ([rfc3626]). Moreover, many design choices are based on the previous ns2 model.

#### 25.1.1 Scope and Limitations

The model is for IPv4 only.

- Mostly compliant with OLSR as documented in [RFC 3626](#) ([rfc3626]),
- The use of multiple interfaces was not supported by the NS-2 version, but is supported in NS-3;
- OLSR does not respond to the routing event notifications corresponding to dynamic interface up and down (`ns3::RoutingProtocol::NotifyInterfaceUp` and `ns3::RoutingProtocol::NotifyInterfaceDown`) or address insertion/removal (`ns3::RoutingProtocol::NotifyAddAddress` and `ns3::RoutingProtocol::NotifyRemoveAddress`).
- Unlike the NS-2 version, does not yet support MAC layer feedback as described in [RFC 3626](#) ([rfc3626]);

Host Network Association (HNA) is supported in this implementation of OLSR. Refer to `examples/olsr-hna.cc` to see how the API is used.

#### 25.1.2 References

### 25.2 Usage

The usage pattern is the one of all the Internet routing protocols. Since OLSR is not installed by default in the Internet stack, it is necessary to set it in the Internet Stack helper by using `InternetStackHelper::SetRoutingHelper`

Typically, OLSR is enabled in a main program by use of an `OlsrHelper` class that installs OLSR into an `Ipv4ListRoutingProtocol` object. The following sample commands will enable OLSR in a simulation using this helper

class along with some other routing helper objects. The setting of priority value 10, ahead of the staticRouting priority of 0, means that OLSR will be consulted for a route before the node's static routing table.:

```
NodeContainer c;
...
// Enable OLSR
NS_LOG_INFO ("Enabling OLSR Routing.");
OlsrHelper olsr;

Ipv4StaticRoutingHelper staticRouting;

Ipv4ListRoutingHelper list;
list.Add (staticRouting, 0);
list.Add (olsr, 10);

InternetStackHelper internet;
internet.SetRoutingHelper (list);
internet.Install (c);
```

Once installed, the OLSR “main interface” can be set with the `SetMainInterface()` command. If the user does not specify a main address, the protocol will select the first primary IP address that it finds, starting first the loopback interface and then the next non-loopback interface found, in order of Ipv4 interface index. The loopback address of 127.0.0.1 is not selected. In addition, a number of protocol constants are defined in `olsr-routing-protocol.cc`.

Olsr is started at time zero of the simulation, based on a call to `Object::Start()` that eventually calls `OlsrRoutingProtocol::DoStart()`. Note: a patch to allow the user to start and stop the protocol at other times would be welcome.

## 25.2.1 Examples

The examples are in the `src/olsr/examples/` directory. However, many other examples exist in the general examples directory, e.g., `examples/routing/manet-routing-compare.cc`.

For specific examples of the HNA feature, see the examples in `src/olsr/examples/`.

## 25.2.2 Helpers

A helper class for OLSR has been written. After an IPv4 topology has been created and unique IP addresses assigned to each node, the simulation script writer can call one of three overloaded functions with different scope to enable OLSR: `ns3::OlsrHelper::Install (NodeContainer container); ns3::OlsrHelper::Install (Ptr<Node> node);` or `ns3::OlsrHelper::InstallAll (void)`

## 25.2.3 Attributes

In addition, the behavior of OLSR can be modified by changing certain attributes. The method `ns3::OlsrHelper::Set ()` can be used to set OLSR attributes. These include `HelloInterval`, `TcInterval`, `MidInterval`, `Willingness`. Other parameters are defined as macros in `olsr-routing-protocol.cc`.

The list of configurable attributes is:

- `HelloInterval` (time, default 2s), HELLO messages emission interval.
- `TcInterval` (time, default 5s), TC messages emission interval.
- `MidInterval` (time, default 5s), MID messages emission interval.
- `HnaInterval` (time, default 5s), HNA messages emission interval.

- Willingness (enum, default OLSR\_WILL\_DEFAULT), Willingness of a node to carry and forward traffic for other nodes.

## 25.2.4 Tracing

The available traces are:

- Rx: Receive OLSR packet.
- Tx: Send OLSR packet.
- RoutingTableChanged: The OLSR routing table has changed.

## 25.2.5 Caveats

Presently, OLSR is limited to use with an Ipv4ListRouting object, and does not respond to dynamic changes to a device's IP address or link up/down notifications; i.e. the topology changes are due to loss/gain of connectivity over a wireless channel.

The code does not present any known issue.

## 25.3 Validation

The code validation has been done through Wireshark message compliance and unit testings.



## OPENFLOW SWITCH SUPPORT

ns-3 simulations can use OpenFlow switches (McKeown et al.<sup>1</sup>), widely used in research. OpenFlow switches are configurable via the OpenFlow API, and also have an MPLS extension for quality-of-service and service-level-agreement support. By extending these capabilities to ns-3 for a simulated OpenFlow switch that is both configurable and can use the MPLS extension, ns-3 simulations can accurately simulate many different switches.

The OpenFlow software implementation distribution is hereby referred to as the OFSID. This is a demonstration of running OpenFlow in software that the OpenFlow research group has made available. There is also an OFSID that Ericsson researchers created to add MPLS capabilities; this is the OFSID currently used with ns-3. The design will allow the users to, with minimal effort, switch in a different OFSID that may include more efficient code than a previous OFSID.

### 26.1 Model Description

The model relies on building an external OpenFlow switch library (OFSID), and then building some ns-3 wrappers that call out to the library. The source code for the ns-3 wrappers lives in the directory `src/openflow/model`.

#### 26.1.1 Design

The OpenFlow module presents a `OpenFlowSwitchNetDevice` and a `OpenFlowSwitchHelper` for installing it on nodes. Like the `Bridge` module, it takes a collection of `NetDevices` to set up as ports, and it acts as the intermediary between them, receiving a packet on one port and forwarding it on another, or all but the received port when flooding. Like an OpenFlow switch, it maintains a configurable flow table that can match packets by their headers and do different actions with the packet based on how it matches. The module's understanding of OpenFlow configuration messages are kept the same format as a real OpenFlow-compatible switch, so users testing Controllers via ns-3 won't have to rewrite their Controller to work on real OpenFlow-compatible switches.

The ns-3 OpenFlow switch device models an OpenFlow-enabled switch. It is designed to express basic use of the OpenFlow protocol, with the maintaining of a virtual Flow Table and TCAM to provide OpenFlow-like results.

The functionality comes down to the Controllers, which send messages to the switch that configure its flows, producing different effects. Controllers can be added by the user, under the `ofi` namespace extending `ofi::Controller`. To demonstrate this, a `DropController`, which creates flows for ignoring every single packet, and `LearningController`, which effectively makes the switch a more complicated `BridgeNetDevice`. A user versed in a standard OFSID, and/or OF protocol, can write virtual controllers to create switches of all kinds of types.

---

<sup>1</sup> McKeown, N.; Anderson, T.; Balakrishnan, H.; Parulkar, G.; Peterson, L.; Rexford, J.; Shenker, S.; Turner, J.; OpenFlow: enabling innovation in campus networks, ACM SIGCOMM Computer Communication Review, Vol. 38, Issue 2, April 2008.

## OpenFlow switch Model

The OpenFlow switch device behaves somewhat according to the diagram setup as a classical OFSID switch, with a few modifications made for a proper simulation environment.

Normal OF-enabled Switch:

```
| Secure Channel | <--OF Protocol--> | Controller is external |  
| Hardware or Software Flow Table |
```

ns-3 OF-enabled Switch (module):

```
| m_controller->ReceiveFromSwitch() | <--OF Protocol--> | Controller is internal |  
| Software Flow Table, virtual TCAM |
```

In essence, there are two differences:

1) No SSL, Embedded Controller: Instead of a secure channel and connecting to an outside location for the Controller program/machine, we currently only allow a Controller extended from `ofi::Controller`, an extension of an `ns3::Object`. This means ns-3 programmers cannot model the SSL part of the interface or possibility of network failure. The connection to the OpenFlowSwitch is local and there aren't any reasons for the channel/connection to break down. <<This difference may be an option in the future. Using EmuNetDevices, it should be possible to engage an external Controller program/machine, and thus work with controllers designed outside of the ns-3 environment, that simply use the proper OF protocol when communicating messages to the switch through a tap device.>>

2) Virtual Flow Table, TCAM: Typical OF-enabled switches are implemented on a hardware TCAM. The OFSID we turn into a library includes a modelled software TCAM, that produces the same results as a hardware TCAM. We include an attribute `FlowTableLookupDelay`, which allows a simple delay of using the TCAM to be modelled. We don't endeavor to make this delay more complicated, based on the tasks we are running on the TCAM, that is a possible future improvement.

The OpenFlowSwitch network device is aimed to model an OpenFlow switch, with a TCAM and a connection to a controller program. With some tweaking, it can model every switch type, per OpenFlow's extensibility. It outsources the complexity of the switch ports to NetDevices of the user's choosing. It should be noted that these NetDevices must behave like practical switch ports, i.e. a Mac Address is assigned, and nothing more. It also must support a `SendFrom` function so that the OpenFlowSwitch can forward across that port.

### 26.1.2 Scope and Limitations

All MPLS capabilities are implemented on the OFSID side in the `OpenFlowSwitchNetDevice`, but `ns-3-mpls` hasn't been integrated, so ns-3 has no way to pass in proper MPLS packets to the OpenFlowSwitch. If it did, one would only need to make `BufferFromPacket` pick up the `MplsLabelStack` or whatever the MPLS header is called on the Packet, and build the MPLS header into the `ofpbuf`.

### 26.1.3 Future Work

### 26.1.4 References

## 26.2 Usage

The OFSID requires `libxml2` (for MPLS FIB xml file parsing), `libdl` (for address fault checking), and `boost` (for assert) libraries to be installed.

## 26.2.1 Building OFSID

In order to use the OpenFlowSwitch module, you must create and link the OFSID (OpenFlow Software Implementation Distribution) to ns-3. To do this:

1. Obtain the OFSID code. An ns-3 specific OFSID branch is provided to ensure operation with ns-3. Use mercurial to download this branch and waf to build the library:

```
$ hg clone http://code.nsnam.org/openflow
$ cd openflow
```

From the “openflow” directory, run:

```
$ ./waf configure
$ ./waf build
```

2. Your OFSID is now built into a libopenflow.a library! To link to an ns-3 build with this OpenFlow switch module, run from the ns-3-dev (or whatever you have named your distribution):

```
$ ./waf configure --enable-examples --enable-tests --with-openflow=path/to/
↳openflow
```

3. Under ---- Summary of optional NS-3 features: you should see:

```
"NS-3 OpenFlow Integration      : enabled"
```

indicating the library has been linked to ns-3. Run:

```
$ ./waf build
```

to build ns-3 and activate the OpenFlowSwitch module in ns-3.

## 26.2.2 Examples

For an example demonstrating its use in a simple learning controller/switch, run:

```
$ ./waf --run openflow-switch
```

To see it in detailed logging, run:

```
$ ./waf --run "openflow-switch -v"
```

## 26.2.3 Helpers

## 26.2.4 Attributes

The SwitchNetDevice provides following Attributes:

- FlowTableLookUpDelay: This time gets run off the clock when making a lookup in our Flow Table.
- **Flags: OpenFlow specific configuration flags. They are defined in the ofp\_config\_flags enum. Choices include:**
  - OFPC\_SEND\_FLOW\_EXP (Switch notifies controller when a flow has expired),
  - OFPC\_FRAG\_NORMAL (Match fragment against Flow table),
  - OFPC\_FRAG\_DROP (Drop fragments),
  - OFPC\_FRAG\_REASM (Reassemble only if OFPC\_IP\_REASM set, which is currently impossible, because switch implementation does not support IP reassembly)
  - OFPC\_FRAG\_MASK (Mask Fragments)

- **FlowTableMissSendLength:** When the packet doesn't match in our Flow Table, and we forward to the controller, this sets # of bytes forwarded (packet is not forwarded in its entirety, unless specified).

---

**Note:** TODO

---

### 26.2.5 Tracing

---

**Note:** TODO

---

### 26.2.6 Logging

---

**Note:** TODO

---

### 26.2.7 Caveats

---

**Note:** TODO

---

## 26.3 Validation

This model has one test suite which can be run as follows:

```
$ ./test.py --suite=openflow
```



## POINTTOPOINT NETDEVICE

This is the introduction to PointToPoint NetDevice chapter, to complement the PointToPoint model doxygen.

### 27.1 Overview of the PointToPoint model

The *ns-3* point-to-point model is of a very simple point to point data link connecting exactly two PointToPointNetDevice devices over an PointToPointChannel. This can be viewed as equivalent to a full duplex RS-232 or RS-422 link with null modem and no handshaking.

Data is encapsulated in the Point-to-Point Protocol (PPP – RFC 1661), however the Link Control Protocol (LCP) and associated state machine is not implemented. The PPP link is assumed to be established and authenticated at all times.

Data is not framed, therefore Address and Control fields will not be found. Since the data is not framed, there is no need to provide Flag Sequence and Control Escape octets, nor is a Frame Check Sequence appended. All that is required to implement non-framed PPP is to prepend the PPP protocol number for IP Version 4 which is the sixteen-bit number 0x21 (see <http://www.iana.org/assignments/ppp-numbers>).

The PointToPointNetDevice provides following Attributes:

- Address: The ns3::Mac48Address of the device (if desired);
- DataRate: The data rate (ns3::DataRate) of the device;
- TxQueue: The transmit queue (ns3::Queue) used by the device;
- InterframeGap: The optional ns3::Time to wait between “frames”;
- Rx: A trace source for received packets;
- Drop: A trace source for dropped packets.

The PointToPointNetDevice models a transmitter section that puts bits on a corresponding channel “wire.” The DataRate attribute specifies the number of bits per second that the device will simulate sending over the channel. In reality no bits are sent, but an event is scheduled for an elapsed time consistent with the number of bits in each packet and the specified DataRate. The implication here is that the receiving device models a receiver section that can receive any data rate. Therefore there is no need, nor way to set a receive data rate in this model. By setting the DataRate on the transmitter of both devices connected to a given PointToPointChannel one can model a symmetric channel; or by setting different DataRates one can model an asymmetric channel (e.g., ADSL).

The PointToPointNetDevice supports the assignment of a “receive error model.” This is an ErrorModel object that is used to simulate data corruption on the link.

## 27.2 Point-to-Point Channel Model

The point to point net devices are connected via an `PointToPointChannel`. This channel models two wires transmitting bits at the data rate specified by the source net device. There is no overhead beyond the eight bits per byte of the packet sent. That is, we do not model Flag Sequences, Frame Check Sequences nor do we “escape” any data.

The `PointToPointChannel` provides following Attributes:

- Delay: An `ns3::Time` specifying the propagation delay for the channel.

## 27.3 Using the PointToPointNetDevice

The `PointToPoint` net devices and channels are typically created and configured using the associated `PointToPointHelper` object. The various ns3 device helpers generally work in a similar way, and their use is seen in many of our example programs and is also covered in the *ns-3* tutorial.

The conceptual model of interest is that of a bare computer “husk” into which you plug net devices. The bare computers are created using a `NodeContainer` helper. You just ask this helper to create as many computers (we call them `Nodes`) as you need on your network:

```
NodeContainer nodes;  
nodes.Create (2);
```

Once you have your nodes, you need to instantiate a `PointToPointHelper` and set any attributes you may want to change. Note that since this is a point-to-point (as compared to a point-to-multipoint) there may only be two nodes with associated net devices connected by a `PointToPointChannel`:

```
PointToPointHelper pointToPoint;  
pointToPoint.SetDeviceAttribute ("DataRate", StringValue ("5Mbps"));  
pointToPoint.SetChannelAttribute ("Delay", StringValue ("2ms"));
```

Once the attributes are set, all that remains is to create the devices and install them on the required nodes, and to connect the devices together using a `PointToPoint` channel. When we create the net devices, we add them to a container to allow you to use them in the future. This all takes just one line of code.:

```
NetDeviceContainer devices = pointToPoint.Install (nodes);
```

## 27.4 PointToPoint Tracing

Like all *ns-3* devices, the Point-to-Point Model provides a number of trace sources. These trace sources can be hooked using your own custom trace code, or you can use our helper functions to arrange for tracing to be enabled on devices you specify.

### 27.4.1 Upper-Level (MAC) Hooks

From the point of view of tracing in the net device, there are several interesting points to insert trace hooks. A convention inherited from other simulators is that packets destined for transmission onto attached networks pass through a single “transmit queue” in the net device. We provide trace hooks at this point in packet flow, which corresponds (abstractly) only to a transition from the network to data link layer, and call them collectively the device MAC hooks.

When a packet is sent to the Point-to-Point net device for transmission it always passes through the transmit queue. The transmit queue in the `PointToPointNetDevice` inherits from `Queue`, and therefore inherits three trace sources:

- An Enqueue operation source (see `ns3::Queue::m_traceEnqueue`);
- A Dequeue operation source (see `ns3::Queue::m_traceDequeue`);
- A Drop operation source (see `ns3::Queue::m_traceDrop`).

The upper-level (MAC) trace hooks for the `PointToPointNetDevice` are, in fact, exactly these three trace sources on the single transmit queue of the device.

The `m_traceEnqueue` event is triggered when a packet is placed on the transmit queue. This happens at the time that `ns3::PointToPointNetDevice::Send` or `ns3::PointToPointNetDevice::SendFrom` is called by a higher layer to queue a packet for transmission. An Enqueue trace event firing should be interpreted as only indicating that a higher level protocol has sent a packet to the device.

The `m_traceDequeue` event is triggered when a packet is removed from the transmit queue. Dequeues from the transmit queue can happen in two situations: 1) If the underlying channel is idle when `PointToPointNetDevice::Send` is called, a packet is dequeued from the transmit queue and immediately transmitted; 2) a packet may be dequeued and immediately transmitted in an internal `TransmitCompleteEvent` that functions much like a transmit complete interrupt service routine. An Dequeue trace event firing may be viewed as indicating that the `PointToPointNetDevice` has begun transmitting a packet.

## 27.4.2 Lower-Level (PHY) Hooks

Similar to the upper level trace hooks, there are trace hooks available at the lower levels of the net device. We call these the PHY hooks. These events fire from the device methods that talk directly to the `PointToPointChannel`.

The trace source `m_dropTrace` is called to indicate a packet that is dropped by the device. This happens when a packet is discarded as corrupt due to a receive error model indication (see `ns3::ErrorModel` and the associated attribute “`ReceiveErrorModel`”).

The other low-level trace source fires on reception of a packet (see `ns3::PointToPointNetDevice::m_rxTrace`) from the `PointToPointChannel`.



## PROPAGATION

The *ns-3* propagation module defines two generic interfaces, namely `PropagationLossModel` and `PropagationDelayModel`, to model respectively the propagation loss and the propagation delay.

### 28.1 PropagationLossModel

Propagation loss models calculate the Rx signal power considering the Tx signal power and the mutual Rx and Tx antennas positions.

A propagation loss model can be “chained” to another one, making a list. The final Rx power takes into account all the chained models. In this way one can use a slow fading and a fast fading model (for example), or model separately different fading effects.

The following propagation loss models are implemented:

- `Cost231PropagationLossModel`
- `FixedRssLossModel`
- `FriisPropagationLossModel`
- `ItuR1411LosPropagationLossModel`
- `ItuR1411NlosOverRooftopPropagationLossModel`
- `JakesPropagationLossModel`
- `Kun2600MhzPropagationLossModel`
- `LogDistancePropagationLossModel`
- `MatrixPropagationLossModel`
- `NakagamiPropagationLossModel`
- `OkumuraHataPropagationLossModel`
- `RandomPropagationLossModel`
- `RangePropagationLossModel`
- `ThreeLogDistancePropagationLossModel`
- `TwoRayGroundPropagationLossModel`
- `ThreeGppPropagationLossModel`
  - `ThreeGppRMaPropagationLossModel`
  - `ThreeGppUMaPropagationLossModel`

- ThreeGppUmiStreetCanyonPropagationLossModel
- ThreeGppIndoorOfficePropagationLossModel

Other models could be available thanks to other modules, e.g., the `building` module.

Each of the available propagation loss models of ns-3 is explained in one of the following subsections.

### 28.1.1 FriisPropagationLossModel

This model implements the Friis propagation loss model. This model was first described in [friis]. The original equation was described as:

$$\frac{P_r}{P_t} = \frac{A_r A_t}{d^2 \lambda^2}$$

with the following equation for the case of an isotropic antenna with no heat loss:

$$A_{isotr.} = \frac{\lambda^2}{4\pi}$$

The final equation becomes:

$$\frac{P_r}{P_t} = \frac{\lambda^2}{(4\pi d)^2}$$

Modern extensions to this original equation are:

$$P_r = \frac{P_t G_t G_r \lambda^2}{(4\pi d)^2 L}$$

With:

$P_t$  : transmission power (W)

$P_r$  : reception power (W)

$G_t$  : transmission gain (unit-less)

$G_r$  : reception gain (unit-less)

$\lambda$  : wavelength (m)

$d$  : distance (m)

$L$  : system loss (unit-less)

In the implementation,  $\lambda$  is calculated as  $\frac{C}{f}$ , where  $C = 299792458$  m/s is the speed of light in vacuum, and  $f$  is the frequency in Hz which can be configured by the user via the Frequency attribute.

The Friis model is valid only for propagation in free space within the so-called far field region, which can be considered approximately as the region for  $d > 3\lambda$ . The model will still return a value for  $d < 3\lambda$ , as doing so (rather than triggering a fatal error) is practical for many simulation scenarios. However, we stress that the values obtained in such conditions shall not be considered realistic.

Related with this issue, we note that the Friis formula is undefined for  $d = 0$ , and results in  $P_r > P_t$  for  $d < \lambda/2\sqrt{\pi}$ .

Both these conditions occur outside of the far field region, so in principle the Friis model shall not be used in these conditions. In practice, however, Friis is often used in scenarios where accurate propagation modeling is not deemed important, and values of  $d = 0$  can occur.

To allow practical use of the model in such scenarios, we have to 1) return some value for  $d = 0$ , and 2) avoid large discontinuities in propagation loss values (which could lead to artifacts such as bogus capture effects which are much

worse than inaccurate propagation loss values). The two issues are conflicting, as, according to the Friis formula,  $\lim_{d \rightarrow 0} P_r = +\infty$ ; so if, for  $d = 0$ , we use a fixed loss value, we end up with an infinitely large discontinuity, which as we discussed can cause undesirable simulation artifacts.

To avoid these artifact, this implementation of the Friis model provides an attribute called `MinLoss` which allows to specify the minimum total loss (in dB) returned by the model. This is used in such a way that  $P_r$  continuously increases for  $d \rightarrow 0$ , until `MinLoss` is reached, and then stay constant; this allow to return a value for  $d = 0$  and at the same time avoid discontinuities. The model won't be much realistic, but at least the simulation artifacts discussed before are avoided. The default value of `MinLoss` is 0 dB, which means that by default the model will return  $P_r = P_t$  for  $d \leq \lambda/2\sqrt{\pi}$ . We note that this value of  $d$  is outside of the far field region, hence the validity of the model in the far field region is not affected.

### 28.1.2 TwoRayGroundPropagationLossModel

This model implements a Two-Ray Ground propagation loss model ported from NS2

The Two-ray ground reflection model uses the formula

$$P_r = \frac{P_t * G_t * G_r * (H_t^2 * H_r^2)}{d^4 * L}$$

The original equation in Rappaport's book assumes  $L = 1$ . To be consistent with the free space equation,  $L$  is added here.

$H_t$  and  $H_r$  are set at the respective nodes  $z$  coordinate plus a model parameter set via `SetHeightAboveZ`.

The two-ray model does not give a good result for short distances, due to the oscillation caused by constructive and destructive combination of the two rays. Instead the Friis free-space model is used for small distances.

The crossover distance, below which Friis is used, is calculated as follows:

$$d_{Cross} = \frac{(4 * \pi * H_t * H_r)}{\lambda}$$

In the implementation,  $\lambda$  is calculated as  $\frac{C}{f}$ , where  $C = 299792458$  m/s is the speed of light in vacuum, and  $f$  is the frequency in Hz which can be configured by the user via the `Frequency` attribute.

### 28.1.3 LogDistancePropagationLossModel

This model implements a log distance propagation model.

The reception power is calculated with a so-called log-distance propagation model:

$$L = L_0 + 10n \log\left(\frac{d}{d_0}\right)$$

where:

$n$  : the path loss distance exponent

$d_0$  : reference distance (m)

$L_0$  : path loss at reference distance (dB)

$d$  : - distance (m)

$L$  : path loss (dB)

When the path loss is requested at a distance smaller than the reference distance, the tx power is returned.

### 28.1.4 ThreeLogDistancePropagationLossModel

This model implements a log distance path loss propagation model with three distance fields. This model is the same as ns3::LogDistancePropagationLossModel except that it has three distance fields: near, middle and far with different exponents.

Within each field the reception power is calculated using the log-distance propagation equation:

$$L = L_0 + 10 \cdot n_0 \log_{10}\left(\frac{d}{d_0}\right)$$

Each field begins where the previous ends and all together form a continuous function.

There are three valid distance fields: near, middle, far. Actually four: the first from 0 to the reference distance is invalid and returns txPowerDbm.

$$\underbrace{0 \dots\dots d_0}_{=0} \underbrace{\dots\dots d_1}_{n_0} \underbrace{\dots\dots d_2}_{n_1} \underbrace{\dots\dots \infty}_{n_2}$$

Complete formula for the path loss in dB:

$$L = \begin{cases} 0 & d < d_0 \\ L_0 + 10 \cdot n_0 \log_{10}\left(\frac{d}{d_0}\right) & d_0 \leq d < d_1 \\ L_0 + 10 \cdot n_0 \log_{10}\left(\frac{d_1}{d_0}\right) + 10 \cdot n_1 \log_{10}\left(\frac{d}{d_1}\right) & d_1 \leq d < d_2 \\ L_0 + 10 \cdot n_0 \log_{10}\left(\frac{d_1}{d_0}\right) + 10 \cdot n_1 \log_{10}\left(\frac{d_2}{d_1}\right) + 10 \cdot n_2 \log_{10}\left(\frac{d}{d_2}\right) & d_2 \leq d \end{cases}$$

where:

- $d_0, d_1, d_2$  : three distance fields (m)
- $n_0, n_1, n_2$  : path loss distance exponent for each field (unitless)
- $L_0$  : path loss at reference distance (dB)
- $d$  : - distance (m)
- $L$  : path loss (dB)

When the path loss is requested at a distance smaller than the reference distance  $d_0$ , the tx power (with no path loss) is returned. The reference distance defaults to 1m and reference loss defaults to FriisPropagationLossModel with 5.15 GHz and is thus  $L_0 = 46.67$  dB.

### 28.1.5 JakesPropagationLossModel

ToDo

### 28.1.6 RandomPropagationLossModel

The propagation loss is totally random, and it changes each time the model is called. As a consequence, all the packets (even those between two fixed nodes) experience a random propagation loss.

### 28.1.7 NakagamiPropagationLossModel

This propagation loss model implements the Nakagami-m fast fading model, which accounts for the variations in signal strength due to multipath fading. The model does not account for the path loss due to the distance traveled by the signal, hence for typical simulation usage it is recommended to consider using it in combination with other models that take into account this aspect.



The Nakagami-m distribution is applied to the power level. The probability density function is defined as

$$p(x; m, \omega) = \frac{2m^m}{\Gamma(m)\omega^m} x^{2m-1} e^{-\frac{m}{\omega}x^2}$$

with  $m$  the fading depth parameter and  $\omega$  the average received power.

It is implemented by either a `GammaRandomVariable` or a `ErlangRandomVariable` random variable.

The implementation of the model allows to specify different values of the  $m$  parameter (and hence different fast fading profiles) for three different distance ranges:

$$\underbrace{0 \dots \dots d_1}_{m_0} \underbrace{\dots \dots d_2}_{m_1} \underbrace{\dots \dots \infty}_{m_2}$$

For  $m = 1$  the Nakagami-m distribution equals the Rayleigh distribution. Thus this model also implements Rayleigh distribution based fast fading.

### 28.1.8 FixedRssLossModel

This model sets a constant received power level independent of the transmit power.

The received power is constant independent of the transmit power; the user must set received power level. Note that if this loss model is chained to other loss models, it should be the first loss model in the chain. Else it will disregard the losses computed by loss models that precede it in the chain.

### 28.1.9 MatrixPropagationLossModel

The propagation loss is fixed for each pair of nodes and doesn't depend on their actual positions. This model should be useful for synthetic tests. Note that by default the propagation loss is assumed to be symmetric.

### 28.1.10 RangePropagationLossModel

This propagation loss depends only on the distance (range) between transmitter and receiver.

The single `MaxRange` attribute (units of meters) determines path loss. Receivers at or within `MaxRange` meters receive the transmission at the transmit power level. Receivers beyond `MaxRange` receive at power -1000 dBm (effectively zero).

### 28.1.11 OkumuraHataPropagationLossModel

This model is used to model open area pathloss for long distance (i.e., > 1 Km). In order to include all the possible frequencies usable by LTE we need to consider several variants of the well known Okumura Hata model. In fact, the original Okumura Hata model [hata] is designed for frequencies ranging from 150 MHz to 1500 MHz, the COST231 [cost231] extends it for the frequency range from 1500 MHz to 2000 MHz. Another important aspect is the scenarios considered by the models, in fact the all models are originally designed for urban scenario and then only the standard one and the COST231 are extended to suburban, while only the standard one has been extended to open areas. Therefore, the model cannot cover all scenarios at all frequencies. In the following we detail the models adopted.

The pathloss expression of the COST231 OH is:

$$L = 46.3 + 33.9 \log f - 13.82 \log h_b + (44.9 - 6.55 \log h_b) \log d - F(h_M) + C$$

where

$$F(h_M) = \begin{cases} (1.1 \log(f)) - 0.7 \times h_M - (1.56 \times \log(f) - 0.8) & \text{for medium and small size cities} \\ 3.2 \times (\log(11.75 \times h_M))^2 & \text{for large cities} \end{cases}$$

$$C = \begin{cases} 0dB & \text{for medium-size cities and suburban areas} \\ 3dB & \text{for large cities} \end{cases}$$

and

$f$  : frequency [MHz]

$h_b$  : eNB height above the ground [m]

$h_M$  : UE height above the ground [m]

$d$  : distance [km]

$\log$  : is a logarithm in base 10 (this for the whole document)

This model is only for urban scenarios.

The pathloss expression of the standard OH in urban area is:

$$L = 69.55 + 26.16 \log f - 13.82 \log h_b + (44.9 - 6.55 \log h_b) \log d - C_H$$

where for small or medium sized city

$$C_H = 0.8 + (1.1 \log f - 0.7)h_M - 1.56 \log f$$

and for large cities

$$C_H = \begin{cases} 8.29(\log(1.54h_M))^2 - 1.1 & \text{if } 150 \leq f \leq 200 \\ 3.2(\log(11.75h_M))^2 - 4.97 & \text{if } 200 < f \leq 1500 \end{cases}$$

There extension for the standard OH in suburban is

$$L_{SU} = L_U - 2 \left( \log \frac{f}{28} \right)^2 - 5.4$$

where

$L_U$  : pathloss in urban areas

The extension for the standard OH in open area is

$$L_O = L_U - 4.70(\log f)^2 + 18.33 \log f - 40.94$$

The literature lacks of extensions of the COST231 to open area (for suburban it seems that we can just impose  $C = 0$ ); therefore we consider it a special case for the suburban one.

### 28.1.12 Cost231PropagationLossModel

ToDo

### 28.1.13 ItuR1411LosPropagationLossModel

This model is designed for Line-of-Sight (LoS) short range outdoor communication in the frequency range 300 MHz to 100 GHz. This model provides an upper and lower bound respectively according to the following formulas

$$L_{LoS,l} = L_{bp} + \begin{cases} 20 \log \frac{d}{R_{bp}} & \text{for } d \leq R_{bp} \\ 40 \log \frac{d}{R_{bp}} & \text{for } d > R_{bp} \end{cases}$$

$$L_{LoS,u} = L_{bp} + 20 + \begin{cases} 25 \log \frac{d}{R_{bp}} & \text{for } d \leq R_{bp} \\ 40 \log \frac{d}{R_{bp}} & \text{for } d > R_{bp} \end{cases}$$

where the breakpoint distance is given by

$$R_{bp} \approx \frac{4h_b h_m}{\lambda}$$

and the above parameters are

$\lambda$  : wavelength [m]

$h_b$  : eNB height above the ground [m]

$h_m$  : UE height above the ground [m]

$d$  : distance [m]

and  $L_{bp}$  is the value for the basic transmission loss at the break point, defined as:

$$L_{bp} = \left| 20 \log \left( \frac{\lambda^2}{8\pi h_b h_m} \right) \right|$$

The value used by the simulator is the average one for modeling the median pathloss.

### 28.1.14 ItuR1411NlosOverRooftopPropagationLossModel

This model is designed for Non-Line-of-Sight (LoS) short range outdoor communication over rooftops in the frequency range 300 MHz to 100 GHz. This model includes several scenario-dependent parameters, such as average street width, orientation, etc. It is advised to set the values of these parameters manually (using the ns-3 attribute system) according to the desired scenario.

In detail, the model is based on [walfisch] and [ikegami], where the loss is expressed as the sum of free-space loss ( $L_{bf}$ ), the diffraction loss from rooftop to street ( $L_{rts}$ ) and the reduction due to multiple screen diffraction past rows of building ( $L_{msd}$ ). The formula is:

$$L_{NLOS1} = \begin{cases} L_{bf} + L_{rts} + L_{msd} & \text{for } L_{rts} + L_{msd} > 0 \\ L_{bf} & \text{for } L_{rts} + L_{msd} \leq 0 \end{cases}$$

The free-space loss is given by:

$$L_{bf} = 32.4 + 20 \log(d/1000) + 20 \log(f)$$

where:

$f$  : frequency [MHz]

$d$  : distance (where  $d > 1$ ) [m]

The term  $L_{rts}$  takes into account the width of the street and its orientation, according to the formulas

$$L_{rts} = -8.2 - 10 \log(w) + 10 \log(f) + 20 \log(\Delta h_m) + L_{ori}$$

$$L_{ori} = \begin{cases} -10 + 0.354\varphi & \text{for } 0^\circ \leq \varphi < 35^\circ \\ 2.5 + 0.075(\varphi - 35) & \text{for } 35^\circ \leq \varphi < 55^\circ \\ 4.0 - 0.114(\varphi - 55) & \text{for } 55^\circ \leq \varphi \leq 90^\circ \end{cases}$$

$$\Delta h_m = h_r - h_m$$

where:

$h_r$  : is the height of the rooftop [m]

$h_m$  : is the height of the mobile [m]

$\varphi$  : is the street orientation with respect to the direct path (degrees)

The multiple screen diffraction loss depends on the BS antenna height relative to the building height and on the incidence angle. The former is selected as the higher antenna in the communication link. Regarding the latter, the “settled field distance” is used for select the proper model; its value is given by

$$d_s = \frac{\lambda d^2}{\Delta h_b^2}$$

with

$$\Delta h_b = h_b - h_m$$

Therefore, in case of  $l > d_s$  (where  $l$  is the distance over which the building extend), it can be evaluated according to

$$L_{msd} = L_{bsh} + k_a + k_d \log(d/1000) + k_f \log(f) - 9 \log(b)$$

$$L_{bsh} = \begin{cases} -18 \log(1 + \Delta h_b) & \text{for } h_b > h_r \\ 0 & \text{for } h_b \leq h_r \end{cases}$$

$$k_a = \begin{cases} 71.4 & \text{for } h_b > h_r \text{ and } f > 2000 \text{ MHz} \\ 54 & \text{for } h_b > h_r \text{ and } f \leq 2000 \text{ MHz} \\ 54 - 0.8\Delta h_b & \text{for } h_b \leq h_r \text{ and } d \geq 500 \text{ m} \\ 54 - 1.6\Delta h_b & \text{for } h_b \leq h_r \text{ and } d < 500 \text{ m} \end{cases}$$

$$k_d = \begin{cases} 18 & \text{for } h_b > h_r \\ 18 - 15 \frac{\Delta h_b}{h_r} & \text{for } h_b \leq h_r \end{cases}$$

$$k_f = \begin{cases} -8 & \text{for } f > 2000 \text{ MHz} \\ -4 + 0.7(f/925 - 1) & \text{for medium city and suburban centres and } f \leq 2000 \text{ MHz} \\ -4 + 1.5(f/925 - 1) & \text{for metropolitan centres and } f \leq 2000 \text{ MHz} \end{cases}$$

Alternatively, in case of  $l < d_s$ , the formula is:

$$L_{msd} = -10 \log(Q_M^2)$$

where

$$Q_M = \begin{cases} 2.35 \left( \frac{\Delta h_b}{d} \sqrt{\frac{b}{\lambda}} \right)^{0.9} & \text{for } h_b > h_r \\ \frac{b}{d} & \text{for } h_b \approx h_r \\ \frac{b}{2\pi d} \sqrt{\frac{\lambda}{\rho}} \left( \frac{1}{\theta} - \frac{1}{2\pi + \theta} \right) & \text{for } h_b < h_r \end{cases}$$

where:

$$\theta = \arctan\left(\frac{\Delta h_b}{b}\right)$$

$$\rho = \sqrt{\Delta h_b^2 + b^2}$$

### 28.1.15 Kun2600MhzPropagationLossModel

This is the empirical model for the pathloss at 2600 MHz for urban areas which is described in [kun2600mhz]. The model is as follows. Let  $d$  be the distance between the transmitter and the receiver in meters; the pathloss  $L$  in dB is calculated as:

$$L = 36 + 26 \log d$$

## 28.1.16 ThreeGppPropagationLossModel

The base class `ThreeGppPropagationLossModel` and its derived classes implement the path loss and shadow fading models described in 3GPP TR 38.901<sup>38901</sup>. 3GPP TR 38.901 includes multiple scenarios modeling different propagation environments, i.e., indoor, outdoor urban and rural, for frequencies between 0.5 and 100 GHz.

*Implemented features:*

- Path loss and shadowing models (3GPP TR 38.901, Sec. 7.4.1)
- Autocorrelation of shadow fading (3GPP TR 38.901, Sec. 7.4.4)
- Channel condition models (3GPP TR 38.901, Sec. 7.4.2)

*To be implemented:*

- O2I penetration loss (3GPP TR 38.901, Sec. 7.4.3)
- Spatial consistent update of the channel states (3GPP TR 38.901 Sec. 7.6.3.3)

### Configuration

The `ThreeGppPropagationLossModel` instance is paired with a `ChannelConditionModel` instance used to retrieve the LOS/NLOS channel condition. By default, a 3GPP channel condition model related to the same scenario is set (e.g., by default, `ThreeGppRmaPropagationLossModel` is paired with `ThreeGppRmaChannelConditionModel`), but it can be configured using the method `SetChannelConditionModel`. The channel condition models are stored inside the `propagation` module, for a limitation of the current spectrum API and to avoid a circular dependency between the spectrum and the `propagation` modules. Please note that it is necessary to install at least one `ChannelConditionModel` when using any `ThreeGppPropagationLossModel` subclass. Please look below for more information about the Channel Condition models.

The operating frequency has to be set using the attribute “Frequency”, otherwise an assert is raised. The addition of the shadow fading component can be enabled/disabled through the attribute “ShadowingEnabled”. Other scenario-related parameters can be configured through attributes of the derived classes.

### Implementation details

The method `DoCalcRxPower` computes the propagation loss considering the path loss and the shadow fading (if enabled). The path loss is computed by the method `GetLossLos` or `GetLossNlos` depending on the LOS/NLOS channel condition, and their implementation is left to the derived classes. The shadow fading is computed by the method `GetShadowing`, which generates an additional random loss component characterized by Gaussian distribution with zero mean and scenario-specific standard deviation. Subsequent shadowing components of each BS-UT link are correlated as described in 3GPP TR 38.901, Sec. 7.4.4<sup>38901</sup>.

*Note 1:* The TR defines height ranges for UTs and BSs, depending on the chosen propagation model (for the exact values, please see below in the specific model documentation). If the user does not set correct values, the model will emit a warning but perform the calculation anyway.

*Note 2:* The 3GPP model is originally intended to be used to represent BS-UT links. However, in ns-3, we may need to compute the pathloss between two BSs or UTs to evaluate the interference. We have decided to support this case by considering the tallest node as a BS and the smallest as a UT. As a consequence, the height values may be outside the validity range of the chosen class: therefore, an inaccuracy warning may be printed, but it can be ignored.

There are four derived class, each one implementing the propagation model for a different scenario:

### ThreeGppRmaPropagationLossModel

This class implements the LOS/NLOS path loss and shadow fading models described in 3GPP TR 38.901<sup>38901</sup>, Table 7.4.1-1 for the RMa scenario. It supports frequencies between 0.5 and 30 GHz. It is possible to configure some

<sup>38901</sup> 3GPP. 2018. TR 38.901, Study on channel model for frequencies from 0.5 to 100 GHz, V15.0.0. (2018-06).

scenario-related parameters through the attributes `AvgBuildingHeight` and `AvgStreetWidth`.

As specified in the TR, the 2D distance between the transmitter and the receiver should be between 10 m and 10 km for the LOS case, or between 10 m and 5 km for the NLOS case, otherwise the model may not be accurate (a warning message is printed if the user has enabled logging on the model). Also, the height of the base station (hBS) should be between 10 m and 150 m, while the height of the user terminal (hUT) should be between 1 m and 10 m.

### **ThreeGppUMaPropagationLossModel**

This implements the LOS/NLOS path loss and shadow fading models described in 3GPP TR 38.901<sup>38901</sup>, Table 7.4.1-1 for the UMa scenario. It supports frequencies between 0.5 and 100 GHz.

As specified in the TR, the 2D distance between the transmitter and the receiver should be between 10 m and 5 km both for the LOS and NLOS cases, otherwise the model may not be accurate (a warning message is printed if the user has enabled logging on the model). Also, the height of the base station (hBS) should be 25 m and the height of the user terminal (hUT) should be between 1.5 m and 22.5 m.

### **ThreeGppUmiStreetCanyonPropagationLossModel**

This implements the LOS/NLOS path loss and shadow fading models described in 3GPP TR 38.901<sup>38901</sup>, Table 7.4.1-1 for the UMi-Street Canyon scenario. It supports frequencies between 0.5 and 100 GHz.

As specified in the TR, the 2D distance between the transmitter and the receiver should be between 10 m and 5 km both for the LOS and NLOS cases, otherwise the model may not be accurate (a warning message is printed if the user has enabled logging on the model). Also, the height of the base station (hBS) should be 10 m and the height of the user terminal (hUT) should be between 1.5 m and 10 m (the validity range is reduced because we assume that the height of the UT nodes is always lower than the height of the BS nodes).

### **ThreeGppIndoorOfficePropagationLossModel**

This implements the LOS/NLOS path loss and shadow fading models described in 3GPP TR 38.901<sup>38901</sup>, Table 7.4.1-1 for the Indoor-Office scenario. It supports frequencies between 0.5 and 100 GHz.

As specified in the TR, the 3D distance between the transmitter and the receiver should be between 1 m and 150 m both for the LOS and NLOS cases, otherwise the model may not be accurate (a warning log message is printed if the user has enabled logging on the model).

## **Testing**

The test suite `ThreeGppPropagationLossModelsTestSuite` provides test cases for the classes implementing the 3GPP propagation loss models. The test cases `ThreeGppRmaPropagationLossModelTestCase`, `ThreeGppUmaPropagationLossModelTestCase`, `ThreeGppUmiPropagationLossModelTestCase` and `ThreeGppIndoorOfficePropagationLossModelTestCase` compute the path loss between two nodes and compares it with the value obtained using the formulas in 3GPP TR 38.901<sup>38901</sup>, Table 7.4.1-1. The test case `ThreeGppShadowingTestCase` checks if the shadowing is correctly computed by testing the deviation of the overall propagation loss from the path loss. The test is carried out for all the scenarios, both in LOS and NLOS condition.

## **28.2 ChannelConditionModel**

The loss models require to know if two nodes are in Line-of-Sight (LoS) or if they are not. The interface for that is represented by this class. The main method is `GetChannelCondition(a, b)`, which returns a `ChannelCondition`

object containing the information about the channel state.

We modeled the LoS condition in two ways: (i) by using a probabilistic model specified by the 3GPP (), and (ii) by using an ns-3 specific building-aware model, which checks the space position of the BSs and the UTs. For what regards the first option, the probability is independent of the node location: in other words, following the 3GPP model, two UT spatially separated by an epsilon may have different LoS conditions. To take into account mobility, we have inserted a parameter called “UpdatePeriod,” which indicates how often a 3GPP-based channel condition has to be updated. By default, this attribute is set to 0, meaning that after the channel condition is generated, it is never updated. With this default value, we encourage the users to run multiple simulations with different seeds to get statistical significance from the data. For the users interested in using mobile nodes, we suggest changing this parameter to a value that takes into account the node speed and the desired accuracy. For example, lower-speed node conditions may be updated in terms of seconds, while high-speed UT or BS may be updated more often.

The two approach are coded, respectively, in the classes:

- `ThreeGppChannelConditionModel`
- `BuildingsChannelConditionModel` (see the building module documentation for further details)

### 28.2.1 ThreeGppChannelConditionModel

This is the base class for the 3GPP channel condition models. It provides the possibility to updated the condition of each channel periodically, after a given time period which can be configured through the attribute “UpdatePeriod”. If “UpdatePeriod” is set to 0, the channel condition is never updated. It has five derived classes implementing the channel condition models described in 3GPP TR 38.901<sup>38901</sup> for different propagation scenarios.

#### ThreeGppRmaChannelConditionModel

This implements the statistical channel condition model described in 3GPP TR 38.901<sup>38901</sup>, Table 7.4.2-1, for the RMa scenario.

#### ThreeGppUmaChannelConditionModel

This implements the statistical channel condition model described in 3GPP TR 38.901<sup>38901</sup>, Table 7.4.2-1, for the UMa scenario.

#### ThreeGppUmiStreetCanyonChannelConditionModel

This implements the statistical channel condition model described in 3GPP TR 38.901<sup>38901</sup>, Table 7.4.2-1, for the UMi-Street Canyon scenario.

#### ThreeGppIndoorMixedOfficeChannelConditionModel

This implements the statistical channel condition model described in 3GPP TR 38.901<sup>38901</sup>, Table 7.4.2-1, for the Indoor-Mixed office scenario.

#### ThreeGppIndoorOpenOfficeChannelConditionModel

This implements the statistical channel condition model described in 3GPP TR 38.901<sup>38901</sup>, Table 7.4.2-1, for the Indoor-Open office scenario.

## 28.2.2 Testing

The test suite `ChannelConditionModelsTestSuite` contains a single test case:

- `ThreeGppChannelConditionModelTestCase`, which tests all the 3GPP channel condition models. It determines the channel condition between two nodes multiple times, estimates the LOS probability, and compares it with the value given by the formulas in 3GPP TR 38.901<sup>38901</sup>, Table 7.4.2-1

## 28.3 PropagationDelayModel

The following propagation delay models are implemented:

- `ConstantSpeedPropagationDelayModel`
- `RandomPropagationDelayModel`

### 28.3.1 ConstantSpeedPropagationDelayModel

In this model, the signal travels with constant speed. The delay is calculated according with the transmitter and receiver positions. The Euclidean distance between the Tx and Rx antennas is used. Beware that, according to this model, the Earth is flat.

### 28.3.2 RandomPropagationDelayModel

The propagation delay is totally random, and it changes each time the model is called. All the packets (even those between two fixed nodes) experience a random delay. As a consequence, the packets order is not preserved.

## 28.4 Models for vehicular environments

The 3GPP TR 37.885<sup>37885</sup> specifications extends the channel modeling framework described in TR 38.901<sup>38901</sup> to simulate wireless channels in vehicular environments. The extended framework supports frequencies between 0.5 to 100 GHz and provides the possibility to simulate urban and highway propagation environments. To do so, new propagation loss and channel condition models, as well as new parameters for the fast fading model, are provided.

### 28.4.1 Vehicular channel condition models

To properly capture channel dynamics in vehicular environments, three different channel conditions have been identified:

- LOS (Line Of Sight): represents the case in which the direct path between the transmitter and the receiver is not blocked
- NLOS<sub>v</sub> (Non Line Of Sight vehicle): when the direct path between the transmitter and the receiver is blocked by a vehicle
- NLOS (Non Line Of Sight): when the direct path is blocked by a building

<sup>37885</sup> 3GPP. 2019. TR 37.885, Study on evaluation methodology of new Vehicle-to-Everything (V2X) use cases for LTE and NR, V15.3.0. (2019-06).



TR 37.885 includes two models that can be used to determine the condition of the wireless channel between a pair of nodes, the first for urban and the second for highway environments. Each model includes both a deterministic and a stochastic part, and works as follows.

1. The model determines the presence of buildings obstructing the direct path between the communicating nodes. This is done in a deterministic way, looking at the possible interceptions between the direct path and the buildings. If the path is obstructed, the channel condition is set to NLOS.
2. If not, the model determines the presence of vehicles obstructing the direct path. This is done using a probabilistic model, which is specific for the scenario of interest. If the path is obstructed, the channel condition is set to NLOSv, otherwise is set to LOS.

These models have been implemented by extending the interface `ChannelConditionModel` with the following classes. They have been included in the `building` module, because they make use of `Buildings` objects to determine the presence of obstructions caused by buildings.

- `ThreeGppV2vUrbanChannelConditionModel`: implements the model described in Table 6.2-1 of TR 37.885 for the urban scenario.
- `ThreeGppV2vHighwayChannelConditionModel`: implements the model described in Table 6.2-1 of TR 37.885 for the highway scenario.

These models rely on `Buildings` objects to determine the presence of obstructing buildings. When considering large scenarios with a large number of buildings, this process may become computationally demanding and dramatically increase the simulation time. To solve this problem, we implemented two fully-probabilistic models that can be used as an alternative to the ones included in TR 37.885. These models are based on the work carried out by M. Boban et al. [[Boban2016Modeling](#)], which derived a statistical representation of the three channel conditions. With the fully-probabilistic models there is no need to determine the presence of blocking buildings in a deterministic way, and therefore the computational effort is reduced. To determine the channel condition, these models account for the propagation environment, i.e., urban or highway, as well as for the density of vehicles in the scenario, which can be high, medium, or low.

**The classes implementing the fully-probabilistic models are:**

- `ProbabilisticV2vUrbanChannelConditionModel`: implements the model described in [[Boban2016Modeling](#)] for the urban scenario.
- `ProbabilisticV2vHighwayChannelConditionModel`: implements the model described in [[Boban2016Modeling](#)] for the highway scenario.

Both the classes own the attribute “Density”, which can be used to select the proper value depending on the scenario that have to be simulated. Differently from the hybrid models described above, these classes have been included in the `propagation` module, since they do not have any dependency on the `building` module.

**NOTE:** Both the hybrid and the fully-probabilistic models supports the modeling of outdoor scenarios, no support is provided for the modeling of indoor scenarios.

## 28.4.2 Vehicular propagation loss models

The propagation models described in TR 37.885 determines the attenuation caused by path loss and shadowing by considering the propagation environment and the channel condition.

These models have been implemented by extending the interface `ThreeGppPropagationLossModel` with the following classes, which are part of the `propagation` module:

- `ThreeGppV2vUrbanPropagationLossModel`: implements the models defined in Table 6.2.1-1 of TR 37.885 for the urban scenario.
- `ThreeGppV2vHighwayPropagationLossModel`: implements the models defined in Table 6.2.1-1 of TR 37.885 for the highway scenario.

As for all the classes extending the interface `ThreeGppPropagationLossModel`, they have to be paired with an instance of the class `ChannelConditionModel` which is used to determine the channel condition. This is done by setting the attribute `ChannelConditionModel`. To build the channel modeling framework described in TR 37.885, `ThreeGppV2vUrbanChannelConditionModel` or `ThreeGppV2vHighwayChannelConditionModel` should be used, but users are allowed to test any other combination.

### 28.4.3 Vehicular fast fading model

The fast fading model described in Sec. 6.2.3 of TR 37.885 is based on the one specified in TR 38.901, whose implementation is provided in the `spectrum` module (see the *spectrum module documentation*). This model is general and includes different parameters which can be tuned to simulate multiple propagation environments. To better model the channel dynamics in vehicular environments, TR 37.885 provides new sets of values for these parameters, specific for vehicle-to-vehicle transmissions in urban and highway scenarios. To select the parameters for vehicular scenarios, it is necessary to set the attribute “Scenario” of the class `ThreeGppChannelModel` using the value “V2V-Urban” or “V2V-Highway”.

Additionally, TR 37.885 specifies a new equation to compute the Doppler component, which accounts for the mobility of both nodes, as well as scattering from the environment. In particular, the scattering effect is considered by deviating the Doppler frequency by a random value, whose distribution depends on the parameter  $v_{scatt}$ . TR 37.885 specifies that  $v_{scatt}$  should be set to the maximum speed of the vehicles in the layout and, if  $v_{scatt} = 0$ , the scattering effect is not considered. The Doppler equation is implemented in the class `ThreeGppSpectrumPropagationLossModel`. By means of the attribute “vScatt”, it is possible to adjust the value of  $v_{scatt} = 0$  (by default, the value is set to 0).

### 28.4.4 Example

We implemented the example `three-gpp-v2v-channel-example.cc` which shows how to configure the different classes to simulate wireless propagation in vehicular scenarios, it can be found in the folder `examples/channel-models`.

We considered two communicating vehicles moving within the scenario, and computed the SNR experienced during the entire simulation, with a time resolution of 10 ms. The vehicles are equipped with 2x2 antenna arrays modeled using the *3GPP antenna model*. The bearing and the downtilt angles are properly configured and the optimal beam-forming vectors are computed at the beginning of the simulation.

**The simulation script accepts the following command line parameters:**

- *frequency*: the operating frequency in Hz
- *txPow*: the transmission power in dBm
- *noiseFigure*: the noise figure in dB
- *scenario*: the simulation scenario, “V2V-Urban” or “V2V-Highway”

The “V2V-Urban” scenario simulates urban environment with a rectangular grid of buildings. The vehicles moves with a waypoint mobility model. They start from the same position and travel in the same direction, along the main street. The first vehicle moves at 60 km/h and the second at 30 km/h. At a certain point, the first vehicle turns left while the second continues on the main street.

The “V2V-Highway” scenario simulates an highway environment in which the two vehicles travel on the same lane, in the same direction, and keep a safety distance of 20 m. They maintain a constant speed of 140 km/h.

The example generates the output file `example-output.txt`. Each row of the file is organized as follows:

```
Time[s] TxPosX[m] TxPosY[m] RxPosX[m] RxPosY[m] ChannelState SNR[dB] Pathloss[dB]
```

We also provide the bash script `three-gpp-v2v-channel-example.sh` which reads the output file and generates two figures:

1. map.gif, a GIF representing the simulation scenario and vehicle mobility;
2. snr.png, which represents the behavior of the SNR.

## 28.5 References



## SPECTRUM MODULE

The Spectrum module aims at providing support for modeling the frequency-dependent aspects of communications in *ns-3*. The model was first introduced in [Baldo2009Spectrum], and has been enhanced and refined over the years.

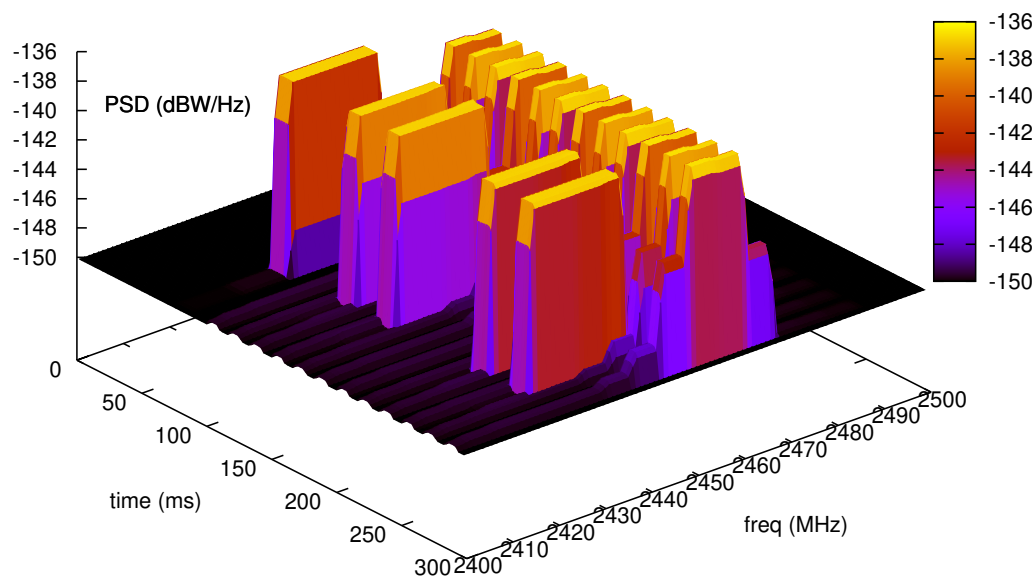

Fig. 1: Spectrogram produced by a spectrum analyzer in a scenario involving wifi signals interfered by a microwave oven, as simulated by the example `adhoc-aloha-ideal-phy-with-microwave-oven`.

### 29.1 Model Description

The module provides:

- a set of classes for modeling signals and
- a Channel/PHY interface based on a power spectral density signal representation that is technology-independent
- two technology-independent Channel implementations based on the Channel/PHY interface

- a set of basic PHY model implementations based on the Channel/PHY interface

The source code for the spectrum module is located at `src/spectrum`.

## 29.1.1 Design

### Signal model

The signal model is implemented by the `SpectrumSignalParameters` class. This class provides the following information for a signal being transmitted/received by PHY devices:

- a reference to the transmitting PHY device
- a reference to the antenna model used by the transmitting PHY device to transmit this signal
- the duration of the signal
- its Power Spectral Density (PSD) of the signal, which is assumed to be constant for the duration of the signal.

The PSD is represented as a set of discrete scalar values each corresponding to a certain subband in frequency. The set of frequency subbands to which the PSD refers to is defined by an instance of the `SpectrumModel` class. The PSD itself is implemented as an instance of the `SpectrumValue` class which contains a reference to the associated `SpectrumModel` class instance. The `SpectrumValue` class provides several arithmetic operators to allow to perform calculations with PSD instances. Additionally, the `SpectrumConverter` class provides means for the conversion of `SpectrumValue` instances from one `SpectrumModel` to another.

For a more formal mathematical description of the signal model just described, the reader is referred to [Baldo2009Spectrum].

The `SpectrumSignalParameters` class is meant to include only information that is valid for all signals; as such, it is not meant to be modified to add technology-specific information (such as type of modulation and coding schemes used, info on preambles and reference signals, etc). Instead, such information shall be put in a new class that inherits from `SpectrumSignalParameters` and extends it with any technology-specific information that is needed. This design is intended to model the fact that in the real world we have signals of different technologies being simultaneously transmitted and received over the air.

### Channel/PHY interface

The spectrum Channel/PHY interface is defined by the base classes `SpectrumChannel` and `SpectrumPhy`. Their interaction simulates the transmission and reception of signals over the medium. The way this interaction works is depicted in *Sequence diagram showing the interaction between SpectrumPhy and SpectrumChannel*:

### Spectrum Channel implementations

The module provides two `SpectrumChannel` implementations: `SingleModelSpectrumChannel` and `MultiModelSpectrumChannel`. They both provide this functionality:

- Propagation loss modeling, in two forms:
  - you can plug models based on `PropagationLossModel` on these channels. Only linear models (where the loss value does not depend on the transmission power) can be used. These models are single-frequency in the sense that the loss value is applied equally to all components of the power spectral density.
  - you can plug models based on `SpectrumPropagationLossModel` on these channels. These models can have frequency-dependent loss, i.e., a separate loss value is calculated and applied to each component of the power spectral density.

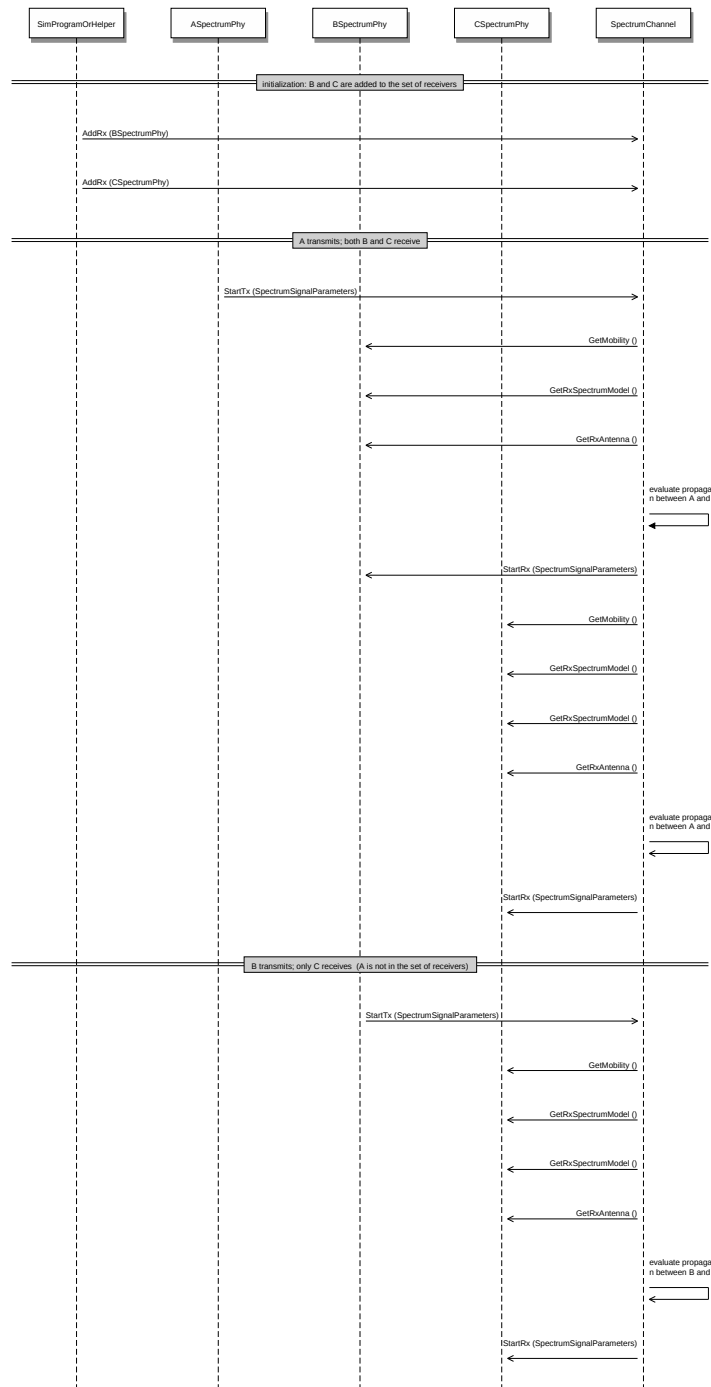

Fig. 2: Sequence diagram showing the interaction between SpectrumPhy and SpectrumChannel

- Propagation delay modeling, by plugging a model based on `PropagationDelayModel`. The delay is independent of frequency and applied to the signal as a whole. Delay modeling is implemented by scheduling the `StartRx` event with a delay respect to the `StartTx` event.

`SingleModelSpectrumChannel` and `MultiModelSpectrumChannel` are quite similar, the main difference is that `MultiModelSpectrumChannel` allows to use different `SpectrumModel` instances with the same channel instance, by automatically taking care of the conversion of PSDs among the different models.

### Example model implementations

The spectrum module provides some basic implementation of several components that are mainly intended as a proof-of-concept and as an example for building custom models with the spectrum module. Here is a brief list of the available implementations:

- `SpectrumModel300Khz300GhzLog` and `SpectrumModelIsm2400MhzRes1Mhz` are two example `SpectrumModel` implementations
- `HalfDuplexIdealPhy`: a basic PHY model using a gaussian interference model (implemented in `SpectrumInterference`) together with an error model based on Shannon capacity (described in [Baldo2009Spectrum] and implemented in `SpectrumErrorModel`). This PHY uses the `GenericPhy` interface. Its additional custom signal parameters are defined in `HalfDuplexIdealPhySignalParameters`.
- `WifiSpectrumValueHelper` is an helper object that makes it easy to create `SpectrumValues` representing PSDs and RF filters for the wifi technology.
- `AlohaNoackNetDevice`: a minimal `NetDevice` that allows to send packets over `HalfDuplexIdealPhy` (or other PHY model based on the `GenericPhy` interface).
- `SpectrumAnalyzer`, `WaveformGenerator` and `MicrowaveOven` are examples of PHY models other than communication devices - the names should be self-explaining.

### 29.1.2 References

## 29.2 Usage

The main use case of the spectrum model is for developers who want to develop a new model for the PHY layer of some wireless technology to be used within ns-3. Here are some notes on how the spectrum module is expected to be used.

- `SpectrumPhy` and `SpectrumChannel` are abstract base classes. Real code will use classes that inherit from these classes.
- If you are implementing a new model for some wireless technology of your interest, and want to use the spectrum module, you'll typically create your own module and make it depend on the spectrum module. Then you typically have to implement:
  - a child class of `SpectrumModel` which defines the (sets of) frequency subbands used by the considered wireless technology. **Note:** instances of `SpectrumModel` are typically statically allocated, in order to allow several `SpectrumValue` instances to reference the same `SpectrumModel` instance.
  - a child class of `SpectrumPhy` which will handle transmission and reception of signals (including, if appropriate, interference and error modeling).
  - a child class of `SpectrumSignalParameters` which will contain all the information needed to model the signals for the wireless technology being considered that is not already provided by the base `SpectrumSignalParameters` class. Examples of such information are the type of modulation and coding schemes used, the PHY preamble format, info on the pilot/reference signals, etc.



- The available `SpectrumChannel` implementations (`SingleModelSpectrumChannel` and `MultiModelSpectrumChannel`, are quite generic. Chances are you can use them as-is. Whether you prefer one or the other it is just a matter of whether you will have a single `SpectrumModel` or multiple ones in your simulations.
- Typically, there will be a single `SpectrumChannel` instance to which several `SpectrumPhy` instances are plugged. The rule of thumb is that all PHYs that are interfering with each other shall be plugged on the same channel. Multiple `SpectrumChannel` instances are expected to be used mainly when simulating completely orthogonal channels; for example, when simulating the uplink and downlink of a Frequency Division Duplex system, it is a good choice to use two `SpectrumChannel` instances in order to reduce computational complexity.
- Different types of `SpectrumPhy` (i.e., instances of different child classes) can be plugged on the same `SpectrumChannel` instance. This is one of the main features of the spectrum module, to support inter-technology interference. For example, if you implement a `WifiSpectrumPhy` and a `BluetoothSpectrumPhy`, and plug both on a `SpectrumChannel`, then you'll be able to simulate interference between wifi and bluetooth and vice versa.
- Different child classes of `SpectrumSignalParameters` can coexist in the same simulation, and be transmitted over the same channel object. Again, this is part of the support for inter-technology interference. A PHY device model is expected to use the `DynamicCast<>` operator to determine if a signal is of a certain type it can attempt to receive. If not, the signal is normally expected to be considered as interference.

### 29.2.1 Helpers

The helpers provided in `src/spectrum/helpers` are mainly intended for the example implementations described in *Example model implementations*. If you are developing your custom model based on the spectrum framework, you will probably prefer to define your own helpers.

### 29.2.2 Attributes

- Both `SingleModelSpectrumChannel` and `MultiModelSpectrumChannel` have an attribute `MaxLossDb` which can use to avoid propagating signals affected by very high propagation loss. You can use this to reduce the complexity of interference calculations. Just be careful to choose a value that does not make the interference calculations inaccurate.
- The example implementations described in *Example model implementations* also have several attributes.

### 29.2.3 Output

- Both `SingleModelSpectrumChannel` and `MultiModelSpectrumChannel` provide a trace source called `PathLoss` which is fired whenever a new path loss value is calculated. **Note:** only single-frequency path loss is accounted for, see the attribute description.
- The example implementations described in *Example model implementations* also provide some trace sources.
- The helper class `SpectrumAnalyzerHelper` can be conveniently used to generate an output text file containing the spectrogram produced by a `SpectrumAnalyzer` instance. The format is designed to be easily plotted with `gnuplot`. For example, if your run the example `adhoc-aloha-ideal-phy-with-microwave-oven` you will get an output file called `spectrum-analyzer-output-3-0.tr`. From this output file, you can generate a figure similar to *Spectrogram produced by a spectrum analyzer in a scenario involving wifi signals interfered by a microwave oven, as simulated by the example adhoc-aloha-ideal-phy-with-microwave-oven*. by executing the following `gnuplot` commands:

```
unset surface
set pm3d at s
set palette
set key off
set view 50,50
set xlabel "time (ms)"
set ylabel "freq (MHz)"
set zlabel "PSD (dBW/Hz)" offset 15,0,0
splot "./spectrum-analyzer-output-3-0.tr" using ($1*1000.0):($2/1e6):(10*log10($3))
```

## 29.2.4 Examples

The example programs in `src/spectrum/examples/` allow to see the example implementations described in *Example model implementations* in action.

## 29.2.5 Troubleshooting

- **Disclaimer on inter-technology interference:** the spectrum model makes it very easy to implement an inter-technology interference model, but this does not guarantee that the resulting model is accurate. For example, the gaussian interference model implemented in the `SpectrumInterference` class can be used to calculate inter-technology interference, however the results might not be valid in some scenarios, depending on the actual waveforms involved, the number of interferers, etc. Moreover, it is very important to use error models that are consistent with the interference model. The responsibility of ensuring that the models being used are correct is left to the user.

## 29.3 Testing

In this section we describe the test suites that are provided within the spectrum module.

### 29.3.1 SpectrumValue test

The test suite `spectrum-value` verifies the correct functionality of the arithmetic operators implemented by the `SpectrumValue` class. Each test case corresponds to a different operator. The test passes if the result provided by the operator implementation is equal to the reference values which were calculated offline by hand. Equality is verified within a tolerance of  $10^{-6}$  which is to account for numerical errors.

### 29.3.2 SpectrumConverter test

The test suite `spectrum-converter` verifies the correct functionality of the `SpectrumConverter` class. Different test cases correspond to the conversion of different `SpectrumValue` instances to different `SpectrumModel` instances. Each test passes if the `SpectrumValue` instance resulting from the conversion is equal to the reference values which were calculated offline by hand. Equality is verified within a tolerance of  $10^{-6}$  which is to account for numerical errors.

Describe how the model has been tested/validated. What tests run in the test suite? How much API and code is covered by the tests? Again, references to outside published work may help here.

### 29.3.3 Interference test

The test suite `spectrum-interference` verifies the correct functionality of the `SpectrumInterference` and `ShannonSpectrumErrorModel` in a scenario involving four signals (an intended signal plus three interferers). Different test cases are created corresponding to different PSDs of the intended signal and different amount of transmitted bytes. The test passes if the output of the error model (successful or failed) coincides with the expected one which was determine offline by manually calculating the achievable rate using Shannon's formula.

### 29.3.4 IdealPhy test

The test verifies that `AlohaNoackNetDevice` and `HalfDuplexIdealPhy` work properly when installed in a node. The test recreates a scenario with two nodes (a TX and a RX) affected by a path loss such that a certain SNR is obtained. The TX node transmits with a pre-determined PHY rate and with an application layer rate which is larger than the PHY rate, so as to saturate the channel. `PacketSocket` is used in order to avoid protocol overhead. Different test cases correspond to different PHY rate and SNR values. For each test case, we calculated offline (using Shannon's formula) whether the PHY rate is achievable or not. Each test case passes if the following conditions are satisfied:

- if the PHY rate is achievable, the application throughput shall be within 1% of the PHY rate;
- if the PHY rate is not achievable, the application throughput shall be zero.

## 29.4 Additional Models

### 29.4.1 TV Transmitter Model

A TV Transmitter model is implemented by the `TvSpectrumTransmitter` class. This model enables transmission of realistic TV signals to be simulated and can be used for interference modeling. It provides a customizable power spectral density (PSD) model, with configurable attributes including the type of modulation (with models for analog, 8-VSB, and COFDM), signal bandwidth, power spectral density level, frequency, and transmission duration. A helper class, `TvSpectrumTransmitterHelper`, is also provided to assist users in setting up simulations.

#### Main Model Class

The main TV Transmitter model class, `TvSpectrumTransmitter`, provides a user-configurable PSD model that can be transmitted on the `SpectrumChannel`. It inherits from `SpectrumPhy` and is comprised of attributes and methods to create and transmit the signal on the channel.

One of the user-configurable attributes is the type of modulation for the TV transmitter to use. The options are 8-VSB (Eight-Level Vestigial Sideband Modulation) which is notably used in the North America ATSC digital television standard, COFDM (Coded Orthogonal Frequency Division Multiplexing) which is notably used in the DVB-T and ISDB-T digital television standards adopted by various countries around the world, and analog modulation which is a legacy technology but is still being used by some countries today. To accomplish realistic PSD models for these modulation types, the signals' PSDs were approximated from real standards and developed into models that are scalable by frequency and power. The COFDM PSD is approximated from Figure 12 (8k mode) of [KoppCOFDM], the 8-VSB PSD is approximated from Figure 3 of [Baron8VSB], and the analog PSD is approximated from Figure 4 of [QualcommAnalog]. Note that the analog model is approximated from the NTSC standard, but other analog modulation standards such as PAL have similar signals. The approximated COFDM PSD model is in 8K mode. The other configurable attributes are the start frequency, signal/channel bandwidth, base PSD, antenna type, starting time, and transmit duration.

`TvSpectrumTransmitter` uses `IsotropicAntennaModel` as its antenna model by default, but any model that inherits from `AntennaModel` is selectable, so directional antenna models can also be used. The propagation loss

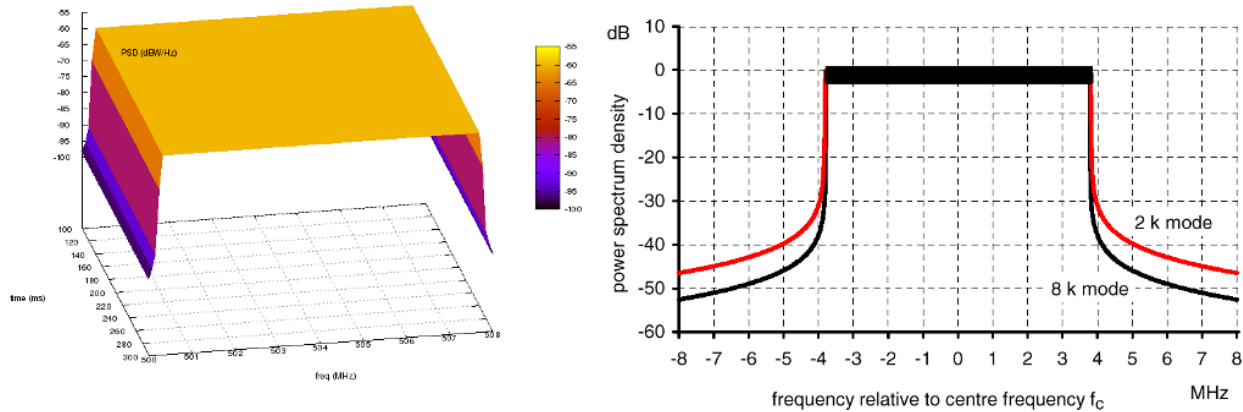

Fig. 3: 8K COFDM signal spectrum generated from `TvSpectrumTransmitter` (Left) and theoretical COFDM signal spectrum [`KoppCOFDM`] (Right)

models used in simulation are configured in the `SpectrumChannel` that the user chooses to use. Terrain and spherical Earth/horizon effects may be supported in future ns-3 propagation loss models.

After the attributes are set, along with the `SpectrumChannel`, `MobilityModel`, and node locations, the PSD of the TV transmitter signal can be created and transmitted on the channel.

### Helper Class

The helper class, `TvSpectrumTransmitterHelper`, consists of features to assist users in setting up TV transmitters for their simulations. Functionality is also provided to easily simulate real-world scenarios.

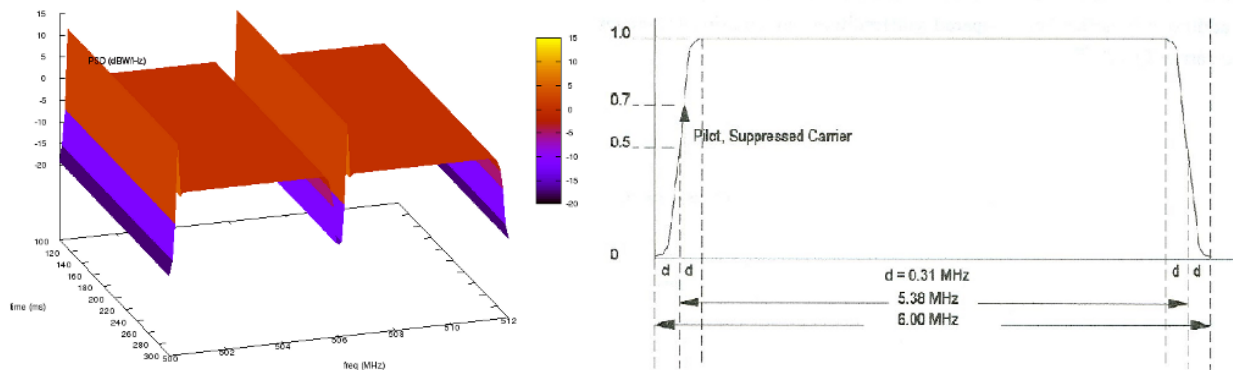

Fig. 4: North America ATSC channel 19 & 20 signals generated using `TvSpectrumTransmitterHelper` (Left) and theoretical 8-VSB signal [`Baron8VSB`] (Right). Note that the theoretical signal is not shown in dB while the ns-3 generated signals are.

Using this helper class, users can easily set up TV transmitters right after configuring attributes. Multiple transmitters can be created at a time. Also included are real characteristics of specific geographic regions that can be used to run realistic simulations. The regions currently included are North America, Europe, and Japan. The frequencies and bandwidth of each TV channel for each these regions are provided.

A method (`CreateRegionalTvTransmitters`) is provided that enables users to randomly generate multiple TV transmitters from a specified region with a given density within a chosen radius around a point on Earth's surface. The region, which determines the channel frequencies of the generated TV transmitters, can be specified to be one of the three

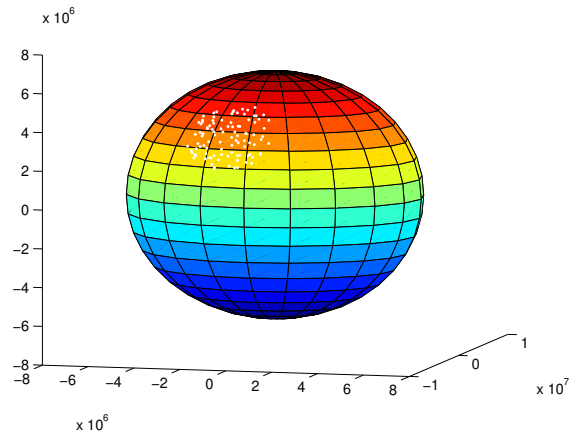

Fig. 5: Plot from MATLAB implementation of `CreateRegionalTvTransmitters` method in `TvSpectrumTransmitterHelper`. Shows 100 random points on Earth's surface (with altitude 0) corresponding to TV transmitter locations within a 2000 km radius of  $35^\circ$  latitude and  $-100^\circ$  longitude.

provided, while the density determines the amount of transmitters generated. The TV transmitters' antenna heights (altitude) above Earth's surface can also be randomly generated to be within a given maximum altitude. This method models Earth as a perfect sphere, and generated location points are referenced accordingly in Earth-Centered Earth-Fixed Cartesian coordinates. Note that bodies of water on Earth are not considered in location point generation—TV transmitters can be generated anywhere on Earth around the origin point within the chosen maximum radius.

## Examples

Two example simulations are provided that demonstrate the functionality of the TV transmitter model. `tv-trans-example` simulates two 8-VSB TV transmitters with adjacent channel frequencies. `tv-trans-regional-example` simulates randomly generated COFDM TV transmitters (modeling the DVB-T standard) located around the Paris, France area with channel frequencies and bandwidths corresponding to the European television channel allocations.

## Testing

The `tv-spectrum-transmitter` test suite verifies the accuracy of the spectrum/PSD model in `TvSpectrumTransmitter` by testing if the maximum power spectral density, start frequency, and end frequency comply with expected values for various test cases.

The `tv-helper-distribution` test suite verifies the functionality of the method in `TvSpectrumTransmitterHelper` that generates a random number of TV transmitters based on the given density (low, medium, or high) and maximum number of TV channels. It verifies that the number of TV transmitters generated does not exceed the expected bounds.

The `CreateRegionalTvTransmitters` method in `TvSpectrumTransmitterHelper` described in *Helper Class* uses two methods from the `GeographicPositions` class in the Mobility module to generate the random Cartesian points on or above earth's surface around an origin point which correspond to TV transmitter positions. The first method converts Earth geographic coordinates to Earth-Centered Earth-Fixed (ECEF) Cartesian coordinates, and is tested in the `geo-to-cartesian` test suite by comparing (with 10 meter tolerance) its output with the output of the geographic to ECEF conversion function [MatlabGeo] of the MATLAB Mapping Toolbox for numerous test cases. The other used method generates random ECEF Cartesian points around the given geographic origin point, and is tested in the `rand-cart-around-geo` test suite by verifying that the generated points do not exceed the given maximum distance radius from the origin point.

## 29.4.2 3GPP TR 38.901 fast fading model

The framework described by TR 38.901 [TR38901] is a 3D statistical Spatial Channel Model supporting different propagation environments (e.g., urban, rural, indoor), multi-antenna operations and the modeling of wireless channels between 0.5 and 100 GHz. The overall channel is represented by the matrix  $H(t, \tau)$ , in which each entry  $H_{u,s}(t, \tau)$  corresponds to the impulse response of the channel between the  $s$ -th element of the transmitting antenna and the  $u$ -th element of the receiving antenna.  $H_{u,s}(t, \tau)$  is generated by the superposition of  $N$  different multi-path components, called clusters, each of which composed of  $M$  different rays. The channel matrix generation procedure accounts for large and small scale propagation phenomena. The classes `ThreeGppSpectrumPropagationLossModel` and `ThreeGppChannelModel` included in the spectrum module takes care of the generation of the channel coefficients and the computation of the frequency-dependent propagation loss.

### Implementation

Our implementation is described in [Zugno]. It is based on the model described in [Zhang], but the code has been refactored, extended, and aligned to TR 38.901 [TR38901]. The fundamental assumption behind this model is the channel reciprocity, i.e., the impulse response of the channel between node a and node b is the same as between node b and node a. To deal with the equivalence of the channel between a and b, no matter who is the transmitter and who is the receiver, the model considers the pair of nodes to be composed by one “s” and one “u” node. The channel matrix, as well as other parameters, are saved and used under the assumption that, within a pair, the definition of the “s” and “u” node will always be the same. For more details, please have a look at the documentation of the classes `ThreeGppChannelModel` and `ThreeGppSpectrumPropagationLossModel`.

#### Note:

- Currently, no error model is provided; a link-to-system campaign may be needed to incorporate it in existing modules.
- The model does not include any spatial consistency update procedure (see [TR38901], Sec. 7.6.1). The implementation of this feature is left as future work.
- Issue regarding the blockage model: according to 3GPP TR 38.901 v15.0.0 (2018-06) section 7.6.4.1, the blocking region for self-blocking is provided in LCS.

However, here, `clusterAOA` and `clusterZOA` are in GCS and blocking check is performed for self-blocking similar to non-self blocking, that is in GCS. One would expect the angles to be transposed to LCS before checking self-blockage.

### ThreeGppSpectrumPropagationLossModel

The class `ThreeGppSpectrumPropagationLossModel` extends the `SpectrumPropagationLossModel` interface and enables the modeling of frequency dependent propagation phenomena. The main method is `DoCalcRxPowerSpectralDensity`, which takes as input the power spectral density (PSD) of the transmitted signal, the mobility models of the transmitting node and receiving node, and returns the PSD of the received signal.

Procedure used to compute the PSD of to compute the PSD of the received signal:

1. Retrieve the beamforming vectors To account for the beamforming, `ThreeGppSpectrumPropagationLossModel` has to retrieve the beamforming vectors of the transmitting and receiving antennas. The method `DoCalcRxPowerSpectralDensity` uses `m_deviceAntennaMap` to obtain the antenna objects associated to the transmitting and receiving devices, and calls the method `GetCurrentBeamformingVector` to retrieve the beamforming vectors. For each device using the channel, the `m_deviceAntennaMap` contains the associated antenna object of type `ThreeGppAntennaArrayModel`. Since the mapping is one-to-one, the model supports a single antenna object for each device. The `m_deviceAntennaMap` has to be initialized by inserting the device-antenna pairs using the method `AddDevice`.

2. Retrieve the channel matrix The `ThreeGppSpectrumPropagationLossModel` relies on the `ThreeGppChannelModel` class to obtain the channel matrix. In particular, it makes use of the method `GetChannel`, which returns a `ChannelMatrix` object containing the channel matrix and other channel parameters. The `ThreeGppChannelModel` instance is automatically created in the `ThreeGppSpectrumPropagationLossModel` constructor and it can be configured using the method `SetChannelModelAttribute ()`.

4. Compute the long term component The method `GetLongTerm` returns the long term component obtained by multiplying the channel matrix and the beamforming vectors. To reduce the computational load, the long term components associated to the different channels are stored in the `m_longTermMap` and recomputed only if the associated channel matrix is updated or if the transmitting and/or receiving beamforming vectors have changed. Given the channel reciprocity assumption, for each node pair a single long term component is saved in the map.

5. Apply the small scale fading and compute the channel gain The method `CalcBeamformingGain` computes the channel gain in each sub-band and applies it to the PSD of the transmitted signal to obtain the received PSD. To compute the sub-band gain, it accounts for the Doppler phenomenon and the time dispersion effect on each cluster. In order to reduce the computational load, the Doppler component of each cluster is computed considering only the central ray. Also, as specified [here](#), it is possible to account for the effect of environmental scattering following the model described in Sec. 6.2.3 of 3GPP TR 37.885. This is done by deviating the Doppler frequency by a random value, whose distribution depends on the parameter  $v_{scatt}$ . The value of  $v_{scatt}$  can be configured using the attribute “vScatt” (by default it is set to 0, so that the scattering effect is not considered).

### ThreeGppChannelModel

The class `ThreeGppChannelModel` implements the channel matrix generation procedure described in Sec. of [TR38901]. The main method is `GetChannel`, which takes as input the mobility models of the transmitter and receiver nodes, the associated antenna objects, and returns a `ChannelMatrix` object containing:

- the channel matrix of size  $U \times S \times N$ , where  $U$  is the number of receiving antenna elements,  $S$  is the number of transmitting antenna elements and  $N$  is the number of clusters
- the clusters delays, as an array of size  $N$
- the clusters arrival and departure angles, as a 2D array in which each row corresponds to a direction (AOA, ZOA, AOD, ZOD) and each column corresponds to a different cluster
- a time stamp indicating the time at which the channel matrix was generated
- the node IDs
- other channel parameters

The `ChannelMatrix` objects are saved in the map `m_channelMap` and updated when the coherence time expires, or in case the LOS/NLOS channel condition changes. The coherence time can be configured through the attribute “UpdatePeriod”, and should be chosen by taking into account all the factors that affects the channel variability, such as mobility, frequency, propagation scenario, etc. By default, it is set to 0, which means that the channel is recomputed only when the LOS/NLOS condition changes. It is possible to configure the propagation scenario and the operating frequency of interest through the attributes “Scenario” and “Frequency”, respectively.

**Blockage model:** 3GPP TR 38.901 also provides an optional feature that can be used to model the blockage effect due to the presence of obstacles, such as trees, cars or humans, at the level of a single cluster. This differs from a complete blockage, which would result in an LOS to NLOS transition. Therefore, when this feature is enabled, an additional attenuation is added to certain clusters, depending on their angle of arrival. There are two possible methods for the computation of the additional attenuation, i.e., stochastic (Model A) and geometric (Model B). In this work, we used the implementation provided by [Zhang], which uses the stochastic method. In particular, the model is implemented by the method `CalcAttenuationOfBlockage`, which computes the additional attenuation. The blockage feature can be disabled through the attribute “Blockage”. Also, the attributes “NumNonselBlockage”, “PortraitMode” and “BlockerSpeed” can be used to configure the model.

## Testing

The test suite `ThreeGppChannelTestSuite` includes three test cases:

- `ThreeGppChannelMatrixComputationTest` checks if the channel matrix has the correct dimensions and if it is correctly normalized
- `ThreeGppChannelMatrixUpdateTest`, which checks if the channel matrix is correctly updated when the coherence time exceeds
- `ThreeGppSpectrumPropagationLossModelTest`, which tests the functionalities of the class `ThreeGppSpectrumPropagationLossModel`. It builds a simple network composed of two nodes, computes the power spectral density received by the receiving node, and
  1. Checks if the long term components for the direct and the reverse link are the same,
  2. Checks if the long term component is updated when changing the beamforming vectors,
  3. Checks if the long term is updated when changing the channel matrix

**Note:** TR 38.901 includes a calibration procedure that can be used to validate the model, but it requires some additional features which are not currently implemented, thus is left as future work.

## References



## 6LOWPAN: TRANSMISSION OF IPV6 PACKETS OVER IEEE 802.15.4 NETWORKS

This chapter describes the implementation of *ns-3* model for the compression of IPv6 packets over IEEE 802.15.4-Based Networks as specified by [RFC 4944](#) (“Transmission of IPv6 Packets over IEEE 802.15.4 Networks”) and [RFC 6282](#) (“Compression Format for IPv6 Datagrams over IEEE 802.15.4-Based Networks”).

### 30.1 Model Description

The source code for the `sixlowpan` module lives in the directory `src/sixlowpan`.

#### 30.1.1 Design

The model design does not follow strictly the standard from an architectural standpoint, as it does extend it beyond the original scope by supporting also other kinds of networks.

Other than that, the module strictly follows [RFC 4944](#) and [RFC 6282](#), with the following exceptions:

- HC2 encoding is not supported
- IPHC’s SAC and DAC are not supported

The HC2 encoding is not supported, as it has been superseded by IPHC and NHC compression type ([RFC 6282](#)).

IPHC SAC and DAC are not yet supported, as they do require [RFC 6775](#) (“Neighbor Discovery Optimization for IPv6 over Low-Power Wireless Personal Area Networks (6LoWPANs)”) for full compliance. It is planned to support them in the future.

#### NetDevice

The whole module is developed as a transparent `NetDevice`, which can act as a proxy between IPv6 and any `NetDevice` (the module has been successfully tested with `PointToPointNedevic`, `CsmaNetDevice` and `LrWpanNetDevice`).

For this reason, the module implements a virtual `NetDevice`, and all the calls are passed without modifications to the underlying `NetDevice`. The only important difference is in `GetMtu` behaviour. It will always return *at least* 1280 bytes, as is the minimum IPv6 MTU.

The module does provide some attributes and some tracesources. The attributes are:

- `Rfc6282` (boolean, default true), used to activate HC1 ([RFC 4944](#)) or IPHC ([RFC 6282](#)) compression.
- `OmitUdpChecksum` (boolean, default true), used to activate UDP checksum compression in IPHC.

- `FragmentReassemblyListSize` (integer, default 0), indicating the number of packets that can be reassembled at the same time. If the limit is reached, the oldest packet is discarded. Zero means infinite.
- `FragmentExpirationTimeout` (Time, default 60 seconds), being the timeout to wait for further fragments before discarding a partial packet.
- `CompressionThreshold` (unsigned 32 bits integer, default 0), minimum compressed payload size.
- `ForceEtherType` (boolean, default false).
- `EtherType` (unsigned 16 bits integer, default 0xFFFF), to force a particular L2 EtherType.
- `UseMeshUnder` (boolean, default false), it enables mesh-under flood routing.
- `MeshUnderRadius` (unsigned 8 bits integer, default 10), the maximum number of hops that a packet will be forwarded.
- `MeshCacheLength` (unsigned 16 bits integer, default 10), the length of the cache for each source.
- `MeshUnderJitter` (`ns3::UniformRandomVariable[Min=0.0|Max=10.0]`), the jitter in ms a node uses to forward mesh-under packets - used to prevent collisions.

The `CompressionThreshold` attribute is similar to Contiki's `SICSLOWPAN_CONF_MIN_MAC_PAYLOAD` option. If a compressed packet size is less than the threshold, the uncompressed version is used (plus one byte for the correct dispatch header). This option is useful when a MAC requires a minimum frame size (e.g., ContikiMAC) and the compression would violate the requirement.

The last two attributes are needed to use the module with a `NetDevice` other than 802.15.4, as neither IANA or IEEE did reserve an EtherType for 6LoWPAN. As a consequence there might be a conflict with the L2 multiplexer/demultiplexer which is based on EtherType. The default value is 0xFFFF, which is reserved by IEEE (see [\[IANA802\]](#) and [\[EtherType\]](#)). The default module behaviour is to not change the EtherType, however this would not work with any `NetDevice` actually understanding and using the EtherType.

Note that the `ForceEtherType` parameter have also a direct effect on the MAC address kind the module is expecting to handle: \* `ForceEtherType true`: `Mac48Address` (Ethernet, WiFi, etc.). \* `ForceEtherType false`: `Mac16Address` or `Mac64Address` (IEEE 802.15.4).

Note that using 6LoWPAN over any `NetDevice` other than 802.15.4 will produce valid .pcap files, but they will not be correctly dissected by Wireshark. The reason lies on the fact that 6LoWPAN was really meant to be used only over 802.15.4, so Wireshark dissectors will not even try to decode 6LoWPAN headers on top of protocols other than 802.15.4.

The Trace sources are:

- Tx - exposing packet (including 6LoWPAN header), `SixLoWPanNetDevice Ptr`, interface index.
- Rx - exposing packet (including 6LoWPAN header), `SixLoWPanNetDevice Ptr`, interface index.
- Drop - exposing `DropReason`, packet (including 6LoWPAN header), `SixLoWPanNetDevice Ptr`, interface index.

The Tx and Rx traces are called as soon as a packet is received or sent. The Drop trace is invoked when a packet (or a fragment) is discarded.

## Mesh-Under routing

The module provides a very simple mesh-under routing [\[Shelby\]](#), implemented as a flooding (a mesh-under routing protocol is a routing system implemented below IP).

This functionality can be activated through the `UseMeshUnder` attribute and fine-tuned using the `MeshUnderRadius` and `MeshUnderJitter` attributes.

Note that flooding in a PAN generates a lot of overhead, which is often not wanted. Moreover, when using the mesh-under facility, ALL the packets are sent without acknowledgment because, at lower level, they are sent to a broadcast address.

At node level, each packet is re-broadcasted if its BC0 Sequence Number is not in the cache of the recently seen packets. The cache length (by default 10) can be changed through the MeshCacheLength attribute.

### 30.1.2 Scope and Limitations

#### Context-based compression

The present implementation does not support context-based (stateful) compression. This limitation will be removed in the future.

#### 6LoWPAN-ND

Future versions of this module will support [RFC 6775](#), however no timeframe is guaranteed.

#### Mesh-under routing

It would be a good idea to improve the mesh-under flooding by providing the following:

- Adaptive hop-limit calculation,
- Adaptive forwarding jitter,
- Use of direct (non mesh) transmission for packets directed to 1-hop neighbors.

#### Mixing compression types in a PAN

The IPv6/MAC addressing scheme defined in [RFC 6282](#) and [RFC 4944](#) is different. One adds the PanId in the pseudo-MAC address (4944) and the other doesn't (6282).

The expected use cases (confirmed by the RFC editor) is to *never* have a mixed environment where part of the nodes are using HC1 and part IPHC because this would lead to confusion on what the IPv6 address of a node is.

Due to this, the nodes configured to use IPHC will drop the packets compressed with HC1 and viceversa. The drop is logged in the drop trace as `DROP_DISALLOWED_COMPRESSION`.

#### Using 6LoWPAN with IPv4 (or other L3 protocols)

As the name implies, 6LoWPAN can handle only IPv6 packets. Any other protocol will be discarded. Moreover, 6LoWPAN assumes that the network is uniform, as is all the devices connected by the same same channel are using 6LoWPAN. Mixed environments are not supported by the standard. The reason is simple: 802.15.4 frame doesn't have a "protocol" field. As a consequence, there is no demultiplexing at MAC layer and the protocol carried by L2 frames must be known in advance.

In the *ns-3* implementation it is possible, but not advisable, to violate this requirement if the underlying NetDevice is capable of discriminating different protocols. As an example, CsmNetDevice can carry IPv4 and 6LoWPAN at the same time. However, this configuration has not been tested.

### 30.1.3 References

## 30.2 Usage

### 30.2.1 Enabling sixlowpan

Add `sixlowpan` to the list of modules built with `ns-3`.

### 30.2.2 Helper

The helper is patterned after other device helpers.

### 30.2.3 Examples

The following example can be found in `src/sixlowpan/examples/`:

- `example-sixlowpan.cc`: A simple example showing end-to-end data transfer.

In particular, the example enables a very simplified end-to-end data transfer scenario, with a CSMA network forced to carry 6LoWPAN compressed packets.

### 30.2.4 Tests

The test provided checks the connection between two UDP clients and the correctness of the received packets.

## 30.3 Validation

The model has been validated against WireShark, checking whatever the packets are correctly interpreted and validated.

## TOPOLOGY INPUT READERS

The topology modules aim at reading a topology file generated by an automatic topology generator.

The process is divided in two steps:

- running a topology generator to build a topology file
- reading the topology file and build a ns-3 simulation

Hence, model is focused on being able to read correctly the various topology formats.

Currently there are three models:

- `ns3::OrbisTopologyReader` for [Orbis 0.7](#) traces
- `ns3::InetTopologyReader` for [Inet 3.0](#) traces
- `ns3::RocketfuelTopologyReader` for [Rocketfuel](#) traces

An helper `ns3::TopologyReaderHelper` is provided to assist on trivial tasks.

A good source for topology data is also [Archipelago](#).

The current Archipelago [Measurements](#), monthly updated, are stored in the CAIDA website using a complete notation and triple data source, one for each working group.

A different and more compact notation reporting only the AS-relationships (a sort of more Orbis-like format) is here: [as-relationships](#).

The compact notation can be easily stripped down to a pure Orbis format, just removing the double relationships (the compact format use one-way links, while Orbis use two-way links) and pruning the 3rd parameter. Note that with the compact data Orbis can then be used create a rescaled version of the topology, thus being the most effective way (to my best knowledge) to make an internet-like topology.

Examples can be found in the directory `src/topology-read/examples/`



## TRAFFIC CONTROL LAYER

### 32.1 Traffic Control Layer

The Traffic Control layer aims at introducing an equivalent of the Linux Traffic Control infrastructure into ns-3. The Traffic Control layer sits in between the NetDevices (L2) and any network protocol (e.g. IP). It is in charge of processing packets and performing actions on them: scheduling, dropping, marking, policing, etc.

#### 32.1.1 Introducing the Traffic Control Layer

The Traffic Control layer intercepts both outgoing packets flowing downwards from the network layer to the network device and incoming packets flowing in the opposite direction. Currently, only outgoing packets are processed by the Traffic Control layer. In particular, outgoing packets are enqueued in a queuing discipline, which can perform multiple actions on them.

In the following, more details are given about how the Traffic Control layer intercepts outgoing and incoming packets and, more in general, about how the packets traverse the network stack.

##### Transmitting packets

The IPv{4,6} interfaces uses the aggregated object TrafficControlLayer to send down packets, instead of calling NetDevice::Send() directly. After the analysis and the process of the packet, when the backpressure mechanism allows it, TrafficControlLayer will call the Send() method on the right NetDevice.

##### Receiving packets

The callback chain that (in the past) involved IPv{4,6}L3Protocol and NetDevices, through ReceiveCallback, is extended to involve TrafficControlLayer. When an IPv{4,6}Interface is added in the IPv{4,6}L3Protocol, the callback chain is configured to have the following packet exchange:

NetDevice → Node → TrafficControlLayer → IPv{4,6}L3Protocol

#### 32.1.2 Brief description of old node/device/protocol interactions

The main question that we would like to answer in the following paragraphs is: how a ns-3 node can send/receive packets?

If we analyze any example out there, the ability of the node to receive/transmit packets derives from the interaction of two helper:

- L2 Helper (something derived from NetDevice)

- L3 Helper (usually from Internet module)

### L2 Helper main operations

Any good L2 Helper will do the following operations:

- Create  $n$  netdevices ( $n > 1$ )
- Attach a channel between these devices
- Call `Node::AddDevice ()`

Obviously the last point is the most important.

`Node::AddDevice (network/model/node.cc:128)` assigns an interface index to the device, calls `NetDevice::SetNode`, sets the receive callback of the device to `Node::NonPromiscReceiveFromDevice`. Then, it schedules `NetDevice::Initialize()` method at `Seconds(0.0)`, then notify the registered `DeviceAdditionListener` handlers (not used BY ANYONE).

`Node::NonPromiscReceiveFromDevice` calls `Node::ReceiveFromDevice`.

`Node::ReceiveFromDevice` iterates through `ProtocolHandlers`, which are callbacks which accept as signature:

`ProtocolHandler (Ptr<NetDevice>, Ptr<const Packet>, protocol, from_addr, to_addr, packetType)`.

If device, protocol number and promiscuous flag corresponds, the handler is invoked.

Who is responsible to set `ProtocolHandler` ? We will analyze that in the next section.

### L3 Helper

We have only internet which provides network protocol (IP). That module splits the operations between two helpers: `InternetStackHelper` and `Ipv4AddressHelper`.

`InternetStackHelper::Install (internet/helper/internet-stack-helper.cc:423)` creates and aggregates protocols `{ArpL3, Ipv4L3, Icmpv4}` `Protocol`. It creates the routing protocol, and if `Ipv6` is enabled it adds `{Ipv6L3, Icmpv6L4}` `Protocol`. In any case, it instantiates and aggregates an `UdpL4Protocol` object, along with a `PacketSocketFactory`. Ultimately, it creates the required objects and aggregates them to the node.

Let's assume an `Ipv4` environment (things are the same for `Ipv6`).

`Ipv4AddressHelper::Assign (src/internet/helper/ipv4-address-helper.cc:131)` registers the handlers. The process is a bit long. The method is called with a list of `NetDevice`. For each of them, the node and `Ipv4L3Protocol` pointers are retrieved; if an `Ipv4Interface` is already registered for the device, on that the address is set. Otherwise, the method `Ipv4L3Protocol::AddInterface` is called, before adding the address.

### IP interfaces

In `Ipv4L3Protocol::AddInterface (src/internet/model/ipv4-l3-protocol.cc:300)` two protocol handlers are installed: one that react to `ipv4` protocol number, and one that react to `arp` protocol number (`Ipv4L3Protocol::Receive` and `ArpL3Protocol::Receive`, respectively). The interface is then created, initialized, and returned.

`Ipv4L3Protocol::Receive (src/internet/model/ipv4-l3-protocol.cc:472)` iterates through the interface. Once it finds the `Ipv4Interface` which has the same device as the one passed as argument, invokes the `rxTrace` callback. If the interface is down, the packet is dropped. Then, it removes the header and trim any residual frame padding. If checksum is not OK, it drops the packet. Otherwise, forward the packet to the raw sockets (not used). Then, it ask the routing protocol what is the destiny of that packet. The choices are: `Ipv4L3Protocol::{IpForward, IpMulticastForward, LocalDeliver, RouteInputError}`.



## 32.2 Queue disciplines

### 32.2.1 Model Description

Packets received by the Traffic Control layer for transmission to a netdevice can be passed to a queueing discipline (queue disc) to perform scheduling and policing. The *ns-3* term “queue disc” corresponds to what Linux calls a “qdisc”. A netdevice can have a single (root) queue disc installed on it. Installing a queue disc on a netdevice is not mandatory. If a netdevice does not have a queue disc installed on it, the traffic control layer sends the packets directly to the netdevice. This is the case, for instance, of the loopback netdevice.

As in Linux, queue discs may be simple queues or may be complicated hierarchical structures. A queue disc may contain distinct elements:

- queues, which actually store the packets waiting for transmission
- classes, which permit the definition of different treatments for different subdivisions of traffic
- filters, which determine the queue or class which a packet is destined to

Linux uses the terminology “classful qdiscs” or “classless qdiscs” to describe how packets are handled. This use of the term “class” should be distinguished from the C++ language “class”. In general, the below discussion uses “class” in the Linux, not C++, sense, but there are some uses of the C++ term, so please keep in mind the dual use of this term in the below text.

Notice that a child queue disc must be attached to every class and a packet filter is only able to classify packets of a single protocol. Also, while in Linux some queue discs (e.g., fq-codel) use an internal classifier and do not make use of packet filters, in *ns-3* every queue disc including multiple queues or multiple classes needs an external filter to classify packets (this is to avoid having the traffic-control module depend on other modules such as internet).

Queue disc configuration vary from queue disc to queue disc. A typical taxonomy divides queue discs in classful (i.e., support classes) and classless (i.e., do not support classes). More recently, after the appearance of multi-queue devices (such as Wi-Fi), some multi-queue aware queue discs have been introduced. Multi-queue aware queue discs handle as many queues (or queue discs – without using classes) as the number of transmission queues used by the device on which the queue disc is installed. An attempt is made, also, to classify each packet similarly in the queue disc and within the device (i.e., to keep the packet classification consistent across layers).

The traffic control layer interacts with a queue disc in a simple manner: after requesting to enqueue a packet, the traffic control layer requests the qdisc to “run”, i.e., to dequeue a set of packets, until a predefined number (“quota”) of packets is dequeued or the netdevice stops the queue disc. A netdevice shall stop the queue disc when its transmission queue does not have room for another packet. Also, a netdevice shall wake the queue disc when it detects that there is room for another packet in its transmission queue, but the transmission queue is stopped. Waking a queue disc is equivalent to make it run.

Every queue disc collects statistics about the total number of packets/bytes received from the upper layers (in case of root queue disc) or from the parent queue disc (in case of child queue disc), enqueued, dequeued, requeued, dropped, dropped before enqueue, dropped after dequeue, marked, and stored in the queue disc and sent to the netdevice or to the parent queue disc. Note that packets that are dequeued may be requeued, i.e., retained by the traffic control infrastructure, if the netdevice is not ready to receive them. Requeued packets are not part of the queue disc. The following identities hold:

- dropped = dropped before enqueue + dropped after dequeue
- received = dropped before enqueue + enqueued
- queued = enqueued - dequeued
- sent = dequeued - dropped after dequeue (- 1 if there is a requeued packet)

Separate counters are also kept for each possible reason to drop a packet. When a packet is dropped by an internal queue, e.g., because the queue is full, the reason is “Dropped by internal queue”. When a packet is dropped by a child

queue disc, the reason is “(Dropped by child queue disc)” followed by the reason why the child queue disc dropped the packet.

The QueueDisc base class provides the SojournTime trace source, which provides the sojourn time of every packet dequeued from a queue disc, including packets that are dropped or requeued after being dequeued. The sojourn time is taken when the packet is dequeued from the queue disc, hence it does not account for the additional time the packet is retained within the queue disc in case it is requeued.

## Design

A C++ abstract base class, class QueueDisc, is subclassed to implement a specific queue disc. A subclass is required to implement the following methods:

- `bool DoEnqueue (Ptr<QueueDiscItem> item):` Enqueue a packet
- `Ptr<QueueDiscItem> DoDequeue (void):` Dequeue a packet
- `bool CheckConfig (void) const:` Check if the configuration is correct
- `void InitializeParams (void):` Initialize queue disc parameters

and may optionally override the default implementation of the following method:

- `Ptr<const QueueDiscItem> DoPeek (void) const:` Peek the next packet to extract

The default implementation of the `DoPeek` method is based on the `qdisc_peek_dequeued` function of the Linux kernel, which dequeues a packet and retains it in the queue disc as a requeued packet. This approach is recommended especially for queue discs for which it is not obvious what is the next packet that will be dequeued (e.g., queue discs having multiple internal queues or child queue discs or queue discs that drop packets after dequeue). Therefore, unless the subclass redefines the `DoPeek` method, calling `Peek` causes the next packet to be dequeued from the queue disc, though the packet is still considered to be part of the queue disc and the dequeue trace is fired when `Dequeue` is called and the packet is actually extracted from the queue disc.

The C++ base class QueueDisc implements:

- methods to add/get a single queue, class or filter and methods to get the number of installed queues, classes or filters
- a `Classify` method which classifies a packet by processing the list of filters until a filter able to classify the packet is found
- methods to extract multiple packets from the queue disc, while handling transmission (to the device) failures by requeuing packets

The base class QueueDisc provides many trace sources:

- `Enqueue`
- `Dequeue`
- `Requeue`
- `Drop`
- `Mark`
- `PacketsInQueue`
- `BytesInQueue`

The C++ base class QueueDisc holds the list of attached queues, classes and filter by means of three vectors accessible through attributes (`InternalQueueList`, `QueueDiscClassList` and `PacketFilterList`).

Internal queues are implemented as (subclasses of) Queue objects. A Queue stores QueueItem objects, which consist of just a Ptr<Packet>. Since a queue disc has to store at least the destination address and the protocol number for each enqueued packet, a new C++ class, QueueDiscItem, is derived from QueueItem to store such additional information for each packet. Thus, internal queues are implemented as Queue objects storing QueueDiscItem objects. Also, there could be the need to store further information depending on the network layer protocol of the packet. For instance, for IPv4 and IPv6 packets it is needed to separately store the header and the payload, so that header fields can be manipulated, e.g., to support Explicit Congestion Notification as defined in RFC 3168. To this end, subclasses Ipv4QueueDiscItem and Ipv6QueueDiscItem are derived from QueueDiscItem to additionally store the IP header and provide protocol specific operations such as ECN marking.

Classes (in the Linux sense of the term) are implemented via the QueueDiscClass class, which consists of a pointer to the attached queue disc. Such a pointer is accessible through the QueueDisc attribute. Classful queue discs needing to set parameters for their classes can subclass QueueDiscClass and add the required parameters as attributes.

An abstract base class, PacketFilter, is subclassed to implement specific filters. Subclasses are required to implement two virtual private pure methods:

- `bool CheckProtocol (Ptr<QueueDiscItem> item) const`: check whether the filter is able to classify packets of the same protocol as the given packet
- `int32_t DoClassify (Ptr<QueueDiscItem> item) const`: actually classify the packet

PacketFilter provides a public method, `Classify`, which first calls `CheckProtocol` to check that the protocol of the packet matches the protocol of the filter and then calls `DoClassify`. Specific filters subclassed from PacketFilter should not be placed in the traffic-control module but in the module corresponding to the protocol of the classified packets.

## 32.2.2 Usage

The traffic control layer is automatically created and inserted on an `ns3::Node` object when typical device and internet module helpers are used. By default, the `InternetStackHelper::Install()` method aggregates a `TrafficControlLayer` object to every node. When invoked to assign an IPv{4,6} address to a device, the `Ipv{4,6}AddressHelper`, besides creating an `Ipv{4,6}Interface`, also installs the default qdisc on the device, unless a queue disc has been already installed. For single-queue `NetDevices` (such as `PointToPoint`, `Csma` and `Simple`), the default root qdisc is `FqCoDel`. For multi-queue `NetDevices` (such as `Wifi`), the default root qdisc is `Mq` with as many `FqCoDel` child qdiscs as the number of device queues.

To install a queue disc other than the default one, it is necessary to install such queue disc before an IP address is assigned to the device. Alternatively, the default queue disc can be removed from the device after assigning an IP address, by using the `Uninstall` method of the `TrafficControlHelper` C++ class, and then installing a different queue disc on the device. By uninstalling without adding a new queue disc, it is also possible to have no queue disc installed on a device.

## Helpers

A typical usage pattern is to create a traffic control helper and to configure type and attributes of queue discs, queues, classes and filters from the helper. For example, the `pfifo_fast` can be configured as follows:

```
TrafficControlHelper tch;
uint16_t handle = tch.SetRootQueueDisc ("ns3::PfifoFastQueueDisc");
tch.AddInternalQueues (handle, 3, "ns3::DropTailQueue", "MaxSize", StringValue ("1000p
↪"));
QueueDiscContainer qdiscs = tch.Install (devices);
```

The above code adds three internal queues to the root queue disc of type PfifoFast. With the above configuration, the config path of the root queue disc installed on the *j*-th device of the *i*-th node (the index of a device is the same as in DeviceList) is:

```
/NodeList/[i]/$ns3::TrafficControlLayer/RootQueueDiscList/[j]
```

and the config path of the second internal queue is:

```
/NodeList/[i]/$ns3::TrafficControlLayer/RootQueueDiscList/[j]/InternalQueueList/1
```

For this helper's configuration to take effect, it should be added to the ns-3 program after `InternetStackHelper::Install()` is called, but before IP addresses are configured using `Ipv4, 6}AddressHelper`.

### 32.2.3 Implementation details

In Linux, the struct `netdev_queue` is used to store information about a single transmission queue of a device: status (i.e., whether it has been stopped or not), data used by techniques such as Byte Queue Limits and a qdisc pointer field that is mainly used to solve the following problems:

- if a device transmission queue is (almost) empty, identify the queue disc to wake
- if a packet will be enqueued in a given device transmission queue, identify the queue disc which the packet must be enqueued into

The latter problem arises because Linux attempts to determine the device transmission queue which a packet will be enqueued into before passing the packet to a queue disc. This is done by calling a specific function of the device driver, if implemented, or by employing fallback mechanisms (such as hashing of the addresses) otherwise. The identifier of the selected device transmission queue is stored in the `queue_mapping` field of the struct `sk_buff`, so that both the queue disc and the device driver can get the same information. In ns-3, such identifier is stored in a member of the `QueueDiscItem` class.

The `NetDeviceQueue` class in ns-3 is the equivalent of the Linux struct `netdev_queue`. The `qdisc` field of the Linux struct `netdev_queue`, however, cannot be similarly stored in a `NetDeviceQueue` object, because it would make the network module depend on the traffic-control module. Instead, this information is stored in the `TrafficControlLayer` object aggregated to each node. In particular, a `TrafficControlLayer` object holds a struct `NetDeviceInfo` which stores, for each `NetDevice`, a pointer to the root queue disc installed on the device, a pointer to the `netdevice` queue interface (see below) aggregated to the device, and a vector of pointers (one for each device transmission queue) to the queue discs to activate when the above problems occur. The traffic control layer takes care of configuring such a vector at initialization time, based on the “wake mode” of the root queue disc. If the wake mode of the root queue disc is `WAKE_ROOT`, then all the elements of the vector are pointers to the root queue disc. If the wake mode of the root queue disc is `WAKE_CHILD`, then each element of the vector is a pointer to a distinct child queue disc. This requires that the number of child queue discs matches the number of `netdevice` queues. It follows that the wake mode of a classless queue disc must necessarily be `WAKE_ROOT`. These two configurations are illustrated by the figures below.

*Setup of a queue disc (wake mode: WAKE\_ROOT)* below shows how the `TrafficControlLayer` map looks like in case of a classful root queue disc whose wake mode is `WAKE_ROOT`.

*Setup of a multi-queue aware queue disc* below shows instead how the `TrafficControlLayer` map looks like in case of a classful root queue disc whose wake mode is `WAKE_CHILD`.

A `NetDeviceQueueInterface` object is used by the traffic control layer to access the information stored in the `NetDeviceQueue` objects, retrieve the number of transmission queues of the device and get the transmission queue selected for the transmission of a given packet. A `NetDeviceQueueInterface` object must be therefore aggregated to all the devices having an interface supporting the traffic control layer (i.e., an IPv4 or IPv6 interface). In particular:

- a `NetDeviceQueueInterface` object is aggregated to all the devices by the `NetDevice` helper classes, at `Install` time. See, for example, the implementation in the method `CsmaHelper::InstallPriv()`.

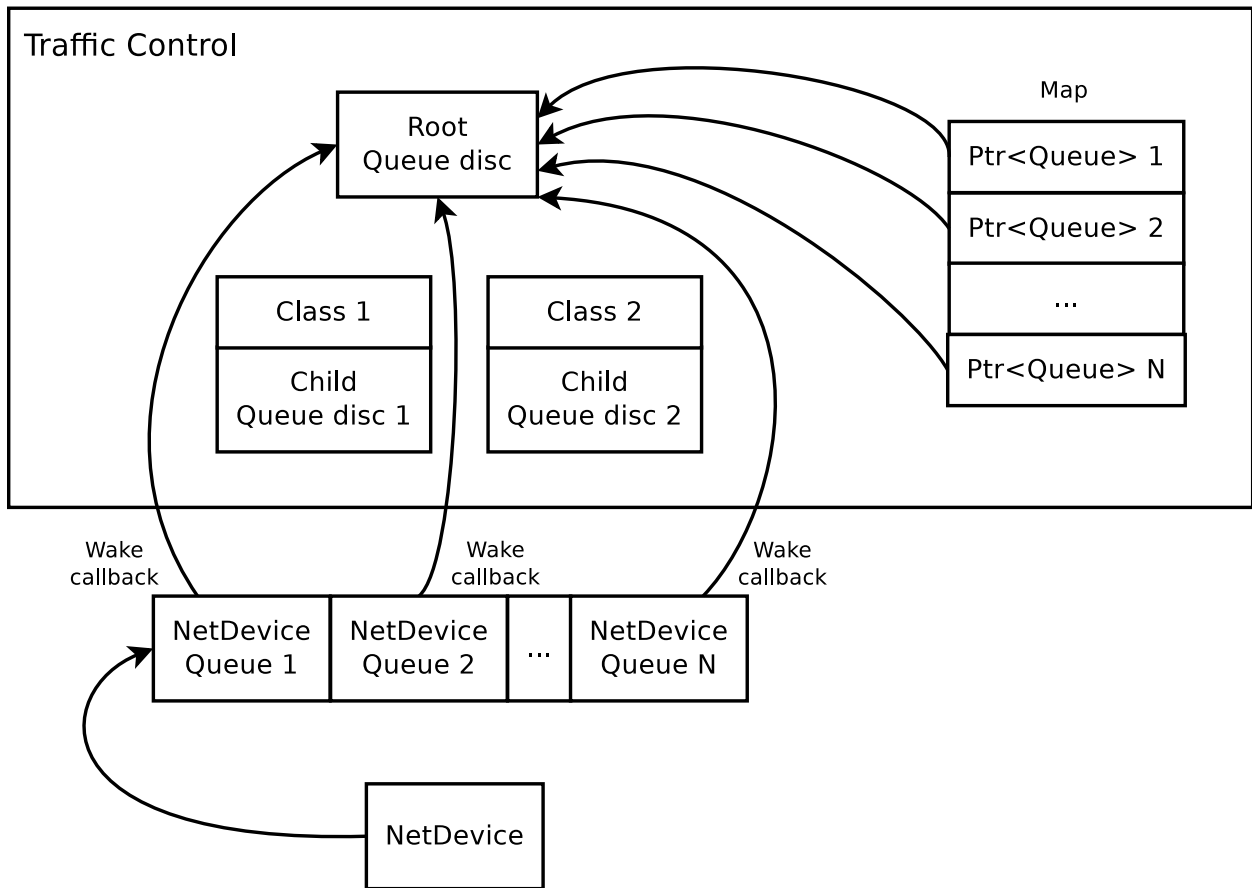

Fig. 1: Setup of a queue disc (wake mode: WAKE\_ROOT)

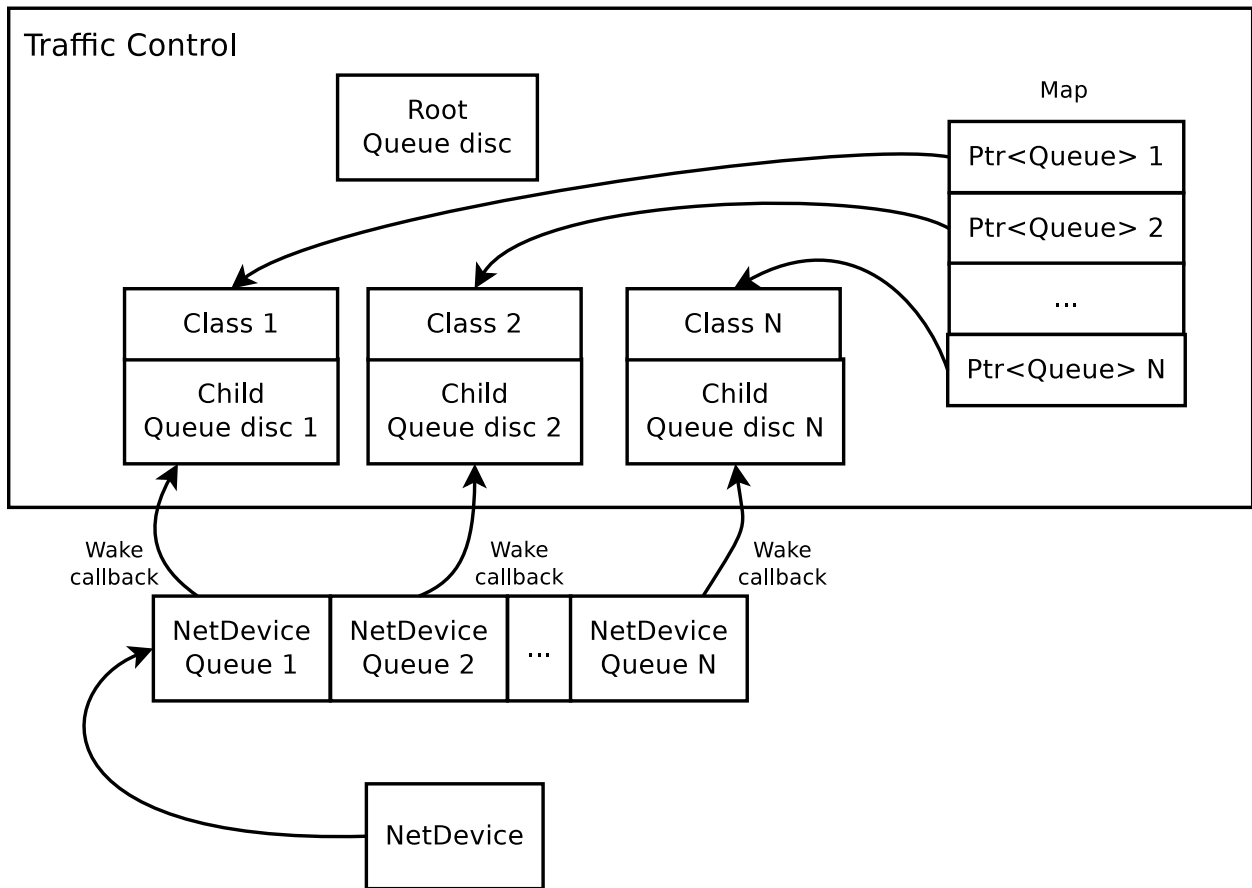

Fig. 2: Setup of a multi-queue aware queue disc

- when notified that a netdevice queue interface has been aggregated, traffic control aware devices can cache the pointer to the netdevice queue interface created by the traffic control layer into a member variable. Also, multi-queue devices can set the number of device transmission queues and set the select queue callback through the netdevice queue interface
- at initialization time, the traffic control (after calling `device->Initialize ()` to ensure that the netdevice has set the number of device transmission queues, if it has to do so) completes the installation of the queue discs by setting the wake callbacks on the device transmission queues (through the netdevice queue interface). Also, the traffic control calls the `Initialize` method of the root queue discs. This initialization of queue discs triggers calls to the `CheckConfig` and `InitializeParams` methods of the queue disc.

## Requeue

In Linux, a packet dequeued from a queue disc can be requeued (i.e., stored somewhere and sent to the device at a later time) in some circumstances. Firstly, the function used to dequeue a packet (`dequeue_skb`) actually dequeues a packet only if the device is multi-queue or the (unique) device queue is not stopped. If a packet has been dequeued from the queue disc, it is passed to the `sch_direct_xmit` function for transmission to the device. This function checks whether the device queue the packet is destined to is stopped, in which case the packet is requeued. Otherwise, the packet is sent to the device. If the device returns `NETDEV_TX_BUSY`, the packet is requeued. However, it is advised that the function called to send a packet to the device (`ndo_start_xmit`) should always return `NETDEV_TX_OK`, which means that the packet is consumed by the device driver and thus needs not to be requeued. However, the `ndo_start_xmit` function of the device driver is allowed to return `NETDEV_TX_BUSY` (and hence the packet is requeued) when there is no room for the received packet in the device queue, despite the queue is not stopped. This case is considered as a corner case or an hard error, and should be avoided.

ns-3 implements the requeue mechanism in a similar manner, the only difference being that packets are not requeued when such corner cases occur. Basically, the method used to dequeue a packet (`QueueDisc::DequeuePacket`) actually dequeues a packet only if the device is multi-queue or the (unique) device queue is not stopped. If a packet has been dequeued from the queue disc, it is passed to the `QueueDisc::Transmit` method for transmission to the device. This method checks whether the device queue the packet is destined to is stopped, in which case the packet is requeued. Otherwise, the packet is sent to the device. We request netdevices to stop a device queue when it is not able to store another packet, so as to avoid the situation in which a packet is received that cannot be enqueued while the device queue is not stopped. Should such a corner case occur, the netdevice drops the packet but, unlike Linux, the value returned by `NetDevice::Send` is ignored and the packet is not requeued.

The way the requeue mechanism is implemented in ns-3 has the following implications:

- if the underlying device has a single queue, no packet will ever be requeued. Indeed, if the device queue is not stopped when `QueueDisc::DequeuePacket` is called, it will not be stopped also when `QueueDisc::Transmit` is called, hence the packet is not requeued (recall that a packet is not requeued after being sent to the device, as the value returned by `NetDevice::Send` is ignored).
- if the underlying device does not implement flow control, i.e., it does not stop its queue(s), no packet will ever be requeued (recall that a packet is only requeued by `QueueDisc::Transmit` when the device queue the packet is destined to is stopped)

It turns out that packets may only be requeued when the underlying device is multi-queue and supports flow control.

## 32.3 Fifo queue disc

### 32.3.1 Model Description

`FifoQueueDisc` implements the FIFO (First-In First-Out) policy. Packets are enqueued in the unique internal queue, which is implemented as a `DropTail` queue. The queue disc capacity can be specified in terms of either packets or

bytes, depending on the value of the Mode attribute.

User is allowed to provide an internal queue before the queue disc is initialized. If no internal queue is provided, one DropTail queue having the same capacity of the queue disc is created by default. No packet filter can be added to a FifoQueueDisc.

## Attributes

The FifoQueueDisc class holds the following attribute:

- `MaxSize`: The maximum number of packets/bytes the queue disc can hold. The default value is 1000 packets.

### 32.3.2 Validation

The fifo model is tested using `FifoQueueDiscTestSuite` class defined in `src/traffic-control/test/fifo-queue-disc-test-suite.cc`. The test aims to check that the capacity of the queue disc is not exceeded and packets are dequeued in the correct order.

## 32.4 pfifo\_fast queue disc

### 32.4.1 Model Description

PfifoFastQueueDisc behaves like `pfifo_fast`, which is the default queue disc enabled on Linux systems (init systems such as `systemd` may override such default setting). Packets are enqueued in three priority bands (implemented as FIFO droptail queues) based on their priority (users can read *Use of `Send()` vs. `SendTo()`* for details on how to set packet priority). The four least significant bits of the priority are used to determine the selected band according to the following table:

Priority & 0xf	Band
0	1
1	2
2	2
3	2
4	1
5	2
6	0
7	0
8	1
9	1
10	1
11	1
12	1
13	1
14	1
15	1

The system behaves similar to three `ns3::DropTail` queues operating together, in which packets from higher priority bands are always dequeued before a packet from a lower priority band is dequeued.

The queue disc capacity, i.e., the maximum number of packets that can be enqueued in the queue disc, is set through the `MaxSize` attribute, which plays the same role as `txqueuelen` in Linux. If no internal queue is provided, three



DropTail queues having each a capacity equal to `MaxSize` are created by default. User is allowed to provide queues, but they must be three, operate in packet mode and each have a capacity not less than `MaxSize`. No packet filter can be added to a `PfifoFastQueueDisc`.

## Attributes

The `PfifoFastQueueDisc` class holds a single attribute:

- `MaxSize`: The maximum number of packets accepted by the queue disc. The default value is 1000.

## Examples

Various examples located in `src/traffic-control/examples` (e.g., `codel-vs-pfifo-asymmetric.cc`) shows how to configure and install a `PfifoFastQueueDisc` on internet nodes.

### 32.4.2 Validation

The `pfifo_fast` model is tested using `PfifoFastQueueDiscTestSuite` class defined in `src/test/ns3tc/pfifo-fast-queue-disc-test-suite.cc`. The suite includes 4 test cases:

- Test 1: The first test checks whether IPv4 packets are enqueued in the correct band based on the TOS byte
- Test 2: The second test checks whether IPv4 packets are enqueued in the correct band based on the TOS byte
- Test 3: The third test checks that the queue disc cannot enqueue more packets than its limit
- Test 4: The fourth test checks that packets that the filters have not been able to classify are enqueued into the default band of 1

## 32.5 Prio queue disc

### 32.5.1 Model Description

`PrioQueueDisc` implements a strict priority policy, where packets are dequeued from a band only if higher priority bands are all empty. `PrioQueueDisc` is a classful queue disc and can have an arbitrary number of bands, each of which is handled by a queue disc of any kind. The capacity of `PrioQueueDisc` is not limited; packets can only be dropped by child queue discs (which may have a limited capacity). If no packet filter is installed or able to classify a packet, then the packet is enqueued into a priority band based on its priority (modulo 16), which is used as an index into an array called `priomap`. Users can read *Use of `Send()` vs. `SendTo()`* for details on how to set the packet priority. If a packet is classified by an installed packet filter and the returned value `i` is non-negative and less than the number of priority bands, then the packet is enqueued into the `i`-th priority band. Otherwise, the packet is enqueued into the priority band specified by the first element of the `priomap` array.

If no queue disc class is added by the user before the queue disc is initialized, three child queue discs of type `FifoQueueDisc` are automatically added. It has to be noted that `PrioQueueDisc` needs at least two child queue discs.

## Attributes

The `PrioQueueDisc` class holds the following attribute:

- `Priomap`: The priority to band mapping. The default value is the same mapping as the (fixed) one used by `PfifoFastQueueDisc`.

## Examples

An example of how to configure `PrioQueueDisc` with custom child queue discs and priomap is provided by `queue-discs-benchmark.cc` located in `examples/traffic-control`:

```
TrafficControlHelper tch;
uint16_t handle = tch.SetRootQueueDisc ("ns3::PrioQueueDisc", "Priomap", StringValue (
↪ "0 1 0 1 0 1 0 1 0 1 0 1 0 1 0 1"));
TrafficControlHelper::ClassIdList cid = tch.AddQueueDiscClasses (handle, 2,
↪ "ns3::QueueDiscClass");
tch.AddChildQueueDisc (handle, cid[0], "ns3::FifoQueueDisc");
tch.AddChildQueueDisc (handle, cid[1], "ns3::RedQueueDisc");
```

The code above adds two classes (bands) to a `PrioQueueDisc`. The highest priority one is a `FifoQueueDisc`, the other one is a `RedQueueDisc`. The attribute `Priomap` is set to an array containing only 0 and 1 (since `PrioQueueDisc` only has two bands).

### 32.5.2 Validation

`PrioQueueDisc` is tested using `PrioQueueDiscTestSuite` class defined in `src/traffic-control/test/prio-queue-disc-test-suite.cc`. The test aims to check that: i) packets are enqueued in the correct band based on their priority and the priomap or according to the value returned by the installed packet filter; ii) packets are dequeued in the correct order.

The test suite can be run using the following commands:

```
$ ./waf configure --enable-examples --enable-tests
$ ./waf build
$ ./test.py -s prio-queue-disc
```

or

```
$ NS_LOG="PrioQueueDisc" ./waf --run "test-runner --suite=prio-queue-disc"
```

## 32.6 TBF queue disc

This chapter describes the TBF ([Ref1]) queue disc implementation in *ns-3*. The TBF model in *ns-3* is ported based on Linux kernel code implemented by A. Kuznetsov and D. Torokhov.

TBF is a `qdisc` that allows controlling the bandwidth of the output according to a set rate with the possibility of managing burst conditions also. The TBF implementation consists of a bucket (buffer) having a limited capacity into which tokens (normally representing a unit of bytes or a single packet of predetermined size) are added at a fixed rate 'r' called the token rate. Whenever a packet arrives into the tx queue (fifo by default), the bucket is checked to see if there are appropriate number of tokens that is equivalent to the length of the packet in bytes. If yes, then the tokens are removed and the packet is passed for transmission. If no, then packets will have to wait until there are sufficient tokens in the bucket. This data conformance can be thus put into three possible scenarios [Ref3]:

1. Data rate = Token rate : Packets pass without delay.
2. Data rate < Token rate : The tokens might accumulate and the bucket might become full. Then, the next packets to enter TBF will be transmitted right away without having any limit applied to them, until the bucket is empty. This is called a burst condition and in TBF the burst parameter defines the size of the bucket. In order to overcome this problem and provide better control over the bursts, TBF implements a second bucket which is smaller and generally the same size as the MTU. This second bucket cannot store large amount of tokens, but

its replenishing rate will be a lot faster than the one of the big bucket. This second rate is called 'peakRate' and it will determine the maximum rate of a burst.

3. Data rate > Token rate : This causes the TBF algorithm to throttle itself for a while as soon as the bucket gets empty. This is called an 'overlimit situation' [Ref2]. In this situation, some of the packets will be blocked until enough tokens are available at which time a schedule for the waking of the queue will be done. If packets keep coming in, at a larger rate, then the packets will start to get dropped when the total number of bytes exceeds the QueueLimit.

### 32.6.1 Model Description

The TBF queue disc does not require packet filters, does not admit internal queues and uses a single child queue disc. If the user does not provide a child queue disc, a Fifo queue disc operating in the same mode (packet or byte) as the TBF queue disc and having a size equal to the TBF QueueLimit attribute is created. Otherwise, the capacity of the TBF queue disc is determined by the capacity of the child queue disc.

There are two token buckets: first bucket and second bucket. The size of the first bucket called 'Burst' should always be greater than the size of the second bucket called the Mtu (which is usually the size of a single packet). But the 'PeakRate' which is the second bucket's token rate should be always greater than the 'Rate' which is the first bucket's token rate.

If the PeakRate is zero, then the second bucket does not exist. In order to activate the second bucket, both the Mtu and PeakRate values have to be greater than zero. If the Mtu value is zero at initialization time, then if a NetDevice exists, the Mtu's value will be equal to the Mtu of the NetDevice. But if no NetDevice exists, then the QueueDisc will complain thus prompting the user to set the Mtu value.

The source code for the TBF model is located in the directory `src/traffic-control/model` and consists of 2 files `tbf-queue-disc.h` and `tbf-queue-disc.cc` defining a `TbfQueueDisc` class.

- class `TbfQueueDisc`: This class implements the main TBF algorithm:
  - `TbfQueueDisc::DoEnqueue ()`: This routine enqueue's the incoming packet if the queue is not full and drops the packet otherwise.
  - `TbfQueueDisc::DoPeek ()`: This routine peeks for the top item in the queue and if the queue is not empty, it returns the topmost item.
  - `TbfQueueDisc::DoDequeue ()`: This routine performs the dequeuing of packets according to the following logic:
    - \* It calls `TbfQueueDisc::Peek ()` and calculates the size of the packet to be dequeued in bytes.
    - \* Then it calculates the time difference 'delta', which is the time elapsed since the last update of tokens in the buckets.
    - \* If the second bucket exists, the number of tokens are updated according to the 'PeakRate' and 'delta'.
    - \* From this second bucket a number of tokens equal to the size of the packet to be dequeued is subtracted.
    - \* Now the number of tokens in the first bucket are updated according to 'Rate' and 'delta'.
    - \* From this first bucket a number of tokens equal to the size of the packet to be dequeued is subtracted.
    - \* If after this, both the first and second buckets have tokens greater than zero, then the packet is dequeued.
    - \* Else, an event to `QueueDisc::Run ()` is scheduled after a time period when enough tokens will be present for the dequeue operation.

## References

### Attributes

The key attributes that the `TbfQueueDisc` class holds include the following:

- `MaxSize`: The maximum number of packets/bytes the queue disc can hold. The default value is 1000 packets.
- `Burst`: Size of the first bucket, in bytes. The default value is 125000 bytes.
- `Mtu`: Size of second bucket defaults to the MTU of the attached `NetDevice`, if any, or 0 otherwise.
- `Rate`: Rate at which tokens enter the first bucket. The default value is 125KB/s.
- `PeakRate`: Rate at which tokens enter the second bucket. The default value is 0KB/s, which means that there is no second bucket.

### TraceSources

The `TbfQueueDisc` class provides the following trace sources:

- `TokensInFirstBucket`: Number of First Bucket Tokens in bytes
- `TokensInSecondBucket`: Number of Second Bucket Tokens in bytes

### Examples

The example for TBF is `tb-example.cc` located in `examples/traffic-control/`. The command to run the file (the invocation below shows the available command-line options) is:

```
.. sourcecode:: bash

$ ./waf --run "tb-example --PrintHelp" $ ./waf --run "tb-example --burst=125000 --rate=1Mbps
--peakRate=1.5Mbps"
```

The expected output from the previous commands are traced value changes in the number of tokens in the first and second buckets.

## 32.6.2 Validation

The TBF model is tested using `TbfQueueDiscTestSuite` class defined in `src/traffic-control/test/tbf-queue-disc-test-suite.cc`. The suite includes 4 test cases:

- Test 1: Simple Enqueue/Dequeue with verification of attribute setting and subtraction of tokens from the buckets.
- Test 2: When `DataRate == FirstBucketTokenRate`; packets should pass smoothly.
- Test 3: When `DataRate >>> FirstBucketTokenRate`; some packets should get blocked and waking of queue should get scheduled.
- Test 4: When `DataRate < FirstBucketTokenRate`; burst condition, `peakRate` is set so that bursts are controlled.

The test suite can be run using the following commands:

```
.. sourcecode:: bash

$ ./waf configure --enable-examples --enable-tests $ ./waf build $ ./test.py -s tbf-queue-disc
```

or

```
.. sourcecode:: bash
```

```
$ NS_LOG="TbfQueueDisc" ./waf --run "test-runner --suite=tbf-queue-disc"
```

## 32.7 RED queue disc

### 32.7.1 Model Description

Random Early Detection (RED) is a queue discipline that aims to provide early signals to transport protocol congestion control (e.g. TCP) that congestion is imminent, so that they back off their rate gracefully rather than with a bunch of tail-drop losses (possibly incurring TCP timeout). The model in ns-3 is a port of Sally Floyd's ns-2 RED model.

Note that, starting from ns-3.25, RED is no longer a queue variant and cannot be installed as a NetDevice queue. Instead, RED is a queue disc and must be installed in the context of the traffic control (see the examples mentioned below).

The RED queue disc does not require packet filters, does not admit child queue discs and uses a single internal queue. If not provided by the user, a DropTail queue operating in the same mode (packet or byte) as the queue disc and having a size equal to the RED MaxSize attribute is created. Otherwise, the capacity of the queue disc is determined by the capacity of the internal queue provided by the user.

#### Adaptive Random Early Detection (ARED)

ARED is a variant of RED with two main features: (i) automatically sets Queue weight, MinTh and MaxTh and (ii) adapts maximum drop probability. The model in ns-3 contains implementation of both the features, and is a port of Sally Floyd's ns-2 ARED model. Note that the user is allowed to choose and explicitly configure the simulation by selecting feature (i) or feature (ii), or both.

#### Feng's Adaptive RED

Feng's Adaptive RED is a variant of RED that adapts the maximum drop probability. The model in ns-3 contains implementation of this feature, and is a port of ns-2 Feng's Adaptive RED model.

#### Nonlinear Random Early Detection (NLRED)

NLRED is a variant of RED in which the linear packet dropping function of RED is replaced by a nonlinear quadratic function. This approach makes packet dropping gentler for light traffic load and aggressive for heavy traffic load.

#### Explicit Congestion Notification (ECN)

This RED model supports an ECN mode of operation to notify endpoints of congestion that may be developing in a bottleneck queue, without resorting to packet drops. Such a mode is enabled by setting the UseEcn attribute to true (it is false by default) and only affects incoming packets with the ECT bit set in their header. When the average queue length is between the minimum and maximum thresholds, an incoming packet is marked instead of being dropped. When the average queue length is above the maximum threshold, an incoming packet is marked (instead of being dropped) only if the UseHardDrop attribute is set to false (it is true by default).

The implementation of support for ECN marking is done in such a way as to not impose an internet module dependency on the traffic control module. The RED model does not directly set ECN bits on the header, but delegates that job to

the `QueueDiscItem` class. As a result, it is possible to use RED queues for other non-IP `QueueDiscItems` that may or may not support the `Mark ()` method.

### References

The RED queue disc aims to be close to the results cited in: S.Floyd, K.Fall <http://icir.org/floyd/papers/reddims.ps>

ARED queue implementation is based on the algorithm provided in: S. Floyd et al, <http://www.icir.org/floyd/papers/adaptiveRed.pdf>

Feng's Adaptive RED queue implementation is based on the algorithm provided in: W. C. Feng et al, <http://ieeexplore.ieee.org/stamp/stamp.jsp?arnumber=752150>

NLRED queue implementation is based on the algorithm provided in: Kaiyu Zhou et al, <http://www.sciencedirect.com/science/article/pii/S1389128606000879>

The addition of explicit congestion notification (ECN) to IP: K. K. Ramakrishnan et al, <https://tools.ietf.org/html/rfc3168>

### Attributes

The RED queue contains a number of attributes that control the RED policies:

- `MaxSize`
- `MeanPktSize`
- `IdlePktSize`
- `Wait (time)`
- `Gentle mode`
- `MinTh, MaxTh`
- `Queue weight`
- `LInterm`
- `LinkBandwidth`
- `LinkDelay`
- `UseEcn`
- `UseHardDrop`

In addition to RED attributes, ARED queue requires following attributes:

- `ARED` (Boolean attribute. Default: false)
- `AdaptMaxP` (Boolean attribute to adapt `m_curMaxP`. Default: false)
- `Target Delay (time)`
- `Interval (time)`
- `LastSet (time)`
- `Top` (upper limit of `m_curMaxP`)
- `Bottom` (lower limit of `m_curMaxP`)
- `Alpha` (increment parameter for `m_curMaxP`)
- `Beta` (decrement parameter for `m_curMaxP`)

- RTT

In addition to RED attributes, Feng's Adaptive RED queue requires following attributes:

- FengAdaptive (Boolean attribute, Default: false)
- Status (status of current queue length, Default: Above)
- FengAlpha (increment parameter for `m_curMaxP`, Default: 3)
- FengBeta (decrement parameter for `m_curMaxP`, Default: 2)

The following attribute should be turned on to simulate NLRED queue disc:

- NLRED (Boolean attribute. Default: false)

Consult the ns-3 documentation for explanation of these attributes.

### Simulating ARED

To switch on ARED algorithm, the attribute ARED must be set to true, as done in `src/traffic-control/examples/adaptive-red-tests.cc`:

```
Config::SetDefault ("ns3::RedQueueDisc::ARED", BooleanValue (true));
```

Setting ARED to true implicitly configures both: (i) automatic setting of Queue weight, MinTh and MaxTh and (ii) adapting `m_curMaxP`.

NOTE: To explicitly configure (i) or (ii), set ARED attribute to false and follow the procedure described next:

To configure (i); Queue weight, MinTh and MaxTh, all must be set to 0, as done in `src/traffic-control/examples/adaptive-red-tests.cc`:

```
Config::SetDefault ("ns3::RedQueueDisc::QW", DoubleValue (0.0));
Config::SetDefault ("ns3::RedQueueDisc::MinTh", DoubleValue (0));
Config::SetDefault ("ns3::RedQueueDisc::MaxTh", DoubleValue (0));
```

To configure (ii); `AdaptMaxP` must be set to true, as done in `src/traffic-control/examples/adaptive-red-tests.cc`:

```
Config::SetDefault ("ns3::RedQueueDisc::AdaptMaxP", BooleanValue (true));
```

### Simulating Feng's Adaptive RED

To switch on Feng's Adaptive RED algorithm, the attribute FengAdaptive must be set to true, as done in `examples/traffic-control/red-vs-fengadaptive.cc`:

```
Config::SetDefault ("ns3::RedQueueDisc::FengAdaptive", BooleanValue (true));
```

### Simulating NLRED

To switch on NLRED algorithm, the attribute NLRED must be set to true, as shown below:

```
Config::SetDefault ("ns3::RedQueueDisc::NLRED", BooleanValue (true));
```

## Examples

The RED queue example is found at `src/traffic-control/examples/red-tests.cc`.

ARED queue examples can be found at: `src/traffic-control/examples/adaptive-red-tests.cc` and `src/traffic-control/examples/red-vs-ared.cc`

Feng's Adaptive RED example can be found at: `examples/traffic-control/red-vs-fengadaptive.cc`

NLRED queue example can be found at: `examples/traffic-control/red-vs-nlred.cc`

### 32.7.2 Validation

The RED model has been validated and the report is currently stored at: <https://github.com/downloads/talau/ns-3-tcp-red/report-red-ns3.pdf>

## 32.8 CoDel queue disc

This chapter describes the CoDel ([Nic12], [Nic14]) queue disc implementation in *ns-3*.

Developed by Kathleen Nichols and Van Jacobson as a solution to the bufferbloat [Buf14] problem, CoDel (Controlled Delay Management) is a queuing discipline that uses a packet's sojourn time (time in queue) to make decisions on packet drops.

Note that, starting from ns-3.25, CoDel is no longer a queue variant and cannot be installed as a NetDevice queue. Instead, CoDel is a queue disc and must be installed in the context of the traffic control (see the examples mentioned below).

### 32.8.1 Model Description

The source code for the CoDel model is located in the directory `src/traffic-control/model` and consists of 2 files `codel-queue-disc.h` and `codel-queue-disc.cc` defining a `CoDelQueueDisc` class and a helper `CoDelTimestampTag` class. The code was ported to *ns-3* by Andrew McGregor based on Linux kernel code implemented by Dave Täht and Eric Dumazet.

- `class CoDelQueueDisc`: This class implements the main CoDel algorithm:
  - `CoDelQueueDisc::DoEnqueue ()`: This routine tags a packet with the current time before pushing it into the queue. The timestamp tag is used by `CoDelQueue::DoDequeue ()` to compute the packet's sojourn time. If the queue is full upon the packet arrival, this routine will drop the packet and record the number of drops due to queue overflow, which is stored in `m_dropOverLimit`.
  - `CoDelQueueDisc::ShouldDrop ()`: This routine is `CoDelQueueDisc::DoDequeue ()`'s helper routine that determines whether a packet should be dropped or not based on its sojourn time. If the sojourn time goes above `m_target` and remains above continuously for at least `m_interval`, the routine returns `true` indicating that it is OK to drop the packet. Otherwise, it returns `false`.
  - `CoDelQueueDisc::DoDequeue ()`: This routine performs the actual packet drop based on `CoDelQueueDisc::ShouldDrop ()`'s return value and schedules the next drop/mark.
- `class CoDelTimestampTag`: This class implements the timestamp tagging for a packet. This tag is used to compute the packet's sojourn time (the difference between the time the packet is dequeued and the time it is pushed into the queue).

There are 2 branches to `CoDelQueueDisc::DoDequeue ()`:



1. If the queue is currently in the dropping state, which means the sojourn time has remained above *m\_target* for more than *m\_interval*, the routine determines if it's OK to leave the dropping state or it's time for the next drop/mark. When `CoDelQueueDisc::ShouldDrop ()` returns `false`, the queue can move out of the dropping state (set *m\_dropping* to `false`). Otherwise, the queue continuously drops/marks packets and updates the time for next drop (*m\_dropNext*) until one of the following conditions is met:
  1. The queue is empty, upon which the queue leaves the dropping state and exits `CoDelQueueDisc::ShouldDrop ()` routine;
  2. `CoDelQueueDisc::ShouldDrop ()` returns `false` (meaning the sojourn time goes below *m\_target*) upon which the queue leaves the dropping state;
  3. It is not yet time for next drop/mark (*m\_dropNext* is less than current time) upon which the queue waits for the next packet dequeue to check the condition again.
2. If the queue is not in the dropping state, the routine enters the dropping state and drop/mark the first packet if `CoDelQueueDisc::ShouldDrop ()` returns `true` (meaning the sojourn time has gone above *m\_target* for at least *m\_interval* for the first time or it has gone above again after the queue leaves the dropping state).

The CoDel queue disc does not require packet filters, does not admit child queue discs and uses a single internal queue. If not provided by the user, a DropTail queue operating in the same mode (packet or byte) as the queue disc and having a size equal to the CoDel MaxSize attribute is created. Otherwise, the capacity of the queue disc is determined by the capacity of the internal queue provided by the user.

## References

## Attributes

The key attributes that the CoDelQueue class holds include the following:

- `MaxSize`: The maximum number of packets/bytes the queue can hold. The default value is `1500 * DEFAULT_CODEL_LIMIT`, which is `1500 * 1000` bytes.
- `MinBytes`: The CoDel algorithm minbytes parameter. The default value is 1500 bytes.
- `Interval`: The sliding-minimum window. The default value is 100 ms.
- `Target`: The CoDel algorithm target queue delay. The default value is 5 ms.
- `UseEcn`: True to use ECN (packets are marked instead of being dropped). The default value is false.
- `CeThreshold`: The CoDel CE threshold for marking packets. Disabled by default.

## Examples

The first example is `codel-vs-pfifo-basic-test.cc` located in `src/traffic-control/examples`. To run the file (the first invocation below shows the available command-line options):

```
$ ./waf --run "codel-vs-pfifo-basic-test --PrintHelp"
$ ./waf --run "codel-vs-pfifo-basic-test --queueType=CoDel --pcapFileName=codel.pcap -
↪-cwndTrFileName=cwndCodel.tr"
```

The expected output from the previous commands are two files: `codel.pcap` file and `cwndCoDel.tr` (ASCII trace) file. The `.pcap` file can be analyzed using Wireshark or `tcptrace`:

```
$ tcptrace -l -r -n -W codel.pcap
```

The second example is `codel-vs-pfifo-asymmetric.cc` located in `src/traffic-control/examples`. This example is intended to model a typical cable modem deployment scenario. To run the file:

```
$ ./waf --run "codel-vs-pfifo-asymmetric --PrintHelp"  
$ ./waf --run codel-vs-pfifo-asymmetric
```

The expected output from the previous commands is six pcap files:

- codel-vs-pfifo-asymmetric-CoDel-server-lan.pcap
- codel-vs-pfifo-asymmetric-CoDel-router-wan.pcap
- codel-vs-pfifo-asymmetric-CoDel-router-lan.pcap
- codel-vs-pfifo-asymmetric-CoDel-cmts-wan.pcap
- codel-vs-pfifo-asymmetric-CoDel-cmts-lan.pcap
- codel-vs-pfifo-asymmetric-CoDel-host-lan.pcap

One attribute file:

- codel-vs-pfifo-asymmetric-CoDel.attr

Five ASCII trace files:

- codel-vs-pfifo-asymmetric-CoDel-drop.tr
- codel-vs-pfifo-asymmetric-CoDel-drop-state.tr
- codel-vs-pfifo-asymmetric-CoDel-sojourn.tr
- codel-vs-pfifo-asymmetric-CoDel-length.tr
- codel-vs-pfifo-asymmetric-CoDel-cwnd.tr

## 32.8.2 Validation

The CoDel model is tested using `CoDelQueueDiscTestSuite` class defined in `src/traffic-control/test/codel-queue-test-suite.cc`. The suite includes 5 test cases:

- Test 1: The first test checks the enqueue/dequeue with no drops and makes sure that CoDel attributes can be set correctly.
- Test 2: The second test checks the enqueue with drops due to queue overflow.
- Test 3: The third test checks the `NewtonStep()` arithmetic against explicit port of Linux implementation
- Test 4: The fourth test checks the `ControlLaw()` against explicit port of Linux implementation
- Test 5: The fifth test checks the enqueue/dequeue with drops according to CoDel algorithm
- Test 6: The sixth test checks the enqueue/dequeue with marks according to CoDel algorithm

The test suite can be run using the following commands:

```
$ ./waf configure --enable-examples --enable-tests  
$ ./waf build  
$ ./test.py -s codel-queue-disc
```

or

```
$ NS_LOG="CoDelQueueDisc" ./waf --run "test-runner --suite=codel-queue-disc"
```

## 32.9 FqCoDel queue disc

This chapter describes the FqCoDel ([Hoe16]) queue disc implementation in *ns-3*.

The FlowQueue-CoDel (FQ-CoDel) algorithm is a combined packet scheduler and Active Queue Management (AQM) algorithm developed as part of the bufferbloat-fighting community effort ([Buf16]). FqCoDel classifies incoming packets into different queues (by default, 1024 queues are created), which are served according to a modified Deficit Round Robin (DRR) queue scheduler. Each queue is managed by the CoDel AQM algorithm. FqCoDel distinguishes between “new” queues (which don’t build up a standing queue) and “old” queues, that have queued enough data to be around for more than one iteration of the round-robin scheduler.

FqCoDel is installed by default on single-queue NetDevices (such as PointToPoint, Csma and Simple). Also, on multi-queue devices (such as Wifi), the default root qdisc is Mq with as many FqCoDel child queue discs as the number of device queues.

### 32.9.1 Model Description

The source code for the FqCoDel queue disc is located in the directory `src/traffic-control/model` and consists of 2 files `fq-codel-queue-disc.h` and `fq-codel-queue-disc.cc` defining a `FqCoDelQueueDisc` class and a helper `FqCoDelFlow` class. The code was ported to *ns-3* based on Linux kernel code implemented by Eric Dumazet. Set associative hashing is also based on the Linux kernel [CAKE](#) queue management code. Set associative hashing is used to reduce the number of hash collisions in comparison to choosing queues normally with a simple hash. For a given number of queues, set associative hashing has fewer collisions than a traditional hash, as long as the number of flows is lesser than the number of queues. Essentially, it makes the queue management system more efficient. Set associative hashing is a vital component of CAKE, which is another popular flow management algorithm that is implemented in Linux and is being tested for FqCoDel. Furthermore, this module can be directly used with CAKE when its other components are implemented in *ns-3*. The only changes needed to incorporate this new hashing scheme are in the `SetAssociativeHash` and `DoEnqueue` methods, as described below.

- `class FqCoDelQueueDisc`: This class implements the main FqCoDel algorithm:
  - `FqCoDelQueueDisc::DoEnqueue()`: If no packet filter has been configured, this routine calls the `QueueDiscItem::Hash()` method to classify the given packet into an appropriate queue. Otherwise, the configured filters are used to classify the packet. If the filters are unable to classify the packet, the packet is dropped. Otherwise, an option is provided if set associative hashing is to be used. The packet is now handed over to the CoDel algorithm for timestamping. Then, if the queue is not currently active (i.e., if it is not in either the list of new or the list of old queues), it is added to the end of the list of new queues, and its deficit is initiated to the configured quantum. Otherwise, the queue is left in its current queue list. Finally, the total number of enqueued packets is compared with the configured limit, and if it is above this value (which can happen since a packet was just enqueued), packets are dropped from the head of the queue with the largest current byte count until the number of dropped packets reaches the configured drop batch size or the backlog of the queue has been halved. Note that this in most cases means that the packet that was just enqueued is not among the packets that get dropped, which may even be from a different queue.
  - `FqCoDelQueueDisc::SetAssociativeHash()`: An outer hash is identified for the given packet. This corresponds to the set into which the packet is to be enqueued. A set consists of a group of queues. The set determined by outer hash is enumerated; if a queue corresponding to this packet’s flow is found (we use per-queue tags to achieve this), or in case of an inactive queue, or if a new queue can be created for this set without exceeding the maximum limit, the index of this queue is returned. Otherwise, all queues of this full set are active and correspond to flows different from the current packet’s flow. In such cases, the index of first queue of this set is returned. We don’t consider creating new queues for the packet in these cases, since this approach may waste resources in the long run. The situation highlighted is a guaranteed collision and cannot be avoided without increasing the overall number of queues.

- `FqCoDelQueueDisc::DoDequeue ()`: The first task performed by this routine is selecting a queue from which to dequeue a packet. To this end, the scheduler first looks at the list of new queues; for the queue at the head of that list, if that queue has a negative deficit (i.e., it has already dequeued at least a quantum of bytes), it is given an additional amount of deficit, the queue is put onto the end of the list of old queues, and the routine selects the next queue and starts again. Otherwise, that queue is selected for dequeue. If the list of new queues is empty, the scheduler proceeds down the list of old queues in the same fashion (checking the deficit, and either selecting the queue for dequeuing, or increasing deficit and putting the queue back at the end of the list). After having selected a queue from which to dequeue a packet, the CoDel algorithm is invoked on that queue. As a result of this, one or more packets may be discarded from the head of the selected queue, before the packet that should be dequeued is returned (or nothing is returned if the queue is or becomes empty while being handled by the CoDel algorithm). Finally, if the CoDel algorithm does not return a packet, then the queue must be empty, and the scheduler does one of two things: if the queue selected for dequeue came from the list of new queues, it is moved to the end of the list of old queues. If instead it came from the list of old queues, that queue is removed from the list, to be added back (as a new queue) the next time a packet for that queue arrives. Then (since no packet was available for dequeue), the whole dequeue process is restarted from the beginning. If, instead, the scheduler did get a packet back from the CoDel algorithm, it subtracts the size of the packet from the byte deficit for the selected queue and returns the packet as the result of the dequeue operation.
- `FqCoDelQueueDisc::FqCoDelDrop ()`: This routine is invoked by `FqCoDelQueueDisc::DoEnqueue ()` to drop packets from the head of the queue with the largest current byte count. This routine keeps dropping packets until the number of dropped packets reaches the configured drop batch size or the backlog of the queue has been halved.
- `class FqCoDelFlow`: This class implements a flow queue, by keeping its current status (whether it is in the list of new queues, in the list of old queues or inactive) and its current deficit.

In Linux, by default, packet classification is done by hashing (using a Jenkins hash function) the 5-tuple of IP protocol, source and destination IP addresses and port numbers (if they exist). This value modulo the number of queues is salted by a random value selected at initialization time, to prevent possible DoS attacks if the hash is predictable ahead of time. Alternatively, any other packet filter can be configured. In *ns-3*, packet classification is performed in the same way as in Linux. Neither internal queues nor classes can be configured for an FqCoDel queue disc.

## Possible next steps

- what to do if ECT(1) and either/both ECT(0) and NotECT are in the same flow queue (hash collisions or tunnels)– our L4S traffic flows will avoid this situation by supporting AccECN and ECN++ (and if it happens in practice, the CoDel logic will just apply two separate thresholds)
- adding a ramp marking response instead of step threshold
- adding a floor value (to suppress marks if the queue length is below a certain number of bytes or packets)
- adding a heuristic such as in PIE to avoid marking a packet if it arrived to an empty flow queue (check on ingress, remember at egress time)

## References

### Attributes

The key attributes that the `FqCoDelQueue` class holds include the following:

- `UseEcn`: True to use ECN (packets are marked instead of being dropped)
- `Interval`: The interval parameter to be used on the CoDel queues. The default value is 100 ms.
- `Target`: The target parameter to be used on the CoDel queues. The default value is 5 ms.

- `MaxSize`: The limit on the maximum number of packets stored by `FqCoDel`.
- `Flows`: The number of flow queues managed by `FqCoDel`.
- `DropBatchSize`: The maximum number of packets dropped from the fat flow.
- `Perturbation`: The salt used as an additional input to the hash function used to classify packets.
- `CeThreshold`: The `FqCoDel` CE threshold for marking packets
- `UseL4s`: True to use L4S (only ECT1 packets are marked at CE threshold)
- `EnableSetAssociativeHash`: The parameter used to enable set associative hash.

`Perturbation` is an optional configuration attribute and can be used to generate different hash outcomes for different inputs. For instance, the tuples used as input to the hash may cause hash collisions (mapping to the same bucket) for a given set of inputs, but by changing the `Perturbation` value, the same hash inputs now map to distinct buckets.

Note that the quantum, i.e., the number of bytes each queue gets to dequeue on each round of the scheduling algorithm, is set by default to the MTU size of the device (at initialisation time). The `FqCoDelQueueDisc::SetQuantum ()` method can be used (at any time) to configure a different value.

## Examples

A typical usage pattern is to create a traffic control helper and to configure type and attributes of queue disc and filters from the helper. For example, `FqCodel` can be configured as follows:

```
TrafficControlHelper tch;
tch.SetRootQueueDisc ("ns3::FqCoDelQueueDisc", "DropBatchSize", UintegerValue (1)
                    "Perturbation", UintegerValue (256));
QueueDiscContainer qdiscs = tch.Install (devices);
```

The example for `FqCoDel`'s L4S mode is `FqCoDel-L4S-example.cc` located in `src/traffic-control/examples`. To run the file (the first invocation below shows the available command-line options): `.. sourcecode:: bash`

```
$ ./waf --run "FqCoDel-L4S-example --PrintHelp" $ ./waf --run "FqCoDel-L4S-example --scenarioNum=5"
```

The expected output from the previous command are `.dat` files.

## 32.9.2 Validation

The `FqCoDel` model is tested using `FqCoDelQueueDiscTestSuite` class defined in `src/test/ns3tc/codel-queue-test-suite.cc`. The suite includes 5 test cases:

- Test 1: The first test checks that packets that cannot be classified by any available filter are dropped.
- Test 2: The second test checks that IPv4 packets having distinct destination addresses are enqueued into different flow queues. Also, it checks that packets are dropped from the fat flow in case the queue disc capacity is exceeded.
- Test 3: The third test checks the dequeue operation and the deficit round robin-based scheduler.
- Test 4: The fourth test checks that TCP packets with distinct port numbers are enqueued into different flow queues.
- Test 5: The fifth test checks that UDP packets with distinct port numbers are enqueued into different flow queues.
- Test 6: The sixth test checks that the packets are marked correctly.

- Test 7: The seventh test checks the working of set associative hashing and its linear probing capabilities by using TCP packets with different hashes enqueued into different sets and queues.
- Test 8: The eighth test checks the L4S mode of FqCoDel where ECT1 packets are marked at CE threshold (target delay does not matter) while ECT0 packets continue to be marked at target delay (CE threshold does not matter).

The test suite can be run using the following commands:

```
$ ./waf configure --enable-examples --enable-tests  
$ ./waf build  
$ ./test.py -s fq-codel-queue-disc
```

or:

```
$ NS_LOG="FqCoDelQueueDisc" ./waf --run "test-runner --suite=fq-codel-queue-disc"
```

Set associative hashing is tested by generating a probability collision graph. This graph is then overlapped with the theoretical graph provided in the original CAKE paper (refer to Figure 1 from CAKE). The generated graph is linked below:

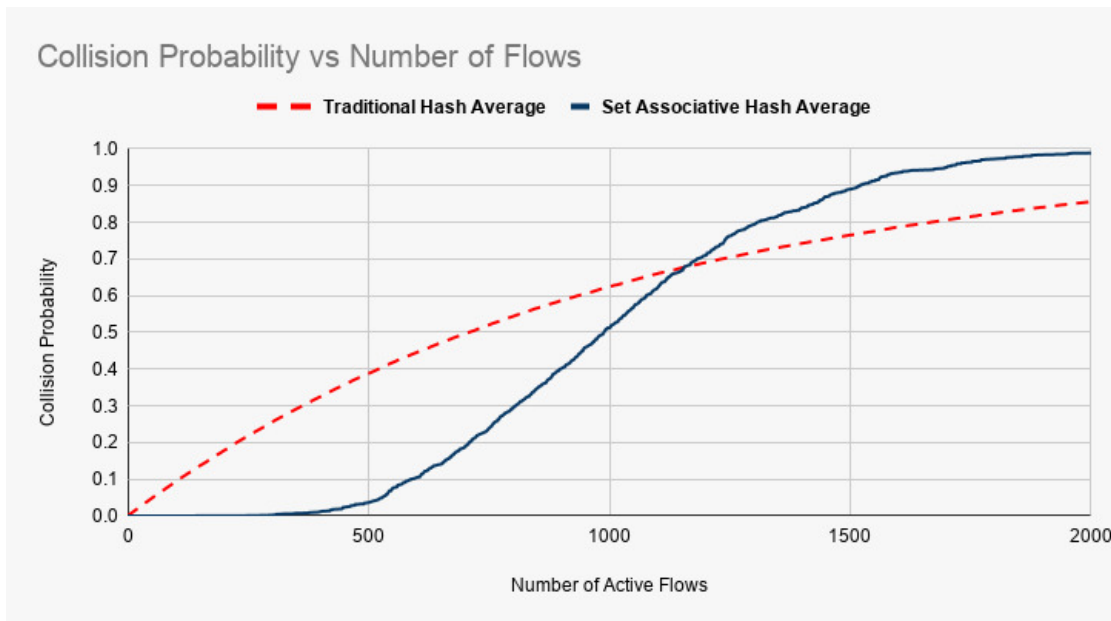

**alt** Generated Collision Probability Graph

The overlapped graph is also linked below:

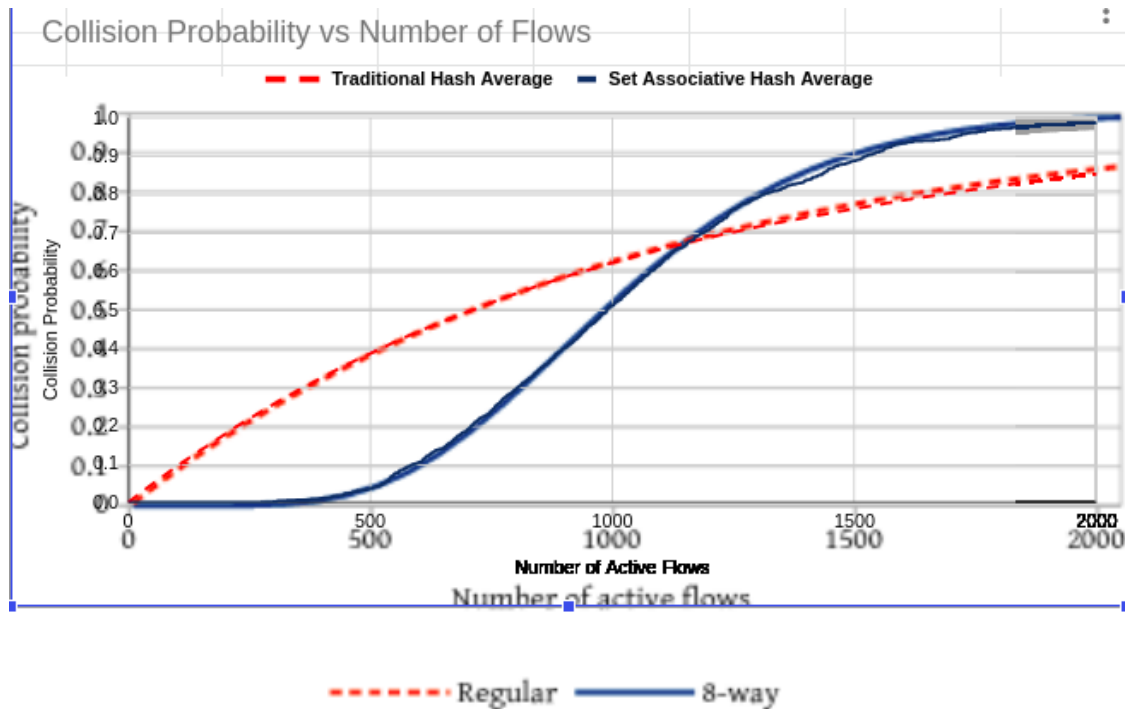

**alt** Overlapped Image with the graph from CAKE paper

The steps to replicate this graph are available on this [link](#).

## 32.10 Cobalt queue disc

This chapter describes the COBALT (CoDel BLUE Alternate) ([Cake16]) queue disc implementation in *ns-3*.

COBALT queue disc is an integral component of CAKE smart queue management system. It is a combination of the CoDel ([Kath17]) and BLUE ([BLUE02]) Active Queue Management algorithms.

### 32.10.1 Model Description

The source code for the COBALT model is located in the directory `src/traffic-control/model` and consists of 2 files: `cobalt-queue-disc.h` and `cobalt-queue-disc.cc` defining a `CobaltQueueDisc` class and a helper `CobaltTimestampTag` class. The code was ported to *ns-3* by Vignesh Kanan, Harsh Lara, Shefali Gupta, Jendaipou Palmei and Mohit P. Tahiliani based on the Linux kernel code.

Stefano Avallone and Pasquale Imputato helped in verifying the correctness of COBALT model in *ns-3* by comparing the results obtained from it to those obtained from the Linux model of COBALT. A detailed comparison of *ns-3* model of COBALT with Linux model of COBALT is provided in ([Cobalt19]).

- `class CobaltQueueDisc`: This class implements the main Cobalt algorithm:
- `CobaltQueueDisc::DoEnqueue ()`: This routine tags a packet with the current time before pushing it into the queue. The timestamp tag is used by `CobaltQueue::DoDequeue ()` to compute the packet's sojourn time. If the queue is full upon the packet arrival, this routine will drop the packet and record the number of drops due to queue overflow, which is stored in `m_stats.qLimDrop`.
- `CobaltQueueDisc::ShouldDrop ()`: This routine is `CobaltQueueDisc::DoDequeue ()`'s helper routine that determines whether a packet should be dropped or not based on its sojourn time. If the sojourn time goes above `m_target` and remains above continuously for at least `m_interval`, the routine returns `true` indicating that

it is OK to drop the packet. Otherwise, it returns `false`. This routine decides if a packet should be dropped based on the dropping state of CoDel and drop probability of BLUE. The idea is to have both algorithms running in parallel and their effectiveness is decided by their respective parameters (Pdrop of BLUE and dropping state of CoDel). If either of them decide to drop the packet, the packet is dropped.

- `CobaltQueueDisc::DoDequeue ()`: This routine performs the actual packet drop based on `CobaltQueueDisc::ShouldDrop ()`'s return value and schedules the next drop. Cobalt will decrease BLUE's drop probability if the queue is empty. This will ensure that the queue does not underflow. Otherwise Cobalt will take the next packet from the queue and calculate its drop state by running CoDel and BLUE in parallel till there are none left to drop.
- `class CobaltTimestampTag`: This class implements the timestamp tagging for a packet. This tag is used to compute the packet's sojourn time (the difference between the time the packet is dequeued and the time it is pushed into the queue).

## References

### Attributes

The key attributes that the `CobaltQueue Disc` class holds include the following:

- `MaxSize`: The maximum number of packets/bytes accepted by this queue disc.
- `Interval`: The sliding-minimum window. The default value is 100 ms.
- `Target`: The Cobalt algorithm target queue delay. The default value is 5 ms.
- `Pdrop`: Value of drop probability.
- `Increment`: Increment value of drop probability. Default value is  $1./256$ .
- `Decrement`: Decrement value of drop probability. Default value is  $1./4096$ .
- `Count`: Cobalt count.
- `DropState`: Dropping state of Cobalt. Default value is false.
- `Sojourn`: Per packet time spent in the queue.
- `DropNext`: Time until next packet drop.

### Examples

An example program named `cobalt-vs-codel.cc` is located in `src/traffic-control/examples`. Use the following command to run the program.

```
$ ./waf --run cobalt-vs-codel
```

## 32.10.2 Validation

The COBALT model is tested using `CobaltQueueDiscTestSuite` class defined in `src/traffic-control/test/cobalt-queue-test-suite.cc`. The suite includes 2 test cases:

- Test 1: Simple enqueue/dequeue with no drops.
- Test 2: Change of BLUE's drop probability upon queue full (Activation of Blue).
- Test 3: Test for ECN marking of packets



The test suite can be run using the following commands:

```
$ ./waf configure --enable-examples --enable-tests
$ ./waf build
$ ./test.py -s cobalt-queue-disc
```

or

```
$ NS_LOG="CobaltQueueDisc" ./waf --run "test-runner --suite=cobalt-queue-disc"
```

## 32.11 PIE queue disc

This chapter describes the PIE ([Pan13], [Pan16]) queue disc implementation in *ns-3*.

Proportional Integral controller Enhanced (PIE) is a queuing discipline that aims to solve the bufferbloat [Buf14] problem. The model in *ns-3* is a port of Preethi Natarajan's *ns-2* PIE model.

### 32.11.1 Model Description

The source code for the PIE model is located in the directory `src/traffic-control/model` and consists of 2 files `pie-queue-disc.h` and `pie-queue-disc.cc` defining a `PieQueueDisc` class. The code was ported to *ns-3* by Mohit P. Tahiliani, Shravya K. S. and Smriti Murali based on *ns-2* code implemented by Preethi Natarajan, Rong Pan, Chiara Piglionne, Greg White and Takashi Hayakawa. The implementation was aligned with RFC 8033 by Vivek Jain and Mohit P. Tahiliani for the *ns-3.32* release, with additional unit test cases contributed by Bhaskar Kataria.

- `class PieQueueDisc`: This class implements the main PIE algorithm:
  - `PieQueueDisc::DoEnqueue ()`: This routine checks whether the queue is full, and if so, drops the packets and records the number of drops due to queue overflow. If queue is not full then if `ActiveThreshold` is set then it checks if queue delay is higher than `ActiveThreshold` and if it is then, this routine calls `PieQueueDisc::DropEarly()`, and depending on the value returned, the incoming packet is either enqueued or dropped.
  - `PieQueueDisc::DropEarly ()`: The decision to enqueue or drop the packet is taken by invoking this routine, which returns a boolean value; false indicates enqueue and true indicates drop.
  - `PieQueueDisc::CalculateP ()`: This routine is called at a regular interval of `m_tUpdate` and updates the drop probability, which is required by `PieQueueDisc::DropEarly()`
  - `PieQueueDisc::DoDequeue ()`: This routine calculates queue delay using timestamps (by default) or, optionally with the `UseDequeRateEstimator` attribute enabled, calculates the average departure rate to estimate queue delay. A queue delay estimate required for updating the drop probability in `PieQueueDisc::CalculateP ()`. Starting with the *ns-3.32* release, the default approach to calculate queue delay has been changed to use timestamps.

## References

### Attributes

The key attributes that the `PieQueue` class holds include the following:

- `MaxSize`: The maximum number of bytes or packets the queue can hold.
- `MeanPktSize`: Mean packet size in bytes. The default value is 1000 bytes.

- `Tupdate`: Time period to calculate drop probability. The default value is 30 ms.
- `Supdate`: Start time of the update timer. The default value is 0 ms.
- `DequeueThreshold`: Minimum queue size in bytes before dequeue rate is measured. The default value is 10000 bytes.
- `QueueDelayReference`: Desired queue delay. The default value is 20 ms.
- `MaxBurstAllowance`: Current max burst allowance in seconds before random drop. The default value is 0.1 seconds.
- `A`: Value of alpha. The default value is 0.125.
- `B`: Value of beta. The default value is 1.25.
- `UseDequeueRateEstimator`: Enable/Disable usage of Dequeue Rate Estimator (Default: false).
- `UseEcn`: True to use ECN. Packets are marked instead of being dropped (Default: false).
- `MarkEcnThreshold`: ECN marking threshold (Default: 10% as suggested in RFC 8033).
- `UseDerandomization`: Enable/Disable Derandomization feature mentioned in RFC 8033 (Default: false).
- `UseCapDropAdjustment`: Enable/Disable Cap Drop Adjustment feature mentioned in RFC 8033 (Default: true).
- `ActiveThreshold`: Threshold for activating PIE (disabled by default).

## Examples

The example for PIE is *pie-example.cc* located in `src/traffic-control/examples`. To run the file (the first invocation below shows the available command-line options):

```
$ ./waf --run "pie-example --PrintHelp"  
$ ./waf --run "pie-example --writePcap=1"
```

The expected output from the previous commands are ten .pcap files.

### 32.11.2 Validation

The PIE model is tested using `PieQueueDiscTestSuite` class defined in *src/traffic-control/test/pie-queue-test-suite.cc*. The suite includes the following test cases:

- Test 1: simple enqueue/dequeue with defaults, no drops
- Test 2: more data with defaults, unforced drops but no forced drops
- Test 3: same as test 2, but with higher `QueueDelayReference`
- Test 4: same as test 2, but with reduced dequeue rate
- Test 5: same dequeue rate as test 4, but with higher `Tupdate`
- Test 6: same as test 2, but with `UseDequeueRateEstimator` enabled
- Test 7: test with `CapDropAdjustment` disabled
- Test 8: test with `CapDropAdjustment` enabled
- Test 9: PIE queue disc is ECN enabled, but packets are not ECN capable
- Test 10: Packets are ECN capable, but PIE queue disc is not ECN enabled

- Test 11: Packets and PIE queue disc both are ECN capable
- Test 12: test with Derandomization enabled
- Test 13: same as test 11 but with accumulated drop probability set below the low threshold
- Test 14: same as test 12 but with accumulated drop probability set above the high threshold
- Test 15: Tests Active/Inactive feature, ActiveThreshold set to a high value so PIE never starts.
- Test 16: Tests Active/Inactive feature, ActiveThreshold set to a low value so PIE starts early.

The test suite can be run using the following commands:

```
$ ./waf configure --enable-examples --enable-tests
$ ./waf build
$ ./test.py -s pie-queue-disc
```

or alternatively (to see logging statements in a debug build):

```
$ NS_LOG="PieQueueDisc" ./waf --run "test-runner --suite=pie-queue-disc"
```

## 32.12 Mq queue disc

This chapter describes the mq queue disc implementation in *ns-3*.

mq is a classful multiqueue dummy scheduler developed to best fit the multiqueue traffic control API in Linux. The mq scheduler presents device transmission queues as classes, allowing to attach different queue discs to them, which are grafted to the device transmission queues.

Mq is installed by default on multi-queue devices (such as Wifi) with as many FqCodel child queue discs as the number of device queues.

### 32.12.1 Model Description

mq is a multi-queue aware queue disc, meaning that it has as many child queue discs as the number of device transmission queues. Each child queue disc maps to a distinct device transmission queue. Every packet is enqueued into the child queue disc which maps to the device transmission queue in which the device will enqueue the packet.

In *ns-3*, `MqQueueDisc` has a wake mode of `WAKE_CHILD`, which means that the traffic control layer enqueues packets directly into one of the child queue discs (multi-queue devices can provide a callback to inform the traffic control layer of the device transmission queue that will be selected for a given packet). Therefore, `MqQueueDisc::DoEnqueue ()` shall never be called (in fact, it raises a fatal error). Given that dequeuing packets is triggered by enqueueing a packet in the queue disc or by the device invoking the wake callback, it turns out that `MqQueueDisc::DoDequeue ()` is never called as well (in fact, it raises a fatal error, too).

The mq queue disc does not require packet filters, does not admit internal queues and must have as many child queue discs as the number of device transmission queues.

### Examples

A typical usage pattern is to create a traffic control helper used to add the required number of queue disc classes, attach child queue discs to the classes and (if needed) add packet filters to the child queue discs. The following code shows how to install an mq queue disc having FqCodel child queue discs:

```
TrafficControlHelper tch;
uint16_t handle = tch.SetRootQueueDisc ("ns3::MqQueueDisc");
TrafficControlHelper::ClassIdList cls = tch.AddQueueDiscClasses (handle, numTxQueues,
↳"ns3::QueueDiscClass");
tch.AddChildQueueDiscs (handle, cls, "ns3::FqCoDelQueueDisc");
QueueDiscContainer qdiscs = tch.Install (devices);
```

Note that the child queue discs attached to the classes do not necessarily have to be of the same type.

### 32.12.2 Validation

The mq model is tested using `WifiAcMappingTestSuite` class defined in `src/test/wifi-ac-mapping-test-suite.cc`. The suite considers a node with a QoS-enabled wifi device (which has 4 transmission queues) and includes 4 test cases:

- Test 1: EF-marked packets are enqueued in the queue disc which maps to the AC\_VI queue
- Test 2: AF11-marked packets are enqueued in the queue disc which maps to the AC\_BK queue
- Test 3: AF32-marked packets are enqueued in the queue disc which maps to the AC\_BE queue
- Test 4: CS7-marked packets are enqueued in the queue disc which maps to the AC\_VO queue

The test suite can be run using the following commands:

```
$ ./waf configure --enable-examples --enable-tests
$ ./waf build
$ ./test.py -s ns3-wifi-ac-mapping
```

or

```
$ NS_LOG="WifiAcMappingTest" ./waf --run "test-runner --suite=ns3-wifi-ac-mapping"
```

## UAN FRAMEWORK

The main goal of the UAN Framework is to enable researchers to model a variety of underwater network scenarios. The UAN model is broken into four main parts: The channel, PHY, MAC and Autonomous Underwater Vehicle (AUV) models.

The need for underwater wireless communications exists in applications such as remote control in offshore oil industry<sup>1</sup>, pollution monitoring in environmental systems, speech transmission between divers, mapping of the ocean floor, mine counter measures<sup>2,4</sup>, seismic monitoring of ocean faults as well as climate changes monitoring. Unfortunately, making on-field measurements is very expensive and there are no commonly accepted standard to base on. Hence, the priority to make research work going on, it is to realize a complete simulation framework that researchers can use to experiment, make tests and make performance evaluation and comparison.

The NS-3 UAN module is a first step in this direction, trying to offer a reliable and realistic tool. In fact, the UAN module offers accurate modelling of the underwater acoustic channel, a model of the WHOI acoustic modem (one of the widely used acoustic modems)<sup>6</sup> and its communications performance, and some MAC protocols.

### 33.1 Model Description

The source code for the UAN Framework lives in the directory `src/uan` and in `src/energy` for the contribution on the li-ion battery model.

The UAN Framework is composed of two main parts:

- the AUV mobility models, including Electric motor propelled AUV (REMUS class<sup>3,4</sup>) and Seaglider<sup>5</sup> models
- the energy models, including AUV energy models, AUV energy sources (batteries) and an acoustic modem energy model

As enabling component for the energy models, a Li-Ion batteries energy source has been implemented basing on<sup>7,8</sup>.

---

<sup>1</sup> BINGHAM, D.; DRAKE, T.; HILL, A.; LOTT, R.; The Application of Autonomous Underwater Vehicle (AUV) Technology in the Oil Industry – Vision and Experiences, URL: [http://www.fig.net/pub/fig\\_2002/Ts4-4/TS4\\_4\\_bingham\\_etal.pdf](http://www.fig.net/pub/fig_2002/Ts4-4/TS4_4_bingham_etal.pdf)

<sup>2</sup> AUVfest2008: Underwater mines; URL: <http://oceanexplorer.noaa.gov/explorations/08auvfest/background/mines/mines.html>

<sup>3</sup> WHOI, Autonomous Underwater Vehicle, REMUS; URL: <http://www.whoi.edu/page.do?pid=29856>

<sup>4</sup> L. Freitag, M. Grund, I. Singh, J. Partan, P. Koski, K. Ball, and W. Hole, The whoi micro-modem: an acoustic communications and navigation system for multiple platforms, In Proc. IEEE OCEANS05 Conf, 2005. URL: <http://ieeexplore.ieee.org/iel5/10918/34367/01639901.pdf>

<sup>5</sup> Hydroinc Products; URL: <http://www.hydroinc.com/products.html>

<sup>6</sup> Eriksen, C.C., T.J. Osse, R.D. Light, T. Wen, T.W. Lehman, P.L. Sabin, J.W. Ballard, and A.M. Chiodi. Seaglider: A Long-Range Autonomous Underwater Vehicle for Oceanographic Research, IEEE Journal of Oceanic Engineering, 26, 4, October 2001. URL: <http://ieeexplore.ieee.org/stamp/stamp.jsp?tp=&arnumber=972073&userType=inst>

<sup>7</sup> C. M. Shepherd, “Design of Primary and Secondary Cells - Part 3. Battery discharge equation,” U.S. Naval Research Laboratory, 1963

<sup>8</sup> Tremblay, O.; Dessaint, L.-A.; Dekkiche, A.-I., “A Generic Battery Model for the Dynamic Simulation of Hybrid Electric Vehicles,” Ecole de Technologie Supérieure, Université du Québec, 2007 URL: <http://ieeexplore.ieee.org/stamp/stamp.jsp?tp=&arnumber=4544139>

### 33.1.1 Design

#### UAN Propagation Models

Modelling of the underwater acoustic channel has been an active area of research for quite some time. Given the complications involved, surface and bottom interactions, varying speed of sound, etc. . . , the detailed models in use for ocean acoustics research are much too complex (in terms of runtime) for use in network level simulations. We have attempted to provide the often used models as well as make an attempt to bridge, in part, the gap between complicated ocean acoustic models and network level simulation. The three propagation models included are the ideal channel model, the Thorp propagation model and the Bellhop propagation model (Available as an addition).

All of the Propagation Models follow the same simple interface in `ns3::UanPropModel`. The propagation models provide a power delay profile (PDP) and pathloss information. The PDP is retrieved using the `GetPdp` method which returns type `UanPdp`. `ns3::UanPdp` utilises a tapped delay line model for the acoustic channel. The `UanPdp` class is a container class for Taps, each tap has a delay and amplitude member corresponding to the time of arrival (relative to the first tap arrival time) and amplitude. The propagation model also provides pathloss between the source and receiver in dB re 1uPa. The PDP and pathloss can then be used to find the received signal power over a duration of time (i.e. received signal power in a symbol duration and ISI which interferes with neighbouring signals). Both `UanPropModelIdeal` and `UanPropModelThorp` return a single impulse for a PDP.

a) Ideal Channel Model `ns3::UanPropModelIdeal`

The ideal channel model assumes 0 pathloss inside a cylindrical area with bounds set by attribute. The ideal channel model also assumes an impulse PDP.

b) Thorp Propagation Model `ns3::UanPropModelThorp`

The Thorp Propagation Model calculates pathloss using the well-known Thorp approximation. This model is similar to the underwater channel model implemented in ns2 as described here:

Harris, A. F. and Zorzi, M. 2007. Modeling the underwater acoustic channel in ns2. In Proceedings of the 2nd international Conference on Performance Evaluation Methodologies and Tools (Nantes, France, October 22 - 27, 2007). ValueTools, vol. 321. ICST (Institute for Computer Sciences Social-Informatics and Telecommunications Engineering), ICST, Brussels, Belgium, 1-8.

The frequency used in calculation however, is the center frequency of the modulation as found from `ns3::UanTxMode`. The Thorp Propagation Model also assumes an impulse channel response.

c) Bellhop Propagation Model `ns3::UanPropModelBh` (Available as an addition)

The Bellhop propagation model reads propagation information from a database. A configuration file describing the location, and resolution of the archived information must be supplied via attributes. We have included a utility, `create-dat`, which can create these data files using the Bellhop Acoustic Ray Tracing software (<http://oalib.hlsresearch.com/>).

The `create-dat` utility requires a Bellhop installation to run. Bellhop takes environment information about the channel, such as sound speed profile, surface height bottom type, water depth, and uses a Gaussian ray tracing algorithm to determine propagation information. Arrivals from Bellhop are grouped together into equal length taps (the arrivals in a tap duration are coherently summed). The maximum taps are then aligned to take the same position in the PDP. The `create-dat` utility averages together several runs and then normalizes the average such that the sum of all taps is 1. The same configuration file used to create the data files using `create-dat` should be passed via attribute to the Bellhop Propagation Model.

The Bellhop propagation model is available as a patch. The link address will be made available here when it is posted online. Otherwise email [lentracy@gmail.com](mailto:lentracy@gmail.com) for more information.

#### UAN PHY Model Overview

The PHY has been designed to allow for relatively easy extension to new networking scenarios. We feel this is important as, to date, there has been no commonly accepted network level simulation model for underwater networks.

The lack of commonly accepted network simulation tools has resulted in a wide array of simulators and models used to report results in literature. The lack of standardization makes comparing results nearly impossible.

The main component of the PHY Model is the generic PHY class, `ns3::UanPhyGen`. The PHY class's general responsibility is to handle packet acquisition, error determination, and forwarding of successful packets up to the MAC layer. The Generic PHY uses two models for determination of signal to noise ratio (SINR) and packet error rate (PER). The combination of the PER and SINR models determine successful reception of packets. The PHY model connects to the channel via a Transducer class. The Transducer class is responsible for tracking all arriving packets and departing packets over the duration of the events. How the PHY class and the PER and SINR models respond to packets is based on the "Mode" of the transmission as described by the `ns3::UanTxMode` class.

When a MAC layer sends down a packet to the PHY for transmission it specifies a "mode number" to be used for the transmission. The PHY class accepts, as an attribute, a list of supported modes. The mode number corresponds to an index in the supported modes. The `UanTxMode` contains simple modulation information and a unique string id. The generic PHY class will only acquire arriving packets which use a mode which is in the supported modes list of the PHY. The mode along with received signal power, and other pertinent attributes (e.g. possibly interfering packets and their modes) are passed to the SINR and PER models for calculation of SINR and probability of error.

Several simple example PER and SINR models have been created. a) The PER models - Default (simple) PER model (`ns3::UanPhyPerGenDefault`): The Default PER model tests the packet against a threshold and assumes error (with prob. 1) if the SINR is below the threshold or success if the SINR is above the threshold - Micromodem FH-FSK PER (`ns3::UanPhyPerUmodem`). The FH-FSK PER model calculates probability of error assuming a rate 1/2 convolutional code with constraint length 9 and a CRC check capable of correcting up to 1 bit error. This is similar to what is used in the receiver of the WHOI Micromodem.

b) SINR models - Default Model (`ns3::UanPhyCalcSinrDefault`), The default SINR model assumes that all transmitted energy is captured at the receiver and that there is no ISI. Any received signal power from interferes acts as additional ambient noise. - FH-FSK SINR Model (`ns3::UanPhyCalcSinrFhFsk`), The WHOI Micromodem operating in FH-FSK mode uses a predetermined hopping pattern that is shared by all nodes in the network. We model this by only including signal energy receiving within one symbol time (as given by `ns3::UanTxMode`) in calculating the received signal power. A channel clearing time is given to the FH-FSK SINR model via attribute. Any signal energy arriving in adjacent signals (after a symbol time and the clearing time) is considered ISI and is treated as additional ambient noise. Interfering signal arrivals inside a symbol time (any symbol time) is also counted as additional ambient noise - Frequency filtered SINR (`ns3::UanPhyCalcSinrDual`). This SINR model calculates SINR in the same manner as the default model. This model however only considers interference if there is an overlap in frequency of the arriving packets as determined by `UanTxMode`.

In addition to the generic PHY a dual phy layer is also included (`ns3::UanPhyDual`). This wraps two generic phy layers together to model a net device which includes two receivers. This was primarily developed for `UanMacRc`, described in the next section.

## UAN MAC Model Overview

Over the last several years there have been a myriad of underwater MAC proposals in the literature. We have included three MAC protocols with this distribution: a) CW-MAC, a MAC protocol which uses a slotted contention window similar in nature to the IEEE 802.11 DCF. Nodes have a constant contention window measured in slot times (configured via attribute). If the channel is sensed busy, then nodes backoff by randomly (uniform distribution) choose a slot to transmit in. The slot time durations are also configured via attribute. This MAC was described in

Parrish N.; Tracy L.; Roy S. Arabshahi P.; and Fox, W., System Design Considerations for Undersea Networks: Link and Multiple Access Protocols , IEEE Journal on Selected Areas in Communications (JSAC), Special Issue on Underwater Wireless Communications and Networks, Dec. 2008.

b) RC-MAC (`ns3::UanMacRc ns3::UanMacRcGw`) a reservation channel protocol which dynamically divides the available bandwidth into a data channel and a control channel. This MAC protocol assumes there is a gateway node which all network traffic is destined for. The current implementation assumes a single gateway and a single network neighborhood (a single hop network). RTS/CTS handshaking is used and time is divided into cycles. Non-gateway

nodes transmit RTS packets on the control channel in parallel to data packet transmissions which were scheduled in the previous cycle at the start of a new cycle, the gateway responds on the data channel with a CTS packet which includes packet transmission times of data packets for received RTS packets in the previous cycle as well as bandwidth allocation information. At the end of a cycle ACK packets are transmitted for received data packets.

When a publication is available it will be cited here.

- c) Simple ALOHA (`ns3::UanMacAloha`) Nodes transmit at will.

## AUV mobility models

The AUV mobility models have been designed as in the follows.

### Use cases

The user will be able to:

- program the AUV to navigate over a path of waypoints
- control the velocity of the AUV
- control the depth of the AUV
- control the direction of the AUV
- control the pitch of the AUV
- tell the AUV to emerge or submerge to a specified depth

### AUV mobility models design

Implement a model of the navigation of AUV. This involves implementing two classes modelling the two major categories of AUVs: electric motor propelled (like REMUS class<sup>34</sup>) and “sea gliders”<sup>5</sup>. The classic AUVs are submarine-like devices, propelled by an electric motor linked with a propeller. Instead, the “sea glider” class exploits small changes in its buoyancy that, in conjunction with wings, can convert vertical motion to horizontal. So, a glider will reach a point into the water by describing a “saw-tooth” movement. Modelling the AUV navigation, involves in considering a real-world AUV class thus, taking into account maximum speed, directional capabilities, emerging and submerging times. Regarding the sea gliders, it is modelled the characteristic saw-tooth movement, with AUV’s speed driven by buoyancy and glide angle.

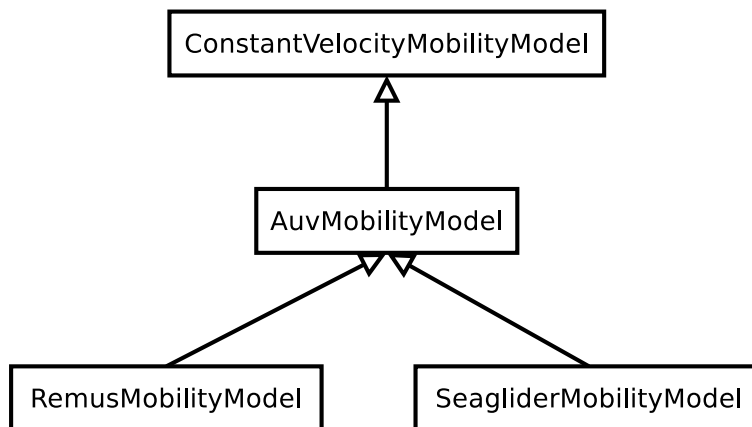

Fig. 1: AUV’s mobility model classes overview



An `ns3::AuvMobilityModel` interface has been designed to give users a generic interface to access AUV's navigation functions. The `AuvMobilityModel` interface is implemented by the `RemusMobilityModel` and the `GliderMobilityModel` classes. The AUV's mobility models organization it is shown in [AUV's mobility model classes overview](#). Both models use a constant velocity movement, thus the `AuvMobilityModel` interface derives from the `ConstantVelocityMobilityModel`. The two classes hold the navigation parameters for the two different AUVs, like maximum pitch angles, maximum operating depth, maximum and minimum speed values. The `Glider` model holds also some extra parameters like maximum buoyancy values, and maximum and minimum glide slopes. Both classes, `RemusMobilityModel` and `GliderMobilityModel`, handle also the AUV power consumption, utilizing the relative power models. Has been modified the `WaypointMobilityModel` to let it use a generic underlying `ConstantVelocityModel` to validate the waypoints and, to keep trace of the node's position. The default model is the classic `ConstantVelocityModel` but, for example in case of REMUS mobility model, the user can install the AUV mobility model into the waypoint model and then validating the waypoints against REMUS navigation constraints.

## Energy models

The energy models have been designed as in the follows.

### Use cases

The user will be able to:

- use a specific power profile for the acoustic modem
- use a specific energy model for the AUV
- trace the power consumption of AUV navigation, through AUV's energy model
- trace the power consumption underwater acoustic communications, through acoustic modem power profile

We have integrated the Energy Model with the UAN module, to implement energy handling. We have implemented a specific energy model for the two AUV classes and, an energy source for Lithium batteries. This will be really useful for researchers to keep trace of the AUV operational life. We have implemented also an acoustic modem power profile, to keep trace of its power consumption. This can be used to compare protocols specific power performance. In order to use such power profile, the acoustic transducer physical layer has been modified to use the modem power profile. We have decoupled the physical layer from the transducer specific energy model, to let the users change the different energy models without changing the physical layer.

### AUV energy models

Basing on the Device Energy Model interface, it has been implemented a specific energy model for the two AUV classes (REMUS and Seaglider). This models reproduce the AUV's specific power consumption to give users accurate information. This model can be naturally used to evaluates the AUV operating life, as well as mission-related power consumption, etc. Have been developed two AUV energy models:

- `GliderEnergyModel`, computes the power consumption of the vehicle based on the current buoyancy value and vertical speed<sup>5</sup>
- `RemusEnergyModel`, computes the power consumption of the vehicle based on the current speed, as it is propelled by a brush-less electric motor

---

**Note:** TODO extend a little bit

---

## AUV energy sources

---

**Note:** [TODO]

---

### Acoustic modem energy model

Basing on the Device Energy Model interface, has been implemented a generic energy model for acoustic modem. The model allows to trace four modem's power-states: Sleep, Idle, Receiving, Transmitting. The default parameters for the energy model are set to fit those of the WHOI  $\mu$ -modem. The class follows pretty closely the RadioEnergyModel class as the transducer behaviour is pretty close to that of a Wi-Fi radio.

The default power consumption values implemented into the model are as follows<sup>6</sup>:

Modem State	Power Consumption
TX	50 W
RX	158 mW
Idle	158 mW
Sleep	5.8 mW

### UAN module energy modifications

The UAN module has been modified in order to utilize the implemented energy classes. Specifically, it has been modified the physical layer of the UAN module. It Has been implemented an UpdatePowerConsumption method that takes the modem's state as parameter. It checks if an energy source is installed into the node and, in case, it then use the AcousticModemEnergyModel to update the power consumption with the current modem's state. The modem power consumption's update takes place whenever the modem changes its state.

A user should take into account that, if the power consumption handling is enabled (if the node has an energy source installed), all the communications processes will terminate whether the node depletes all the energy source.

### Li-Ion batteries model

A generic Li-Ion battery model has been implemented based on<sup>78</sup>. The model can be fitted to any type of Li-Ion battery simply changing the model's parameters The default values are fitted for the Panasonic CGR18650DA Li-Ion Battery<sup>9</sup>. [TODO insert figure] As shown in figure the model approximates very well the Li-Ion cells. Regarding Seagliders, the batteries used into the AUV are Electrochem 3B36 Lithium / Sulfuryl Chloride cells<sup>10</sup>. Also with this cell type, the model seems to approximates the different discharge curves pretty well, as shown in the figure.

---

**Note:** should I insert the li-ion model deatils here? I think it is better to put them into an Energy-related chapter..

---

## 33.1.2 Scope and Limitations

The framework is designed to simulate AUV's behaviour. We have modeled the navigation and power consumption behaviour of REMUS class and Seaglider AUVs. The communications stack, associated with the AUV, can be modi-

---

<sup>9</sup> Panasonic CGR18650DA Datasheet, URL: [http://www.panasonic.com/industrial/includes/pdf/Panasonic\\_LiIon\\_CGR18650DA.pdf](http://www.panasonic.com/industrial/includes/pdf/Panasonic_LiIon_CGR18650DA.pdf)

<sup>10</sup> Electrochem 3B36 Datasheet, URL: <http://www.electrochem.com.cn/products/Primary/HighRate/CSC/3B36.pdf>

fied depending on simulation needs. Usually, the default underwater stack is being used, composed of an half duplex acoustic modem, an Aloha MAC protocol and a generic physical layer.

Regarding the AUV energy consumption, the user should be aware that the level of accuracy differs for the two classes:

- Seaglider, high level of accuracy, thanks to the availability of detailed information on AUV's components and behaviour<sup>510</sup>. Have been modeled both the navigation power consumption and the Li battery packs (according to<sup>5</sup>).
- REMUS, medium level of accuracy, due to the lack of publicly available information on AUV's components. We have approximated the power consumption of the AUV's motor with a linear behaviour and, the energy source uses an ideal model (BasicEnergySource) with a power capacity equal to that specified in<sup>4</sup>.

### 33.1.3 Future Work

Some ideas could be :

- insert a data logging capability
- modify the framework to use sockets (enabling the possibility to use applications)
- introduce some more MAC protocols
- modify the physical layer to let it consider the Doppler spread (problematic in underwater environments)
- introduce OFDM modulations

### 33.1.4 References

## 33.2 Usage

The main way that users who write simulation scripts will typically interact with the UAN Framework is through the helper API and through the publicly visible attributes of the model.

The helper API is defined in `src/uan/helper/acoustic-modem-energy-model-helper.{cc,h}` and in `src/uan/helper/...{cc,h}`.

The example folder `src/uan/examples/` contain some basic code that shows how to set up and use the models. further examples can be found into the Unit tests in `src/uan/test/...cc`

### 33.2.1 Examples

Examples of the Framework's usage can be found into the examples folder. There are mobility related examples and UAN related ones.

#### Mobility Model Examples

- **auv-energy-model:** In this example we show the basic usage of an AUV energy model. Specifically, we show how to create a generic node, adding to it a basic energy source and consuming energy from the energy source. In this example we show the basic usage of an AUV energy model.

The Seaglider AUV power consumption depends on buoyancy and vertical speed values, so we simulate a 20 seconds movement at 0.3 m/s of vertical speed and 138g of buoyancy. Then a 20 seconds movement at 0.2 m/s of vertical speed and 138g of buoyancy and then a stop of 5 seconds.

The required energy will be drained by the model basing on the given buoyancy/speed values, from the energy source installed onto the node. We finally register a callback to the TotalEnergyConsumption traced value.

- **auv-mobility:** In this example we show how to use the AuvMobilityHelper to install an AUV mobility model into a (set of) node. Then we make the AUV to submerge to a depth of 1000 meters. We then set a callback function called on reaching of the target depth. The callback then makes the AUV to emerge to water surface (0 meters). We set also a callback function called on reaching of the target depth. The emerge callback then, stops the AUV.

During the whole navigation process, the AUV's position is tracked by the TracePos function and plotted into a Gnuplot graph.

- **waypoint-mobility:** We show how to use the WaypointMobilityModel with a non-standard ConstantVelocityMobilityModel. We first create a waypoint model with an underlying RemusMobilityModel setting the mobility trace with two waypoints. We then create a waypoint model with an underlying GliderMobilityModel setting the waypoints separately with the AddWaypoint method. The AUV's position is printed out every seconds.

## UAN Examples

- **li-ion-energy-source** In this simple example, we show how to create and drain energy from a LiIonEnergySource. We make a series of discharge calls to the energy source class, with different current drain and durations, until all the energy is depleted from the cell (i.e. the voltage of the cell goes below the threshold level). Every 20 seconds we print out the actual cell voltage to verify that it follows the discharge curve<sup>9</sup>. At the end of the example it is verified that after the energy depletion call, the cell voltage is below the threshold voltage.
- **uan-energy-auv** This is a comprehensive example where all the project's components are used. We setup two nodes, one fixed surface gateway equipped with an acoustic modem and a moving Seaglider AUV with an acoustic modem too. Using the waypoint mobility model with an underlying GliderMobilityModel, we make the glider descend to -1000 meters and then emerge to the water surface. The AUV sends a generic 17-bytes packet every 10 seconds during the navigation process. The gateway receives the packets and stores the total bytes amount. At the end of the simulation are shown the energy consumptions of the two nodes and the networking stats.

## 33.2.2 Helpers

In this section we give an overview of the available helpers and their behaviour.

### AcousticModemEnergyModelHelper

This helper installs AcousticModemEnergyModel into UanNetDevice objects only. It requires an UanNetDevice and an EnergySource as input objects.

The helper creates an AcousticModemEnergyModel with default parameters and associate it with the given energy source. It configures an EnergyModelCallback and an EnergyDepletionCallback. The depletion callback can be configured as a parameter.

### AuvGliderHelper

Installs into a node (or set of nodes) the Seaglider's features:

- waypoint model with underlying glider mobility model

- glider energy model
- glider energy source
- micro modem energy model

The glider mobility model is the `GliderMobilityModel` with default parameters. The glider energy model is the `GliderEnergyModel` with default parameters.

Regarding the energy source, the Seaglider features two battery packs, one for motor power and one for digital-analog power. Each pack is composed of 12 (10V) and 42 (24V) lithium chloride DD-cell batteries, respectively<sup>5</sup>. The total power capacity is around 17.5 MJ (3.9 MJ + 13.6 MJ). In the original version of the Seaglider there was 18 + 63 D-cell with a total power capacity of 10MJ.

The packs design is as follows:

- 10V - 3 in-series string x 4 strings = 12 cells - typical capacity ~100 Ah
- 24V - 7 in-series-strings x 6 strings = 42 cells - typical capacity ~150 Ah

Battery cells are Electrochem 3B36, with 3.6 V nominal voltage and 30.0 Ah nominal capacity. The 10V battery pack is associated with the electronic devices, while the 24V one is associated with the pump motor.

The micro modem energy model is the `MicroModemEnergyModel` with default parameters.

### AuvRemusHelper

Install into a node (or set of nodes) the REMUS features:

- waypoint model with REMUS mobility model validation
- REMUS energy model
- REMUS energy source
- micro modem energy model

The REMUS mobility model is the `RemusMobilityModel` with default parameters. The REMUS energy model is the `RemusEnergyModel` with default parameters.

Regarding the energy source, the REMUS features a rechargeable lithium ion battery pack rated 1.1 kWh @ 27 V (40 Ah) in operating conditions (specifications from<sup>3</sup> and Hydroinc European salesman). Since more detailed information about battery pack were not publicly available, the energy source used is a `BasicEnergySource`.

The micro modem energy model is the `MicroModemEnergyModel` with default parameters.

### 33.2.3 Attributes

---

**Note:** TODO

---

### 33.2.4 Tracing

---

**Note:** TODO

---

### 33.2.5 Logging

---

**Note:** TODO

---

### 33.2.6 Caveats

---

**Note:** TODO

---

## 33.3 Validation

This model has been tested with three UNIT test:

- auv-energy-model
- auv-mobility
- li-ion-energy-source

### 33.3.1 Auv Energy Model

Includes test cases for single packet energy consumption, energy depletion, Glider and REMUS energy consumption. The unit test can be found in `src/uan/test/auv-energy-model-test.cc`.

The single packet energy consumption test do the following:

- creates a two node network, one surface gateway and one fixed node at -500 m of depth
- install the acoustic communication stack with energy consumption support into the nodes
- a packet is sent from the underwater node to the gateway
- it is verified that both, the gateway and the fixed node, have consumed the expected amount of energy from their sources

The energy depletion test do the following steps:

- create a node with an empty energy source
- try to send a packet
- verify that the energy depletion callback has been invoked

The Glider energy consumption test do the following:

- create a node with glider capabilities
- make the vehicle to move to a predetermined waypoint
- verify that the energy consumed for the navigation is correct, according to the glider specifications

The REMUS energy consumption test do the following:

- create a node with REMUS capabilities
- make the vehicle to move to a predetermined waypoint

- verify that the energy consumed for the navigation is correct, according to the REMUS specifications

### 33.3.2 Auv Mobility

Includes test cases for glider and REMUS mobility models. The unit test can be found in `src/uan/test/auv-mobility-test.cc`.

- create a node with glider capabilities
- set a specified velocity vector and verify if the resulting buoyancy is the one that is supposed to be
- make the vehicle to submerge to a specified depth and verify if, at the end of the process the position is the one that is supposed to be
- make the vehicle to emerge to a specified depth and verify if, at the end of the process the position is the one that is supposed to be
- make the vehicle to navigate to a specified point, using direction, pitch and speed settings and, verify if at the end of the process the position is the one that is supposed to be
- make the vehicle to navigate to a specified point, using a velocity vector and, verify if at the end of the process the position is the one that is supposed to be

The REMUS mobility model test do the following: \* create a node with glider capabilities \* make the vehicle to submerge to a specified depth and verify if, at the end of the process the position is the one that is supposed to be \* make the vehicle to emerge to a specified depth and verify if, at the end of the process the position is the one that is supposed to be \* make the vehicle to navigate to a specified point, using direction, pitch and speed settings and, verify if at the end of the process the position is the one that is supposed to be \* make the vehicle to navigate to a specified point, using a velocity vector and, verify if at the end of the process the position is the one that is supposed to be

### 33.3.3 Li-Ion Energy Source

Includes test case for Li-Ion energy source. The unit test can be found in `src/energy/test/li-ion-energy-source-test.cc`.

The test case verify that after a well-known discharge time with constant current drain, the cell voltage has followed the datasheet discharge curve<sup>9</sup>.





## WAVE MODELS

WAVE is a system architecture for wireless-based vehicular communications, specified by the IEEE. This chapter documents available models for WAVE within *ns-3*. The focus is on the MAC layer and MAC extension layer defined by [ieee80211p] and [ieee1609dot4].

### 34.1 Model Description

WAVE is an overall system architecture for vehicular communications. The standards for specifying WAVE include a set of extensions to the IEEE 802.11 standard, found in IEEE Std 802.11p-2010 [ieee80211p], and the IEEE 1609 standard set, consisting of four documents: resource manager: IEEE 1609.1 [ieee1609dot1], security services: IEEE 1609.2 [ieee1609dot2], network and transport layer services: IEEE 1609.3 [ieee1609dot3], and multi-channel coordination: IEEE 1609.4 [ieee1609dot4]. Additionally, SAE standard J2735 [saej2735] describes a Dedicated Short Range Communications (DSRC) application message set that allows applications to transmit information using WAVE.

In *ns-3*, the focus of the `wave` module is on both the MAC layer and the multi-channel coordination layer. The key design aspect of 802.11p-compliant MAC layer is that they allow communications outside the context of a basic service set (BSS). The literature uses the acronym OCB to denote “outside the context of a BSS”, and the class `ns3::OcbWifiMac` models this in *ns-3*. This MAC does not require any association between devices (similar to an adhoc WiFi MAC). Many management frames will not be used, but when used, the BSSID field needs to be set to a wildcard BSSID value. Management information is transmitted by what is called a vendor specific action (VSA) frame. With these changes, the packet transmissions (for a moving vehicle) can be fast with small delay in the MAC layer. Users can create IEEE802.11p-compliant device (the object of the class `ns3::WifiNetDevice` associating with `ns3::OcbWifiMac`).

The key design aspect of the WAVE-compliant MAC layer (including 802.11p MAC layer and 1609.4 MAC extension layer) is that, based on OCB features, they provide devices with the capability of switching between control and service channels, using a single radio or using multiple radios. Therefore devices can communicate with others in single or multiple channels, which can support both safety related and non-safety related service for vehicular environments.

At the physical layer, the biggest difference is the use of the 5.9 GHz band with a channel bandwidth of 10 MHz. These physical layer changes can make the wireless signal relatively more stable, without degrading throughput too much (ranging from 3 Mbps to 27 Mbps).

The source code for the WAVE MAC models lives in the directory `src/wave`.

For better modeling WAVE and VANET, the WAVE models for high layers (mainly [ieee1609dot3]) are planned for a later patch.

#### 34.1.1 Design

In *ns-3*, support for 802.11p involves the MAC and PHY layers. To use an 802.11p NetDevice, `ns3::Wifi80211pHelper` is suggested.

In *ns-3*, support for WAVE involves the MAC, its MAC extension and PHY layers. To use a WAVE NetDevice, `ns3::WaveHelper` is suggested.

### MAC layer

The classes used to model the MAC layer are `ns3::OrganizationIdentifier`, `ns3::VendorSpecificActionHeader` and `ns3::OcbWifiMac`.

The `OrganizationIdentifier` and `VendorSpecificActionHeader` are used to support the sending of a Vendor Specific Action frame.

`OcbWifiMac` is very similar to `AdhocWifiMac`, with some modifications. The *ns-3* `AdhocWifiMac` class is implemented very close to the 802.11p OCB mode rather than a real 802.11 ad-hoc mode. The `AdhocWifiMac` has no BSS context that is defined in 802.11 standard, so it will not take time to send beacons and to authenticate, making its behavior similar to that of an `OcbWifiMac`.

1. `SetBssid`, `GetBssid`, `SetSsid`, `GetSsid`

These methods are related to 802.11 BSS context, and are unused in the OCB context.

2. `SetLinkUpCallback`, `SetLinkDownCallback`

WAVE device can send packets directly, so the WiFi link is never down.

3. `SendVsc`, `AddReceiveVscCallback`

WAVE management information shall be sent by vendor specific action frames, sent by the upper layer 1609.4 standard as WSA (WAVE Service Advertisement) packets or other vendor specific information.

4. `SendTimingAdvertisement` (not implemented)

Although Timing Advertisement is very important and specifically defined in 802.11p standard, it is not useful in a simulation environment. Every node in *ns-3* vehicular simulation is assumed to be already time synchronized (perhaps by GPS).

5. `ConfigureEdca`

This method will allow the user to set EDCA parameters of WAVE channels including CCH and SCHs. And the `OcbWifiMac` itself also uses this method to configure default 802.11p EDCA parameters.

6. Wildcard BSSID

The Wildcard BSSID is set to “ff:ff:ff:ff:ff:ff”. As defined in IEEE 802.11-2007, a wildcard BSSID shall not be used in the BSSID field except for management frames of subtype probe request. But Adhoc mode of *ns-3* simplifies this mechanism: when stations receive packets, they will be forwarded up to the higher layer, regardless of BSSID. This process is very close to OCB mode as defined in 802.11p-2010, in which stations use the wildcard BSSID to allow the higher layer of other stations to hear directly.

7. `Enqueue`, `Receive`

The most important methods are send and receive methods. According to the standard, we should filter the frames that are not permitted. Thus here we just identify the frames we care about; the other frames will be discarded.

### MAC extension layer

Although 1609.4 is still in the MAC layer, the implementation approach for *ns-3* does not do much modification in the source code of the wifi module. Instead, if some feature is related to wifi MAC classes, then a relevant subclass is defined; if some feature has no relation to wifi MAC classes, then a new class will be defined. This approach was selected to be non-intrusive to the *ns-3* wifi module. All of these classes will be hosted in a ‘container’ class

called `ns3::WaveNetDevice`. This class is a subclass inheriting from `ns3::NetDeivce`, composed of the objects of `ns3::ChannelScheduler`, `ns3::ChannelManager`, `ns3::ChannelCoordinator` and `ns3::VsaManager` classes to provide the features described in 1609.4 while still containing the objects of `ns3::OcbWifiMac` and `ns3::WifiPhy` classes. Moreover, `ns3::OcbWifiMac` class is further extended with support for IEEE 1609.4 associating with `ns3::HigherLayerTxVectorTag` and `ns3::WaveMacLow`. The main work of the `WaveNetDevice` is to create objects, configure, check arguments and provide new APIs for multiple channel operation as follows:

#### 1. AddMac, GetMac and GetMacs

Different from `ns3::WifiNetDevice`, the WAVE device will have multiple internal MAC entities rather than a single one. Each MAC entity is used to support each WAVE channel. Thus, when devices switch from the current channel to the next channel in different channel intervals, the packets in the internal queue will not be flushed and the current MAC entity will perform a suspend operation until woken up in next appropriate channel interval.

#### 2. AddPhy, GetPhy and GetPhys

Also in contrast to `ns3::WifiNetDevice`, the WAVE device here can allow more than one PHY entity, which permits the use cases of of single-PHY devices or multiple-PHY devices.

#### 3. SetChannelScheduler and GetChannelScheduler

How to deal with multiple MAC entities and PHY entities to assign channel access for different requests from higher layer? IEEE 1609.4 [ieee1609dot4] does not seem to give a very clear and detailed mechanism, deferring to the implementor. In this model, the class `ns3::ChannelScheduler` provides the API and delegates to the subclasses to implement the virtual methods. In the current implementation, the default assignment mechanism for channel access, called `ns3::DefaultChannelScheduler`, gives a simple answer that only deals with multiple channel operation in the context of a single-PHY device. If users define their own different assignment mechanisms such as in the context of two PHY entities, they can easily reuse models using `AddPhy` and `SetChannelScheduler` methods to import a new assignment mechanism.

#### 4. SetChannelManager and GetChannelManager

class `ns3::ChannelManager` is a WAVE channel set which contains valid WAVE channel numbers. Moreover, the tx information in this channel set such as data rate and tx power level is used for transmitting management frames.

#### 5. SetVsaManager and GetVsaManager

class `ns3::VsaManager` is used to deal with sending and receiving VSA frames. According to different request parameters from the higher layer, this class may transmit VSA frames repeatedly in the appropriate channel number and channel interval.

#### 6. SetChannelCoordinator and GetChannelCoordinator

class `ns3::ChannelCoordinator` is used to deal with channel coordination. The WAVE device can be aware of the channel interval at the current time or in the future. It can also notify listeners about incoming channel coordination events. Generally this class is used in the case of assigning alternating CCH and SCH access.

#### 7. StartSch and StopSch

In contrast to the basic 802.11p device that allow transmission packets immediately after the device is created, the WAVE device should assign channel access for sending packets. This method will call class `ns3::ChannelScheduler` to assign radio resources for the relevant channel.

#### 8. ChangeAddress

The WAVE device can support a change of address after devices are already initialized, which will cause all of MAC entities reset their status.

#### 9. CancelTx

The WAVE device can support a request to cancel all transmissions associated with the particular category and channel number, which will reset the particular interval queue and drop all of the queued packets in this queue.

#### 10. RegisterTxProfile and DeleteTxProfile

After channel access is assigned, we still cannot send IP-based (or other protocol) packets by the Send () method. A tx profile should be registered to specify tx parameters before transmission.

#### 11. StartVsa, StopVsa and SetWaveVsaCallback

These methods will call an object from class `ns3::VsaManager` to send and receive VSA frames. Generally these methods are used by IEEE 1609.3 for WSA management information.

#### 12. SendX

After channel access is assigned, we can send WSMP (or other protocol) packets via the SendX () method. We should specify the tx parameters for each packet, e.g. the channel number for transmit.

#### 13. Send and SetReceiveCallback

This method is the abstract method defined in the parent class `ns3::NetDevice`, defined to allow the sending of IP-based packets. The channel access should be already assigned and tx profile should be registered, otherwise incoming packets from the higher layer will be discarded. No matter whether packets are sent by Send method or SendX method, the received packets will be only be delivered to the higher layer by the registered ReceiveCallback.

#### 14. other methods from its parent class `ns3::NetDevice`

These methods are implemented very similar to the code in `ns3::WifiNetDevice`.

In the above numbered list, we can categorize the methods into three types: the first type, from 1 to 6 and also 14, is the configuration for modeling and creating a WAVE device; the second type, from 7 to 11, is the management plane of the standard; and the third type, 12 and 13, is the data plane of the standard.

### Channel coordination

The class `ns3::ChannelCoordinator` defines the CCH Interval, SCH Interval and GuardInterval. Users can be aware of which interval the current time or future time will be in. If channel access mode is assigned to alternating CCH and SCH access, channel interval events will be notified repeatedly for class `ns3::ChannelCoordinator` to switch channels. Current default values are for CCHI with 50ms interval, SCHI with 50ms interval, and GuardI with 4ms interval. Users can change these values by configuring the class attributes.

### Channel routing

Channel routing service means different transmission approaches for WSMP data, IP datagram and management information. For WSMP data, the SendX () method implements the service primitive MA-UNITDATAX, and users can set transmission parameters for each individual packet. The parameters include channel number, priority, data rate and tx power level (expiration time is not supported now). For IP datagrams, the Send () method is a virtual method from `ns3::NetDevice` that implements the service primitive MA-UNITDATA. Users should insert QoS tags into packets themselves if they want to use QoS. Moreover, a tx profile should be registered before the Send method is called for transmit; the profile contains SCH number, data rate, power level and adaptable mode. For management information, StartVsa method implements the service primitive MLMEX-VSA. The tx information is already configured in `ns3::ChannelManager`, including data rate, power level and adaptable mode.

### Channel access assignment

The channel access assignment is done by class `ns3::ChannelScheduler` to assign ContinuousAccess, ExtendedAccess and AlternatingAccess. Besides that, immediate access is achieved by enabling the “immediate” parameter, in which case the request channel will be switched to immediately. However this class is a virtual parent class. The current module provides a subclass `ns3::DefaultChannelScheduler` to assign channel access in the

context of a single-PHY device. In this subclass, if the channel access is already assigned for another request, the next coming request will fail until the previous channel access is released. Users can implement different assignment mechanisms to deal with multiple MAC entities and multiple PHY entities by inheriting from parent class `ns3::ChannelScheduler`. An important point is that channel access should be assigned before sending routing packets, otherwise the packets will be discard.

#### Vendor Specific Action frames

When users want to send VSA repeatedly by calling `WaveNetDevice::StartVsa`, VSA will be sent repeatedly by `ns3::VsaManager`. It is worth noting that if the peer MAC address is a unicast address, the VSA can only be transmitted once even there is a repeat request. The tx parameters for VSA management frames can be obtained from the `ns3::ChannelManager`.

#### User priority and Multi-channel synchronization

Since wifi module has already implemented a QoS mechanism, the wave module reuses the mechanism; VSA frames will be assigned the default value with the highest AC according to the standard. Multiple-channel synchronization is very important in practice for devices without a local timing source. However, in simulation, every node is supposed to have the same system clock, which could be provided by GPS devices in a real environment, so this feature is not modelled in *ns-3*. During the guard interval, the device can only be in receive state, except for the switch state when the device does channel switching operation.

## PHY layer

No modification or extension is made to the *ns-3* PHY layer corresponding to this model. In the 802.11p standard, the PHY layer wireless technology is still 80211a OFDM with a 10MHz channel width, so `Wifi80211pHelper` will only allow the user to set the standard to `WIFI_PHY_STANDARD_80211_10MHZ` or `WIFI_PHY_STANDARD_80211_20MHZ`, while `WaveHelper` will only support `WIFI_PHY_STANDARD_80211_10MHZ`. The maximum station transmit power and maximum permitted EIRP defined in 802.11p is larger than that of WiFi, so transmit range can normally become longer than the usual WiFi. However, this feature will not be implemented. Users who want to obtain longer range should configure attributes “TxPowerStart”, “TxPowerEnd” and “TxPowerLevels” of the `YansWifiPhy` class by themselves.

### 34.1.2 Scope and Limitations

1. Does the model involve vehicular mobility of some sort?

Vehicular networks involve not only communication protocols, but also a communication environment including vehicular mobility and propagation loss models. Because of specific features of the latter, the protocols need to change. The MAC layer model in this project just adapts MAC changes to vehicular environment. However this model does not involve any vehicular mobility with time limit. While users should understand that vehicular mobility is out of scope for the current WAVE module, they can use any mobility model in *ns-3*. For example, users may use a `ns3::RandomWaypointMobilityModel` (RWP) for node mobility or may generate ns-2-style playback files using other third-party tools and then playback those mobility traces using `ns3::Ns2MobilityHelper`.

2. Does this model use different propagation models?

Referring to the first issue, some more realistic propagation loss models for vehicular environment are suggested and welcome. Some existing propagation loss models in *ns-3* are also suitable. Normally, users can use Friis, Two-Ray Ground, and Nakagami models. The `ns3::VanetRoutingExample` example defaults to Two-Ray Ground propagation loss with no additional fading, although adding stochastic Nakagami-m fading is parametrically supported.

3. Are there any vehicular application models to drive the code?

About vehicular application models, SAE J2375 depends on WAVE architecture and is an application message set in US. Cooperative Awareness Messages (CAM) and Decentralized Environment Notification Messages (DENM) can be sent Europe between network and application layer, and is very close to being an application model. The BSM in J2375



(continued from previous page)

```
wifiPhy.SetChannel (wifiChannel.Create ());
NqosWave80211pMacHelper wifi80211pMac = NqosWaveMacHelper::Default ();
Wifi80211pHelper 80211pHelper = Wifi80211pHelper::Default ();
devices = 80211pHelper.Install (wifiPhy, wifi80211pMac, nodes);
```

The relation of `ns3::YansWavePhyHelper`, `ns3::QosWaveMacHelper` and `ns3::WaveHelper` is described as below:

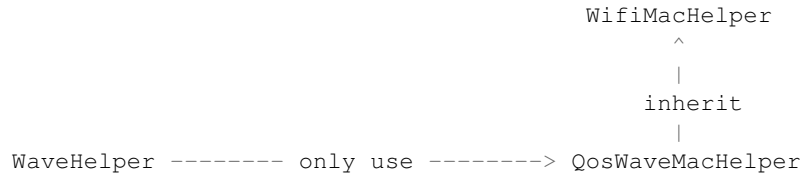

From the above diagram, `WaveHelper` is not the subclass of `WifiHelper` and should only use `QosWaveMacHelper` because WAVE MAC layer is based on QoS mechanism. But the `WaveHelper` is recommended if there is a need for multiple channel operation. Usage is as follows:

```
NodeContainer nodes;
NetDeviceContainer devices;
nodes.Create (2);
YansWifiChannelHelper wifiChannel = YansWifiChannelHelper::Default ();
YansWavePhyHelper wavePhy = YansWavePhyHelper::Default ();
wavePhy.SetChannel (wifiChannel.Create ());
QosWaveMacHelper waveMac = QosWaveMacHelper::Default ();
WaveHelper waveHelper = WaveHelper::Default ();
devices = waveHelper.Install (wavePhy, waveMac, nodes);
```

The higher-level helpers include `ns3::WaveBsmStats` and `ns3::WaveBsmHelper`.

`WaveBsmStats` is used to collect and manage statistics, such as packet and byte counts and Packet Delivery Ratio (PDR), regarding the sending and receiving of WAVE BSM packets. `WaveBsmHelper` is used by applications that wish to send and receive BSMs.

The relation of `ns3::WaveBsmHelper` and `WaveBsmStats` is described below:

```
<Your Vanet Routing Application> ----use----> WaveBsmHelper ----use----> WaveBsmStats
```

From <Your Vanet Routing Application>, usage is as follows:

```
// declare WAVE BSM helper instance WaveBsmHelper m_waveBsmHelper;

// the following are passed to the WaveBsmHelper::Install() // method, and they are thus assumed to be
// created and // initialized themselves, based on the user's // simulation setup criteria. // container of net-
// work node NodeContainer m_adhocTxNodes; // (transmitting) devices (1 per node) NetDeviceContainer
// m_adhocTxDevices; // IPv4 interfaces (1 per device) Ipv4InterfaceContainer m_adhocTxInterfaces; // total
// simulation time (in seconds) double m_TotalSimTime; // WAVE BSM broadcast interval. E.g., 100ms
// = 0.1 seconds double m_waveInterval; // seconds // time-synchronization accuracy of GPS devices. E.g.,
// +/- 40ns double m_gpsAccuracyNs; // array of distances (m) at which safety PDR shall be determined,
// e.g. 50m, 100m, 200m, 300m, 400m, 500m, 600m, 800m, 1000m, and 1500m std::vector <double>
// m_txSafetyRanges; // used to get consistent random numbers across scenarios int64_t m_streamIndex;

m_waveBsmHelper.Install (m_adhocTxNodes, m_adhocTxDevices, m_adhocTxInterfaces, Seconds(m_TotalSimTime), m_wavePacketSize, Seconds(m_waveInterval), // convert GPS accuracy,
// in ns, to Time Seconds(m_gpsAccuracyNs / 1000000.0), m_txSafetyRanges);

// fix random number streams m_streamIndex += m_waveBsmHelper.AssignStreams (m_streamIndex);
```

Example usages of BSM statistics are as follows:

```
// Get the cumulative PDR of the first safety Tx range (i.e, 50m in the // m_txSafetyRanges example
above). double bsm_pdr1 = m_waveBsmHelper.GetWaveBsmStats ()->GetBsmPdr (1);

// total WAVE BSM bytes sent uint32_t cumulativeWaveBsmBytes =
m_waveBsmHelper.GetWaveBsmStats ()->GetTxByteCount ();

// get number of WAVE BSM packets sent int wavePktsSent = m_waveBsmHelper.GetWaveBsmStats
()->GetTxPktCount ();

// get number of WAVE BSM packets received int wavePktsReceived =
m_waveBsmHelper.GetWaveBsmStats ()->GetRxPktCount ();

// reset count of WAVE BSM packets received m_waveBsmHelper.GetWaveBsmStats ()->SetRxPktCount
(0);

// reset count of WAVE BSM packets sent m_waveBsmHelper.GetWaveBsmStats ()->SetTxPktCount (0);

// indicate that a node (nodeId) is moving. (set to 0 to “stop” node) WaveB-
smHelper::GetNodesMoving()[nodeId] = 1;
```

## 34.2.2 APIs

### MAC layer

The 802.11p device can allow the upper layer to send different information over Vendor Specific Action management frames by using different OrganizationIdentifier fields to identify differences.

1. create some Node objects and WifiNetDevice objects, e.g. one sender and one receiver.
2. receiver defines an OrganizationIdentifier

```
uint8_t oi_bytes[5] = {0x00, 0x50, 0xC2, 0x4A, 0x40};
OrganizationIdentifier oi(oi_bytes,5);
```

3. receiver defines a Callback for the defined OrganizationIdentifier

```
VscCallback vsccall = MakeCallback (&VsaExample::GetWsaAndOi, this);
```

4. receiver registers this identifier and function

```
Ptr<WifiNetDevice> device1 = DynamicCast<WifiNetDevice>(nodes.Get (i)->
->GetDevice (0));
Ptr<OcbWifiMac> ocb1 = DynamicCast<OcbWifiMac>(device->GetMac ());
ocb1->AddReceiveVscCallback (oi, vsccall);
```

5. sender transmits management information over VSA frames

```
Ptr<Packet> vsc = Create<Packet> ();
ocb2->SendVsc (vsc, Mac48Address::GetBroadcast (), m_16093oi);
```

6. then registered callbacks in the receiver will be called.

### MAC extension layer

The WAVE devices allow the upper layer to route packets in different control approaches. However dedicated APIs and invocation sequences should be followed; otherwise, the packets may be discarded by devices.



1. create some Node objects and WaveNetDevice objects by helpers, e.g. one sender and one receiver.
2. receiver registers the receive callback if WSMP and IP-based packets are supposed to be received.

```
// the class ``ns3::WaveNetDeviceExample`` here will has a receive method
↳"Receive" to be registered.
receiver->SetReceiveCallback (MakeCallback (&WaveNetDeviceExample::Receive,
↳this));
```

3. receiver registers the receive callback if WSA frames are supposed to be received.

```
// the class ``ns3::WaveNetDeviceExample`` here will has a receive method
↳"ReceiveVsa" to be registered.
receiver->SetWaveVsaCallback (MakeCallback (&
↳WaveNetDeviceExample::ReceiveVsa, this));
```

4. sender and receiver assign channel access by StartSch method.

```
// in this case that alternating access with non-immediate mode is assigned
↳for sender and receiver devices.
const SchInfo schInfo = SchInfo (SCH1, false, EXTENDED_ALTERNATING);
Simulator::Schedule (Seconds (0.0), &WaveNetDevice::StartSch, sender,
↳schInfo);
Simulator::Schedule (Seconds (0.0), &WaveNetDevice::StartSch, receiver,
↳schInfo);
```

or

```
// in this case that continuous access with immediate mode is assigned for
↳sender and receiver devices.
const SchInfo schInfo = SchInfo (SCH1, true, EXTENDED_CONTINUOUS);
Simulator::Schedule (Seconds (0.0), &WaveNetDevice::StartSch, sender,
↳schInfo);
Simulator::Schedule (Seconds (0.0), &WaveNetDevice::StartSch, receiver,
↳schInfo)
```

or

```
// in this case that extended access with non-immediate mode is assigned for
↳sender and receiver devices.
const SchInfo schInfo = SchInfo (SCH1, false, 100);
Simulator::Schedule (Seconds (0.0), &WaveNetDevice::StartSch, sender,
↳schInfo);
Simulator::Schedule (Seconds (0.0), &WaveNetDevice::StartSch, receiver,
↳schInfo)
```

5. sender registers a tx profile if IP-based packets are planned to be transmitted

```
// the IP-based packets will be transmitted in SCH1 with 6Mbps and 4
↳txPowerLevel with adaptable mode.
const TxProfile txProfile = TxProfile (SCH1, true, 4, WifiMode(
↳"OfdmRate6MbpsBW10MHz"));
Simulator::Schedule (Seconds (2.0), &WaveNetDevice::RegisterTxProfile,
↳sender, txProfile);
```

6. sender transmits WSMP packets by SendX method.

```
// the data rate and txPowerLevel is controlled by the high layer which are
↳6Mbps and 0 level here.
const TxInfo txInfo = TxInfo (CCH, 7, WifiMode("OfdmRate6MbpsBW10MHz"), 0);
// this packet will contain WSMP header when IEEE 1609.3 model is implemented
const static uint16_t WSMP_PROT_NUMBER = 0x88DC;
Ptr<Packet> wsaPacket = Create<Packet> (100);
const Address dest = receiver->GetAddress ();
Simulator::Schedule (Seconds (2.0), &WaveNetDevice::SendX, sender,
↳wsaPacket, dest, WSMP_PROT_NUMBER, txInfo);
```

or

```
// the data rate and txPowerLevel is controlled by the MAC layer which are
↳decided by WifiRemoteStationManager
const TxInfo txInfo = TxInfo (CCH, 7, WifiMode(), 8);
// this packet will contain WSMP header when IEEE 1609.3 model is implemented
const static uint16_t WSMP_PROT_NUMBER = 0x88DC;
Ptr<Packet> wsaPacket = Create<Packet> (100);
const Address dest = receiver->GetAddress ();
Simulator::Schedule (Seconds (2.0), &WaveNetDevice::SendX, sender,
↳wsaPacket, dest, WSMP_PROT_NUMBER, txInfo);
```

#### 7. sender transmits IP-based packets by Send method.

```
const static uint16_t IPv6_PROT_NUMBER = 0x86DD;
Ptr<Packet> packet = Create<Packet> (100);
const Address dest = receiver->GetAddress ();
Simulator::Schedule (Seconds (2.0), &WaveNetDevice::Send, sender, packet,
↳dest, IPv6_PROT_NUMBER);
```

#### 8. send transmits WSA frames repeatedly by StartVsa method.

```
// this packet will contain WSA management information when IEEE 1609.3
↳model is implemented
Ptr<Packet> wsaPacket = Create<Packet> (100);
Mac48Address dest = Mac48Address::GetBroadcast ();
const VsaInfo vsaInfo = VsaInfo (dest, OrganizationIdentifier (), 0,
↳wsaPacket, SCH1, 100, VSA_TRANSMIT_IN_BOTHI);
Simulator::Schedule (Seconds (2.0), &WaveNetDevice::StartVsa, sender,
↳vsaInfo);
```

#### 9. sender stops WSA frames repeatedly transmit by StopVsa method.

```
Simulator::Schedule (Seconds (3.0), &WaveNetDevice::StopVsa, sender, SCH1);
```

#### 10. sender and receiver release assigned channel access by StopSch method.

```
Simulator::Schedule (Seconds (4.0), &WaveNetDevice::StopSch, sender, SCH1);
Simulator::Schedule (Seconds (4.0), &WaveNetDevice::StopSch, receiver, SCH1);
```

#### 11. sender or receiver changes current MAC address by ChangeAddress method.

```
Address newAddress = Mac48Address::Allocate ();
Simulator::Schedule (Seconds (4.0), &WaveNetDevice::ChangeAddress, sender,
↳newAddress);
```

#### 12. sender cancels all transmissions with the particular category and channel number by CancelTx method.

```

Simulator::Schedule (Seconds (4.0), &WaveNetDevice::CancelTx, sender, CCH,
↳AC_BE);

```

For transmitting and receiving these packets successfully, the normal and appropriate invocation procedures should be performed.

(a) For WSMP, channel access should be assigned for transmit and receive. The channel access release operation may be optional if there is no need for transmission in another channel.

```

StartSch -----> SendX / ReceiveCallback -----> StopSch

```

(b) For IP, a tx profile should be registered before transmit and receive operations. The delete operation of tx profile may be optional if there is no need for transmission with other tx parameters. The channel access assignment and release optional usage is the same with WSMP here.

```

StartSch -----> RegisterTxProfile -----> Send / ReceiveCallback -----
↳-----> DeleteTxProfile -----> StopSch

```

(c) For WSA, StartVsa is called to transmit while StopVsa is an optional operation for canceling repeat transmit. The channel access assignment and release optional usage is also the same with WSMP here. To receive VSA, WaveVsaCallback should be registered; otherwise, the received VSA frames will be discarded by the MAC extension layer and not delivered to the higher layer.

```

StartSch -----> StartVsa / WaveVsaCallback -----> StopVsa -----
↳-----> StopSch

```

(d) Here an important point is that if the higher layer wants to transmit these packets in a control channel (the channel 178), there will be no need to request for CCH by the StartSch method, which means that StartSch can be optional or should be avoided here. The reason is that the default continuous CCH access has been assigned automatically after WAVE devices are created and initialized. Therefore, if calling StartSch and StopSch method with CCH as a parameter, the request will be discarded by devices and the method will return false to indicate failure.

### 34.2.3 Attributes

The channel interval duration's default value is defined in the standard. However, the current implementation allows users to configure these attributes with other values. These attributes are included in the class `ns3::ChannelCoordinator` with config paths shown in the below. The method `IsValidConfig` is suggested to test whether new configuration follows the standard.

```

/NodeList/[i]/DeviceList/[i]/$ns3::WaveNetDevice/ChannelCoordinator/
↳$ns3::ChannelCoordinator/CchInterval
/NodeList/[i]/DeviceList/[i]/$ns3::WaveNetDevice/ChannelCoordinator/
↳$ns3::ChannelCoordinator/SchInterval
/NodeList/[i]/DeviceList/[i]/$ns3::WaveNetDevice/ChannelCoordinator/
↳$ns3::ChannelCoordinator/GuardInterval

```

The `ns3::WaveNetDevice` is a wrapper class that contains those classes to support for multiple channel operation. To set or get the pointers of those objects, users can also use them by config paths shown in the below.

```

/NodeList/[i]/DeviceList/[i]/$ns3::WaveNetDevice/Mtu
/NodeList/[i]/DeviceList/[i]/$ns3::WaveNetDevice/Channel
/NodeList/[i]/DeviceList/[i]/$ns3::WaveNetDevice/PhyEntities
/NodeList/[i]/DeviceList/[i]/$ns3::WaveNetDevice/MacEntities
/NodeList/[i]/DeviceList/[i]/$ns3::WaveNetDevice/ChannelScheduler
/NodeList/[i]/DeviceList/[i]/$ns3::WaveNetDevice/ChannelManager

```

(continues on next page)

(continued from previous page)

```
/NodeList/[i]/DeviceList/[i]/$ns3::WaveNetDevice/ChannelCoordinator
/NodeList/[i]/DeviceList/[i]/$ns3::WaveNetDevice/VsaManager
```

### 34.2.4 Output

For the 802.11p device, current classes provide output of the same type as WiFi devices; namely, ASCII and pcap traces, and logging output. The 802.11p logging components can be enabled globally via the call to

```
Wifi80211pHelper::EnableLogComponents ();
```

For the WAVE device, current classes provide output of the same type as WiFi devices; namely, ASCII and pcap traces, and logging output. The WAVE logging components can be enabled globally via the call to

```
WaveHelper::EnableLogComponents ();
```

### 34.2.5 Advanced Usage

#### Advanced WaveHelper configuration

If users can make sure in which channel this WAVE device will work, they can set specific channel numbers to save resources of unused channels . Usage is as follows:

```
// in this case, the MAC entities for SCH2 to SCH6 will not be created
WaveHelper helper = WaveHelper::Default ();
uint32_t channels[] = {CCH, SCH1};
std::vector<uint32_t> channelsVector (channels, channels + 2);
helper.CreateMacForChannel (channelsVector);
```

If users can create other channel access assignment mechanism, e.g. in the context of more PHY entities, which may be called “ns3::AnotherScheduler”, they can use this helper to create WAVE devices with new assignment mechanisms. Usage is as follows:

```
WaveHelper helper = WaveHelper::Default ();
helper.helper.CreateMacForChannel (ChannelManager::GetWaveChannels ()); // create
↳all 7 MAC entities for WAVE
helper.CreatePhys (2); // or other number which should be less than 7
helper.SetChannelScheduler ("ns3::AnotherScheduler"); // The AnotherScheduler
↳should be implemented by users.
helper.SetRemoteStationManager ("ns3::ConstantRateWifiManager"); // or other rate
↳control algorithms
```

### 34.2.6 Examples

A basic example exists called `wave-simple-80211p.cc`. This example shows basic construction of an 802.11p node. Two nodes are constructed with 802.11p devices, and by default, one node sends a single packet to another node (the number of packets and interval between them can be configured by command-line arguments). The example shows typical usage of the helper classes for this mode of WiFi.

Another example exists called `wave-simple-device.cc`. This example shows how to create WAVE devices by helpers and the routing service for different packets. After WAVE devices are configured and created by helpers, these packets are transmitted in different approaches.

Another example exists called `vanet-routing-compare.cc`. This example shows how to create mobility nodes in a VANET scenario and send Basic Safety Message (BSM) packets at regular intervals and/or additional data traffic to be routed between nodes. BSMs are transmitted assuming the WAVE Short Message Protocol (WSMP), whereas non-BSM data packets are relayed by using one of several different IP-based routing protocols (e.g., AODV, OLSR, DSDV, or DSR).

### 34.2.7 Troubleshooting

To be defined.

## 34.3 Validation

A test suite named `wifi-80211p-ocb` is defined. This test case consists of a stationary node and a mobile node. The mobile node moves towards the stationary mode, and time points are checked at which time the physical layer starts to receive packets (and whether the MAC becomes associated, if applicable). The same physical experiment is repeated for normal WiFi NetDevices in AP/STA mode, in Adhoc mode, and the new OCB mode.

Another test suite named `wave-mac-extension` is defined. This test suite has four test cases, including `channel-coordination`, `channel-routing`, `channel-access` and `annex-c`. The first case is to test channel coordination feature. The second case is to test channel routing for three types of packets. The third case is to test four channel access assignments. And the fourth case is to test the implemented feature described in the Annex C of the standard. It is worth noting that the `channel-routing` and `channel-access` test cases are both in the context of single-PHY device, which depends on the default channel access assignment mechanism `ns3:DefaultChannelScheduler`, thus they may not be suitable for testing when other channel access assignment mechanisms are used. Although they are test cases, they are also good examples to show usage.

The `ns3::VanetRoutingExample` example was studied using mobility trace files in the Raleigh, NC USA area generated using Simulation for Urban Mobility (SUMO). Three environments were studied: a) an open highway scenario, b) a residential neighborhood scenario, and c) an urban downtown scenario. For each environment, a constant number of 50-750 vehicles was maintained for 2000 simulation seconds (> 30 minutes). The mobility trace file were played back using `ns3::Ns2MobilityHelper`. All vehicular nodes transmitted a 200-byte BSM at 10 Hz and the PDR was determined for transmission ranges of 50-1500m. No additional non-BSM data was injected / routed through the network. The default propagation loss model used was Two-Ray Ground. Different fading / shadowing models were evaluated, including a) no fading, b) stochastic Nakagami-m fading, and c) an obstacle shadowing model (to be contributed to *ns-3*). 30 trials of each scenario were run in the North Carolina State University (NCSU) High Performance Computing (HPC) center, with each trial requiring from 8 hours to 6 days of CPU time to complete. Preliminary results were presented at the PhD Forum, 22nd IEEE International Conference on Network Protocols (ICNP), October 24, 2014, Research Triangle Park, NC. See: [http://www4.ncsu.edu/~scarpen/Research\\_files/Final-PHD\\_Forum\\_SE\\_Carpenter\\_2014.pdf](http://www4.ncsu.edu/~scarpen/Research_files/Final-PHD_Forum_SE_Carpenter_2014.pdf)



## WI-FI MODULE

### 35.1 Design Documentation

*ns-3* nodes can contain a collection of NetDevice objects, much like an actual computer contains separate interface cards for Ethernet, Wifi, Bluetooth, etc. This chapter describes the *ns-3* WifiNetDevice and related models. By adding WifiNetDevice objects to *ns-3* nodes, one can create models of 802.11-based infrastructure and ad hoc networks.

#### 35.1.1 Overview of the model

The WifiNetDevice models a wireless network interface controller based on the IEEE 802.11 standard [ieee80211]. We will go into more detail below but in brief, *ns-3* provides models for these aspects of 802.11:

- basic 802.11 DCF with **infrastructure** and **adhoc** modes
- **802.11a**, **802.11b**, **802.11g**, **802.11n** (both 2.4 and 5 GHz bands), **802.11ac** and **802.11ax** (2.4, 5 and 6 GHz bands) physical layers
- **MSDU aggregation** and **MPDU aggregation** extensions of 802.11n, and both can be combined together (two-level aggregation)
- QoS-based EDCA and queueing extensions of **802.11e**
- the ability to use different propagation loss models and propagation delay models, please see the chapter on *Propagation* for more detail
- packet error models and frame detection models that have been validated against link simulations and other references
- various rate control algorithms including **Aarf**, **Arf**, **Cara**, **Onoe**, **Rraa**, **ConstantRate**, **Minstrel** and **Minstrel-HT**
- 802.11s (mesh), described in another chapter
- 802.11p and WAVE (vehicular), described in another chapter

The set of 802.11 models provided in *ns-3* attempts to provide an accurate MAC-level implementation of the 802.11 specification and to provide a packet-level abstraction of the PHY-level for different PHYs, corresponding to 802.11a/b/e/g/n/ac/ax specifications.

In *ns-3*, nodes can have multiple WifiNetDevices on separate channels, and the WifiNetDevice can coexist with other device types. With the use of the **SpectrumWifiPhy** framework, one can also build scenarios involving cross-channel interference or multiple wireless technologies on a single channel.

The source code for the WifiNetDevice and its models lives in the directory `src/wifi`.

The implementation is modular and provides roughly three sublayers of models:

- the **PHY layer models**
- the so-called **MAC low models**: they model functions such as medium access (DCF and EDCA), RTS/CTS and ACK. In *ns-3*, the lower-level MAC is further subdivided into a **MAC low** and **MAC middle** sublayering, with channel access grouped into the **MAC middle**.
- the so-called **MAC high models**: they implement non-time-critical processes in Wifi such as the MAC-level beacon generation, probing, and association state machines, and a set of **Rate control algorithms**. In the literature, this sublayer is sometimes called the **upper MAC** and consists of more software-oriented implementations vs. time-critical hardware implementations.

Next, we provide an design overview of each layer, shown in Figure *WifiNetDevice architecture..*

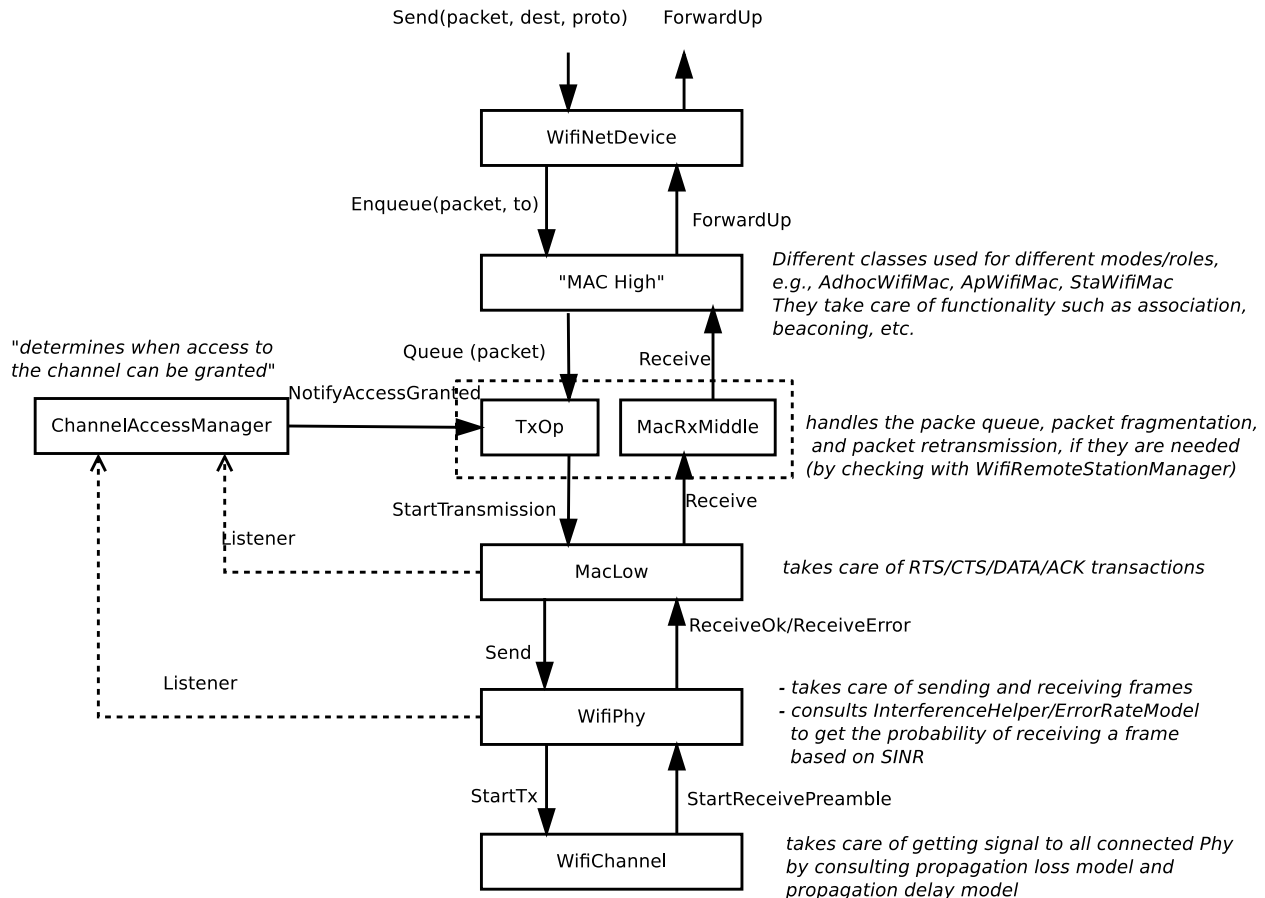

Fig. 1: WifiNetDevice architecture.

## MAC high models

There are presently three **MAC high models** that provide for the three (non-mesh; the mesh equivalent, which is a sibling of these with common parent `ns3::RegularWifiMac`, is not discussed here) Wi-Fi topological elements - Access Point (AP) (`ns3::ApWifiMac`), non-AP Station (STA) (`ns3::StaWifiMac`), and STA in an Independent Basic Service Set (IBSS) - also commonly referred to as an ad hoc network (`ns3::AdhocWifiMac`).

The simplest of these is `ns3::AdhocWifiMac`, which implements a Wi-Fi MAC that does not perform any kind of beacon generation, probing, or association. The `ns3::StaWifiMac` class implements an active probing and association state machine that handles automatic re-association whenever too many beacons are missed. Finally, `ns3::ApWifiMac` implements an AP that generates periodic beacons, and that accepts every attempt to associate.



These three MAC high models share a common parent in `ns3::RegularWifiMac`, which exposes, among other MAC configuration, an attribute `QoSSupported` that allows configuration of 802.11e/WMM-style QoS support, an attribute `HtSupported` that allows configuration of 802.11n High Throughput style support, an attribute `VhtSupported` that allows configuration of 802.11ac Very High Throughput style support and an attribute `HeSupported` that allows configuration of 802.11ax High Efficiency style support.

There are also several **rate control algorithms** that can be used by the MAC low layer. A complete list of available rate control algorithms is provided in a separate section.

## MAC low layer

The **MAC low layer** is split into three main components:

1. `ns3::MacLow` which takes care of RTS/CTS/DATA/ACK transactions and also performs MPDU aggregation.
2. `ns3::ChannelAccessManager` and `ns3::DcfState` which implements the DCF and EDCAF functions.
3. `ns3::Txop` and `ns3::QoSTxop` which handle the packet queue, packet fragmentation, and packet retransmissions if they are needed. The `ns3::Txop` object is used by high MACs that are not QoS-enabled, and for transmission of frames (e.g., of type Management) that the standard says should access the medium using the DCF. `ns3::QoSTxop` is used by QoS-enabled high MACs and also performs MSDU aggregation.

## PHY layer models

In short, the physical layer models are mainly responsible for modeling the reception of packets and for tracking energy consumption. There are typically three main components to packet reception:

- each packet received is probabilistically evaluated for successful or failed reception. The probability depends on the modulation, on the signal to noise (and interference) ratio for the packet, and on the state of the physical layer (e.g. reception is not possible while transmission or sleeping is taking place);
- an object exists to track (bookkeeping) all received signals so that the correct interference power for each packet can be computed when a reception decision has to be made; and
- one or more error models corresponding to the modulation and standard are used to look up probability of successful reception.

*ns-3* offers users a choice between two physical layer models, with a base interface defined in the `ns3::WifiPhy` class. The `YansWifiPhy` class implements a simple physical layer model, which is described in a paper entitled [Yet Another Network Simulator](#). The acronym *Yans* derives from this paper title. The `SpectrumWifiPhy` class is a more advanced implementation based on the Spectrum framework used for other *ns-3* wireless models. Spectrum allows a fine-grained frequency decomposition of the signal, and permits scenarios to include multiple technologies coexisting on the same channel.

### 35.1.2 Scope and Limitations

The IEEE 802.11 standard [ieee80211] is a large specification, and not all aspects are covered by *ns-3*; the documentation of *ns-3*'s conformance by itself would lead to a very long document. This section attempts to summarize compliance with the standard and with behavior found in practice.

The physical layer and channel models operate on a per-packet basis, with no frequency-selective propagation nor interference effects when using the default `YansWifiPhy` model. Directional antennas are also not supported at this time. For additive white Gaussian noise (AWGN) scenarios, or wideband interference scenarios, performance is governed by the application of analytical models (based on modulation and factors such as channel width) to the

received signal-to-noise ratio, where noise combines the effect of thermal noise and of interference from other Wi-Fi packets. Interference from other wireless technologies is only modeled when the SpectrumWifiPhy is used. The following details pertain to the physical layer and channel models:

- 802.11ax OFDMA is not supported (but some code changes are progressively being added)
- 802.11ac/ax MU-MIMO is not supported, and no more than 4 antennas can be configured
- 802.11n/ac/ax beamforming is not supported
- 802.11n RIFS is not supported
- 802.11 HCF/HCCA are not implemented
- 802.11 PCF implementation currently assumes a DTIM interval equal to the beacon interval
- Authentication and encryption are missing
- Processing delays are not modeled
- The current implementation assumes that secondary channels are always higher than primary channels
- Channel bonding implementation only supports the use of the configured channel width and does not perform CCA on secondary channels
- Cases where RTS/CTS and ACK are transmitted using HT/VHT/HE formats are not supported
- Energy consumption model does not consider MIMO

At the MAC layer, most of the main functions found in deployed Wi-Fi equipment for 802.11a/b/e/g/n/ac/ax are implemented, but there are scattered instances where some limitations in the models exist. Support for 802.11n, ac and ax is evolving.

Some implementation choices that are not imposed by the standard are listed below:

- BSSBasicRateSet for 802.11b has been assumed to be 1-2 Mbit/s
- BSSBasicRateSet for 802.11a/g has been assumed to be 6-12-24 Mbit/s
- The wifi manager always selects the lowest basic rate for management frames.

### 35.1.3 Design Details

The remainder of this section is devoted to more in-depth design descriptions of some of the Wi-Fi models. Users interested in skipping to the section on usage of the wifi module (*User Documentation*) may do so at this point. We organize these more detailed sections from the bottom-up, in terms of layering, by describing the channel and PHY models first, followed by the MAC models.

We focus first on the choice between physical layer frameworks. *ns-3* contains support for a Wi-Fi-only physical layer model called YansWifiPhy that offers no frequency-level decomposition of the signal. For simulations that involve only Wi-Fi signals on the Wi-Fi channel, and that do not involve frequency-dependent propagation loss or fading models, the default YansWifiPhy framework is a suitable choice. For simulations involving mixed technologies on the same channel, or frequency dependent effects, the SpectrumWifiPhy is more appropriate. The two frameworks are very similarly configured.

The SpectrumWifiPhy framework uses the *Spectrum Module* channel framework.

The YansWifiChannel is the only concrete channel model class in the *ns-3* wifi module. The `ns3::YansWifiChannel` implementation uses the propagation loss and delay models provided within the *ns-3 Propagation* module. In particular, a number of propagation models can be added (chained together, if multiple loss models are added) to the channel object, and a propagation delay model also added. Packets sent from a `ns3::YansWifiPhy` object onto the channel with a particular signal power, are copied to all of the other `ns3::YansWifiPhy` objects after

the signal power is reduced due to the propagation loss model(s), and after a delay corresponding to transmission (serialization) delay and propagation delay due to any channel propagation delay model (typically due to speed-of-light delay between the positions of the devices).

Only objects of `ns3::YansWifiPhy` may be attached to a `ns3::YansWifiChannel`; therefore, objects modeling other (interfering) technologies such as LTE are not allowed. Furthermore, packets from different channels do not interact; if a channel is logically configured for e.g. channels 5 and 6, the packets do not cause adjacent channel interference (even if their channel numbers overlap).

## WifiPhy and related models

The `ns3::WifiPhy` is an abstract base class representing the 802.11 physical layer functions. Packets passed to this object (via a `Send()` method) are sent over a channel object, and upon reception, the receiving PHY object decides (based on signal power and interference) whether the packet was successful or not. This class also provides a number of callbacks for notifications of physical layer events, exposes a notion of a state machine that can be monitored for MAC-level processes such as carrier sense, and handles sleep/wake/off models and energy consumption. The `ns3::WifiPhy` hooks to the `ns3::MacLow` object in the `WifiNetDevice`.

There are currently two implementations of the `WifiPhy`: the `ns3::YansWifiPhy` and the `ns3::SpectrumWifiPhy`. They each work in conjunction with three other objects:

- **WifiPhyStateHelper**: Maintains the PHY state machine
- **InterferenceHelper**: Tracks all packets observed on the channel
- **ErrorModel**: Computes a probability of error for a given SNR

## YansWifiPhy and WifiPhyStateHelper

Class `ns3::YansWifiPhy` is responsible for taking packets passed to it from the MAC (the `ns3::MacLow` object) and sending them onto the `ns3::YansWifiChannel` to which it is attached. It is also responsible to receive packets from that channel, and, if reception is deemed to have been successful, to pass them up to the MAC.

The energy of the signal intended to be received is calculated from the transmission power and adjusted based on the Tx gain of the transmitter, Rx gain of the receiver, and any path loss propagation model in effect.

Class `ns3::WifiPhyStateHelper` manages the state machine of the PHY layer, and allows other objects to hook as *listeners* to monitor PHY state. The main use of listeners is for the MAC layer to know when the PHY is busy or not (for transmission and collision avoidance).

The PHY layer can be in one of seven states:

1. TX: the PHY is currently transmitting a signal on behalf of its associated MAC
2. RX: the PHY is synchronized on a signal and is waiting until it has received its last bit to forward it to the MAC.
3. IDLE: the PHY is not in the TX, RX, or CCA\_BUSY states.
4. CCA\_BUSY: the PHY is not in TX or RX state but the measured energy is higher than the energy detection threshold.
5. SWITCHING: the PHY is switching channels.
6. SLEEP: the PHY is in a power save mode and cannot send nor receive frames.
7. OFF: the PHY is powered off and cannot send nor receive frames.

Packet reception works as follows. For `YansWifiPhy`, most of the logic is implemented in the `WifiPhy` base class. The `YansWifiChannel` calls `WifiPhy::StartReceivePreamble()` to start packet reception, but first there is a check of the packet's notional signal power level against a threshold value stored in the attribute

`WifiPhy::RxSensitivity`. Any packet with a power lower than `RxSensitivity` will be dropped with no further processing. The default value is -101 dBm, which is the thermal noise floor for 20 MHz signal at room temperature. The purpose of this attribute is two-fold: 1) very weak signals that will not affect the outcome will otherwise consume simulation memory and event processing, so they are discarded, and 2) this value can be adjusted upwards to function as a basic carrier sense threshold limitation for experiments involving spatial reuse considerations. Users are cautioned about the behavior of raising this threshold; namely, that all packets with power below this threshold will be discarded upon reception.

In `StartReceivePreamble ()`, the packet is immediately added to the interference helper for signal-to-noise tracking, and then further reception steps are decided upon the state of the PHY. In the case that the PHY is transmitting, for instance, the packet will be dropped. If the PHY is IDLE, or if the PHY is receiving and an optional `FrameCaptureModel` is being used (and the packet is within the capture window), then `WifiPhy::StartRx ()` is called next.

The `WifiPhy::StartRx ()` will typically schedule an event, `WifiPhy::StartReceiveHeader ()`, to occur at the notional end of the first OFDM symbol, to check whether the preamble has been detected. As of revisions to the model in ns-3.30, any state machine transitions from IDLE state are suppressed until after the preamble detection event.

The `StartReceiveHeader ()` method will check, with a preamble detection model, whether the signal is strong enough to be received, and if so, an event `WifiPhy::ContinueReceiveHeader ()` is scheduled for the end of the non-HT header and the PHY is put into the `CCA_BUSY` state. Currently, there is only a simple threshold-based preamble detection model in ns-3, called `ThresholdPreambleDetectionModel`. If there is no preamble detection model, the preamble is assumed to have been detected. It is important to note that, starting with the ns-3.30 release, the default in the `WifiPhyHelper` is to add the `ThresholdPreambleDetectionModel` with a threshold RSSI of -82 dBm, and a threshold SNR of 4 dB. Both the RSSI and SNR must be above these respective values for the preamble to be successfully detected. The default sensitivity has been reduced in ns-3.30 compared with that of previous releases, so some packet receptions that were previously successful will now fail on this check. More details on the modeling behind this change are provided in [lanante2019].

The next event to schedule is `StartReceivePayload ()` for the time at which the remaining PHY header fields have been received and the payload is about to start. This event is scheduled only if the non-HT PHY headers have been successfully received, otherwise the reception is aborted and PHY is put either in IDLE state or in `CCA_BUSY` state, depending on whether the measured energy is higher than the energy detection threshold.

The next event at `StartReceivePayload ()` checks, using the interference helper and error model, whether the header was successfully decoded, and if so, a `PhyRxPayloadBegin` callback (equivalent to the `PHY-RXSTART` primitive) is triggered. The PHY header is often transmitted at a lower modulation rate than is the payload. The portion of the packet corresponding to the PHY header is evaluated for probability of error based on the observed SNR. The `InterferenceHelper` object returns a value for “probability of error (PER)” for this header based on the SNR that has been tracked by the `InterferenceHelper`. The `YansWifiPhy` then draws a random number from a uniform distribution and compares it against the PER and decides success or failure. The process is again repeated after the payload has been received. If both the header and payload are successfully received, the packet is passed up to the `MacLow` object.

Even if packet objects received by the PHY are not part of the reception process, they are tracked by the `InterferenceHelper` object for purposes of SINR computation and making clear channel assessment decisions. If, in the course of reception, a packet is errored or dropped due to the PHY being in a state in which it cannot receive a packet, the packet is added to the interference helper, and the aggregate of the energy of all such signals is compared against an energy detection threshold to determine whether the PHY should enter a `CCA_BUSY` state. The `WifiPhy::CcaEdThreshold` attribute corresponds to what the standard calls the “ED threshold” for CCA Mode 1. In section 16.4.8.5 in the 802.11-2012 standard: “CCA Mode 1: Energy above threshold. CCA shall report a busy medium upon detection of any energy above the ED threshold.” By default, this value is set to the -62 dBm level specified in the standard for 20 MHz channels. When using `YansWifiPhy`, there are no non-Wi-Fi signals, so it is unlikely that this attribute would play much of a role in Yans wifi models if left at the default value, but if there is a strong Wi-Fi signal that is not otherwise being received by the model, it has the possibility to raise the `CCA_BUSY` while the overall energy exceeds this threshold.

The above describes the case in which the packet is a single MPDU. For more recent Wi-Fi standards using MPDU aggregation, `StartReceivePayload` schedules an event for reception of each individual MPDU (`ScheduleEndOfMpdus`), which then forwards each MPDU as they arrive up to `MacLow`, if the reception of the MPDU has been successful. Once the A-MPDU reception is finished, `MacLow` is also notified about the amount of successfully received MPDUs.

## InterferenceHelper

The `InterferenceHelper` is an object that tracks all incoming packets and calculates probability of error values for packets being received, and also evaluates whether energy on the channel rises above the CCA threshold.

The basic operation of probability of error calculations is shown in Figure *SNIR function over time*. Packets are represented as bits (not symbols) in the *ns-3* model, and the `InterferenceHelper` breaks the packet into one or more “chunks”, each with a different signal to noise (and interference) ratio (SNIR). Each chunk is separately evaluated by asking for the probability of error for a given number of bits from the error model in use. The `InterferenceHelper` builds an aggregate “probability of error” value based on these chunks and their duration, and returns this back to the `WifiPhy` for a reception decision.

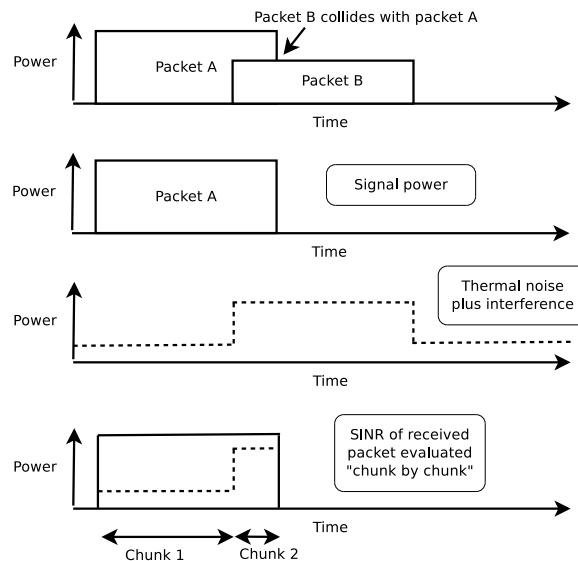

Fig. 2: *SNIR function over time*.

From the SNIR function we can derive the Bit Error Rate (BER) and Packet Error Rate (PER) for the modulation and coding scheme being used for the transmission.

If MIMO is used and the number of spatial streams is lower than the number of active antennas at the receiver, then a gain is applied to the calculated SNIR as follows (since STBC is not used):

$$\text{gain}(dB) = 10 \log\left(\frac{RX \text{ antennas}}{\text{spatial streams}}\right)$$

Having more TX antennas can be safely ignored for AWGN. The resulting gain is:

antennas	NSS	gain
2 x 1	1	0 dB
1 x 2	1	3 dB
2 x 2	1	3 dB
3 x 3	1	4.8 dB

(continues on next page)

(continued from previous page)

```

3 x 3      2      1.8 dB
3 x 3      3       0 dB
4 x 4      1       6 dB
4 x 4      2       3 dB
4 x 4      3      1.2 dB
4 x 4      4       0 dB
...

```

## ErrorRateModel

*ns-3* makes a packet error or success decision based on the input received SNR of a frame and based on any possible interfering frames that may overlap in time; i.e. based on the signal-to-noise (plus interference) ratio, or SINR. The relationship between packet error ratio (PER) and SINR in *ns-3* is defined by the `ns3::ErrorRateModel`, of which there are several. The PER is a function of the frame's modulation and coding (MCS), its SINR, and the specific `ErrorRateModel` configured for the MCS.

*ns-3* has updated its default `ErrorRateModel` over time. The current (as of ns-3.33 release) model for recent OFDM-based standards (i.e., 802.11n/ac/ax), is the `ns3::TableBasedErrorRateModel`. The default for 802.11a/g is the `ns3::YansErrorRateModel`, and the default for 802.11b is the `ns3::DsssErrorRateModel`. The error rate model for recent standards was updated during the ns-3.33 release cycle (previously, it was the `ns3::NistErrorRateModel`).

The error models are described in more detail in outside references. The current OFDM model is based on work published in [patidar2017], using link simulations results from the MATLAB WLAN Toolbox, and validated against IEEE TGn results [erceg2004]. For publications related to other error models, please refer to [pei80211ofdm], [pei80211b], [lacage2006yans], [Haccoun] and [Frenger] for a detailed description of the legacy PER models.

The current *ns-3* error rate models are for additive white gaussian noise channels (AWGN) only; any potential frequency-selective fading effects are not modeled.

In summary, there are four error models:

1. `ns3::TableBasedErrorRateModel`: for OFDM modes and reuses `ns3::DsssErrorRateModel` for 802.11b modes. This is the default for 802.11n/ac/ax.
2. `ns3::YansErrorRateModel`: for OFDM modes and reuses `ns3::DsssErrorRateModel` for 802.11b modes. This is the default for 802.11a/g.
3. `ns3::DsssErrorRateModel`: contains models for 802.11b modes. The 802.11b 1 Mbps and 2 Mbps error models are based on classical modulation analysis. If GNU Scientific Library (GSL) is installed, the 5.5 Mbps and 11 Mbps from [pursley2009] are used for CCK modulation; otherwise, results from a backup MATLAB-based CCK model are used.
4. `ns3::NistErrorRateModel`: for OFDM modes and reuses `ns3::DsssErrorRateModel` for 802.11b modes.

Users may select either NIST, YANS or Table-based models for OFDM, and DSSS will be used in either case for 802.11b. The NIST model was a long-standing default in ns-3 (through release 3.32).

## TableBasedErrorRateModel

The `ns3::TableBasedErrorRateModel` has been recently added and is now the *ns-3* default for 802.11n/ac/ax, while `ns3::YansErrorRateModel` is the *ns-3* default for 802.11a/g.

Unlike analytical error models based on error bounds, `ns3::TableBasedErrorRateModel` contains end-to-end link simulation tables (PER vs SNR) for AWGN channels. Since it is infeasible to generate such look-up tables for all

desired packet sizes and input SNRs, we adopt the recommendation of IEEE P802.11 TGax [porat2016] that proposed estimating PER for any desired packet length using BCC FEC encoding by extrapolating the results from two reference lengths: 32 (all lengths less than 400) bytes and 1458 (all lengths greater or equal to 400) bytes respectively. In case of LDPC FEC encoding, IEEE P802.11 TGax recommends the use of a single reference length. Hence, we provide two tables for BCC and one table for LDPC that are generated using a reliable and publicly available commercial link simulator (MATLAB WLAN Toolbox) for each modulation and coding scheme. Note that BCC tables are limited to MCS 9. For higher MCSs, the models fall back to the use of the YANS analytical model.

The validation scenario is set as follows:

1. Ideal channel and perfect channel estimation.
2. Perfect packet synchronization and detection.
3. Phase tracking, phase correction, phase noise, carrier frequency offset, power amplifier non-linearities etc. are not considered.

Several packets are simulated across the link to obtain PER, the number of packets needed to reliably estimate a PER value is computed using the consideration that ratio of the estimation error to the true value should be within 10 % with probability 0.95. For each SNR value (using 0.2 dB SNR resolution), simulations were run until either a minimum value of 400 unsuccessfully decoded packets were observed or a total of 40000 packets were simulated.

The obtained results are very close to original TGn curves as shown in Figure *Comparison of table-based OFDM Error Model with TGn results*.

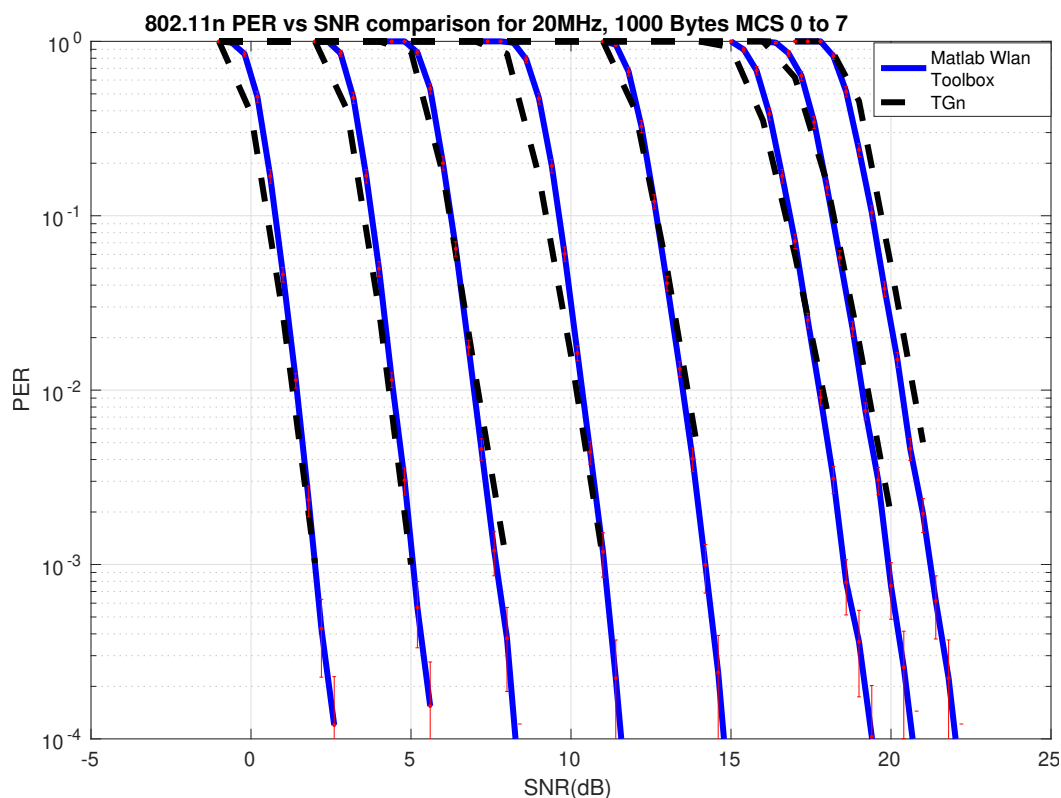

Fig. 3: Comparison of table-based OFDM Error Model with TGn results.

## Legacy ErrorRateModels

The original error rate model was called the `ns3::YansErrorRateModel` and was based on analytical results. For 802.11b modulations, the 1 Mbps mode is based on DBPSK. BER is from equation 5.2-69 from [proakis2001]. The 2 Mbps model is based on DQPSK. Equation 8 of [ferrari2004]. More details are provided in [lacage2006yans].

The `ns3::NistErrorRateModel` was later added. The model was largely aligned with the previous `ns3::YansErrorRateModel` for DSSS modulations 1 Mbps and 2 Mbps, but the 5.5 Mbps and 11 Mbps models were re-based on equations (17) and (18) from [pursley2009]. For OFDM modulations, newer results were obtained based on work previously done at NIST [miller2003]. The results were also compared against the CMU wireless network emulator, and details of the validation are provided in [pei80211ofdm]. Since OFDM modes use hard-decision of punctured codes, the coded BER is calculated using Chernoff bounds.

The 802.11b model was split from the OFDM model when the NIST error rate model was added, into a new model called `DsssErrorRateModel`.

Furthermore, the 5.5 Mbps and 11 Mbps models for 802.11b rely on library methods implemented in the GNU Scientific Library (GSL). The Waf build system tries to detect whether the host platform has GSL installed; if so, it compiles in the newer models from [pursley2009] for 5.5 Mbps and 11 Mbps; if not, it uses a backup model derived from MATLAB simulations.

The error curves for analytical models are shown to diverge from link simulation results for higher MCS in Figure *YANS and NIST error model comparison with TGn results*. This prompted the move to a new error model based on link simulations (the default `TableBasedErrorRateModel`, which provides curves close to those depicted by the TGn dashed line).

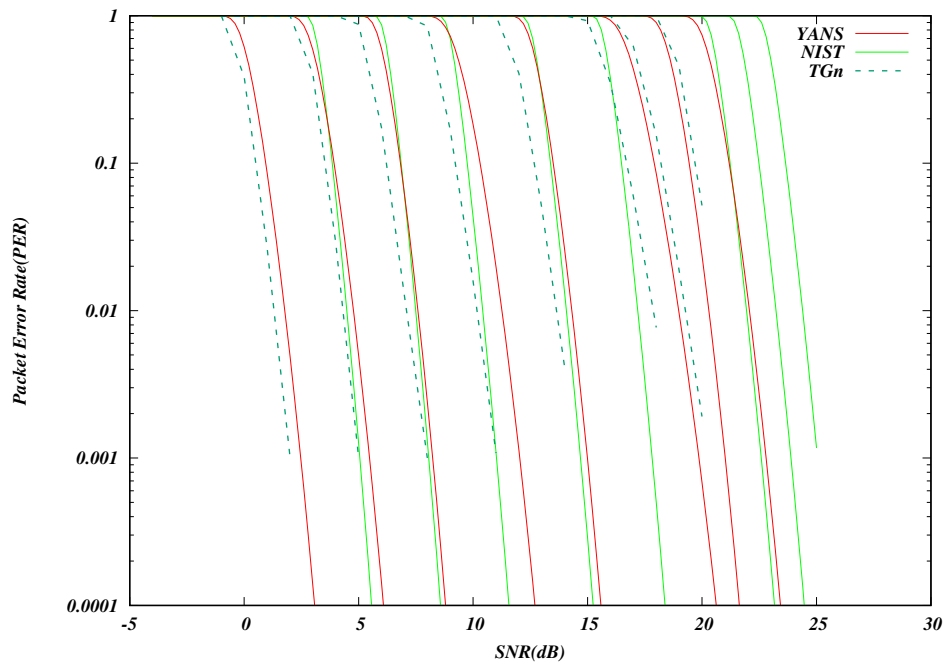

Fig. 4: *YANS and NIST error model comparison with TGn results*

## SpectrumWifiPhy

This section describes the implementation of the `SpectrumWifiPhy` class that can be found in `src/wifi/model/spectrum-wifi-phy.{cc,h}`.



The implementation also makes use of additional classes found in the same directory:

- `wifi-spectrum-phy-interface.{cc,h}`
- `wifi-spectrum-signal-parameters.{cc,h}`

and classes found in the spectrum module:

- `wifi-spectrum-value-helper.{cc,h}`

The current `SpectrumWifiPhy` class reuses the existing interference manager and error rate models originally built for `YansWifiPhy`, but allows, as a first step, foreign (non Wi-Fi) signals to be treated as additive noise.

Two main changes were needed to adapt the Spectrum framework to Wi-Fi. First, the physical layer must send signals compatible with the Spectrum channel framework, and in particular, the `MultiModelSpectrumChannel` that allows signals from different technologies to coexist. Second, the `InterferenceHelper` must be extended to support the insertion of non-Wi-Fi signals and to add their received power to the noise, in the same way that unintended Wi-Fi signals (perhaps from a different SSID or arriving late from a hidden node) are added to the noise.

Unlike `YansWifiPhy`, where there are no foreign signals, `CCA_BUSY` state will be raised for foreign signals that are higher than `CcaEdThreshold` (see section 16.4.8.5 in the 802.11-2012 standard for definition of CCA Mode 1). The attribute `WifiPhy::CcaEdThreshold` therefore potentially plays a larger role in this model than in the `YansWifiPhy` model.

To support the Spectrum channel, the `YansWifiPhy` transmit and receive methods were adapted to use the Spectrum channel API. This required developing a few `SpectrumModel`-related classes. The class `WifiSpectrumValueHelper` is used to create Wi-Fi signals with the spectrum framework and spread their energy across the bands. The spectrum is sub-divided into sub-bands (the width of an OFDM subcarrier, which depends on the technology). The power allocated to a particular channel is spread across the sub-bands roughly according to how power would be allocated to sub-carriers. Adjacent channels are modeled by the use of OFDM transmit spectrum masks as defined in the standards.

To support an easier user configuration experience, the existing `YansWifi` helper classes (in `src/wifi/helper`) were copied and adapted to provide equivalent `SpectrumWifi` helper classes.

Finally, for reasons related to avoiding C++ multiple inheritance issues, a small forwarding class called `WifiSpectrumPhyInterface` was inserted as a shim between the `SpectrumWifiPhy` and the Spectrum channel. The `WifiSpectrumPhyInterface` calls a different `SpectrumWifiPhy::StartRx ()` method to start the reception process. This method performs the check of the signal power against the `WifiPhy::RxSensitivity` attribute and discards weak signals, and also checks if the signal is a Wi-Fi signal; non-Wi-Fi signals are added to the `InterferenceHelper` and can raise `CCA_BUSY` but are not further processed in the reception chain. After this point, valid Wi-Fi signals cause `WifiPhy::StartReceivePreamble` to be called, and the processing continues as described above.

## The MAC model

### Infrastructure association

Association in infrastructure mode is a high-level MAC function. Either active probing or passive scanning is used (default is passive scan). At the start of the simulation, Wi-Fi network devices configured as STA will attempt to scan the channel. Depends on whether passive or active scanning is selected, STA will attempt to gather beacons, or send a probe request and gather probe responses until the respective timeout occurs. The end result will be a list of candidate AP to associate to. STA will then try to associate to the best AP (i.e., best SNR).

If association is rejected by the AP for some reason, the STA will try to associate to the next best AP until the candidate list is exhausted which then sends STA to 'REFUSED' state. If this occurs, the simulation user will need to force reassociation retry in some way, perhaps by changing configuration (i.e. the STA will not persistently try to associate upon a refusal).

When associated, if the configuration is changed by the simulation user, the STA will try to reassociate with the existing AP.

If the number of missed beacons exceeds the threshold, the STA will notify the rest of the device that the link is down (association is lost) and restart the scanning process. Note that this can also happen when an association request fails without explicit refusal (i.e., the AP fails to respond to association request).

### Roaming

Roaming at layer-2 (i.e. a STA migrates its association from one AP to another) is not presently supported. Because of that, the Min/Max channel dwelling time implementation as described by the IEEE 802.11 standard [ieee80211] is also omitted, since it is only meaningful on the context of channel roaming.

### Channel access

The 802.11 Distributed Coordination Function is used to calculate when to grant access to the transmission medium. While implementing the DCF would have been particularly easy if we had used a recurring timer that expired every slot, we chose to use the method described in [ji2004sslswn] where the backoff timer duration is lazily calculated whenever needed since it is claimed to have much better performance than the simpler recurring timer solution.

The DCF basic access is described in section 10.3.4.2 of [ieee80211-2016].

- “A STA may transmit an MPDU when it is operating under the DCF access method [...] when the STA determines that the medium is idle when a frame is queued for transmission, and remains idle for a period of a DIFS, or an EIFS (10.3.2.3.7) from the end of the immediately preceding medium-busy event, whichever is the greater, and the backoff timer is zero. Otherwise the random backoff procedure described in 10.3.4.3 shall be followed.”

Thus, a station is allowed not to invoke the backoff procedure if all of the following conditions are met:

- the medium is idle when a frame is queued for transmission
- the medium remains idle until the most recent of these two events: a DIFS from the time when the frame is queued for transmission; an EIFS from the end of the immediately preceding medium-busy event (associated with the reception of an erroneous frame)
- the backoff timer is zero

The backoff procedure of DCF is described in section 10.3.4.3 of [ieee80211-2016].

- “A STA shall invoke the backoff procedure to transfer a frame when finding the medium busy as indicated by either the physical or virtual CS mechanism.”
- “A backoff procedure shall be performed immediately after the end of every transmission with the More Fragments bit set to 0 of an MPDU of type Data, Management, or Control with subtype PS-Poll, even if no additional transmissions are currently queued.”

The EDCA backoff procedure is slightly different than the DCF backoff procedure and is described in section 10.22.2.2 of [ieee80211-2016]. The backoff procedure shall be invoked by an EDCAF when any of the following events occur:

- a frame is “queued for transmission such that one of the transmit queues associated with that AC has now become non-empty and any other transmit queues associated with that AC are empty; the medium is busy on the primary channel”
- “The transmission of the MPDU in the final PPDU transmitted by the TXOP holder during the TXOP for that AC has completed and the TXNAV timer has expired, and the AC was a primary AC”
- “The transmission of an MPDU in the initial PPDU of a TXOP fails [...] and the AC was a primary AC”
- “The transmission attempt collides internally with another EDCAF of an AC that has higher priority”

- (optionally) “The transmission by the TXOP holder of an MPDU in a non-initial PPDU of a TXOP fails”

Additionally, section 10.22.2.4 of [ieee80211-2016] introduces the notion of slot boundary, which basically occurs following  $SIFS + AIFSN * slotTime$  of idle medium after the last busy medium that was the result of a reception of a frame with a correct FCS or following  $EIFS - DIFS + AIFSN * slotTime + SIFS$  of idle medium after the last indicated busy medium that was the result of a frame reception that has resulted in FCS error, or following a  $slotTime$  of idle medium occurring immediately after any of these conditions.

On these specific slot boundaries, each EDCAF shall make a determination to perform one and only one of the following functions:

- Decrement the backoff timer.
- Initiate the transmission of a frame exchange sequence.
- Invoke the backoff procedure due to an internal collision.
- Do nothing.

Thus, if an EDCAF decrements its backoff timer on a given slot boundary and, as a result, the backoff timer has a zero value, the EDCAF cannot immediately transmit, but it has to wait for another  $slotTime$  of idle medium before transmission can start.

The higher-level MAC functions are implemented in a set of other C++ classes and deal with:

- packet fragmentation and defragmentation,
- use of the RTS/CTS protocol,
- rate control algorithm,
- connection and disconnection to and from an Access Point,
- the MAC transmission queue,
- beacon generation,
- MSDU aggregation,
- etc.

## Rate control algorithms

Multiple rate control algorithms are available in *ns-3*. Some rate control algorithms are modeled after real algorithms used in real devices; others are found in literature. The following rate control algorithms can be used by the MAC low layer:

Algorithms found in real devices:

- `ArfWifiManager` (default for `WifiHelper`)
- `OnoeWifiManager`
- `ConstantRateWifiManager`
- `MinstrelWifiManager`
- `MinstrelHtWifiManager`

Algorithms in literature:

- `IdealWifiManager`
- `AarfWifiManager` [lacage2004aarfamrr]
- `AmrrWifiManager` [lacage2004aarfamrr]

- `CaraWifiManager` [kim2006cara]
- `RraaWifiManager` [wong2006rraa]
- `AarfedWifiManager` [maguolo2008aarfed]
- `ParfWifiManager` [akella2007parf]
- `AparfWifiManager` [chevillat2005aparf]

### ConstantRateWifiManager

The constant rate control algorithm always uses the same transmission mode for every packet. Users can set a desired ‘DataMode’ for all ‘unicast’ packets and ‘ControlMode’ for all ‘request’ control packets (e.g. RTS).

To specify different data mode for non-unicast packets, users must set the ‘NonUnicastMode’ attribute of the `WifiRemoteStationManager`. Otherwise, `WifiRemoteStationManager` will use a mode with the lowest rate for non-unicast packets.

The 802.11 standard is quite clear on the rules for selection of transmission parameters for control response frames (e.g. CTS and ACK). *ns-3* follows the standard and selects the rate of control response frames from the set of basic rates or mandatory rates. This means that control response frames may be sent using different rate even though the `ConstantRateWifiManager` is used. The `ControlMode` attribute of the `ConstantRateWifiManager` is used for RTS frames only. The rate of CTS and ACK frames are selected according to the 802.11 standard. However, users can still manually add `WifiMode` to the basic rate set that will allow control response frames to be sent at other rates. Please consult the [project wiki](#) on how to do this.

Available attributes:

- `DataMode` (default `WifiMode::OfdmRate6Mbps`): specify a mode for all non-unicast packets
- `ControlMode` (default `WifiMode::OfdmRate6Mbps`): specify a mode for all ‘request’ control packets

### IdealWifiManager

The ideal rate control algorithm selects the best mode according to the SNR of the previous packet sent. Consider node *A* sending a unicast packet to node *B*. When *B* successfully receives the packet sent from *A*, *B* records the SNR of the received packet into a `ns3::SnrTag` and adds the tag to an ACK back to *A*. By doing this, *A* is able to learn the SNR of the packet sent to *B* using an out-of-band mechanism (thus the name ‘ideal’). *A* then uses the SNR to select a transmission mode based on a set of SNR thresholds, which was built from a target BER and mode-specific SNR/BER curves.

Available attribute:

- `BerThreshold` (default 1e-6): The maximum Bit Error Rate that is used to calculate the SNR threshold for each mode.

Note that the `BerThreshold` has to be low enough to select a robust enough MCS (or mode) for a given SNR value, without being too restrictive on the target BER. Indeed we had noticed that the previous default value (i.e. 1e-5) led to the selection of HE MCS-11 which resulted in high PER. With this new default value (i.e. 1e-6), a HE STA moving away from a HE AP has smooth throughput decrease (whereas with 1e-5, better performance was seen further away, which is not “ideal”).

### MinstrelWifiManager

The minstrel rate control algorithm is a rate control algorithm originated from madwifi project. It is currently the default rate control algorithm of the Linux kernel.

Minstrel keeps track of the probability of successfully sending a frame of each available rate. Minstrel then calculates the expected throughput by multiplying the probability with the rate. This approach is chosen to make sure that lower rates are not selected in favor of the higher rates (since lower rates are more likely to have higher probability).

In minstrel, roughly 10 percent of transmissions are sent at the so-called lookaround rate. The goal of the lookaround rate is to force minstrel to try higher rate than the currently used rate.

For a more detailed information about minstrel, see [\[linuxminstrel\]](#).

## MinstrelHtWifiManager

This is the extension of minstrel for 802.11n/ac/ax.

## Ack policy selection

Since the introduction of the IEEE 802.11e amendment, multiple acknowledgment policies are available, which are coded in the Ack Policy subfield in the QoS Control field of QoS Data frames (see Section 9.2.4.5.4 of the IEEE 802.11-2016 standard). For instance, an A-MPDU can be sent with the *Normal Ack or Implicit Block Ack Request* policy, in which case the receiver replies with a Normal Ack or a Block Ack depending on whether the A-MPDU contains a single MPDU or multiple MPDUs, or with the *Block Ack* policy, in which case the receiver waits to receive a Block Ack Request in the future to which it replies with a Block Ack.

`WifiAckPolicySelector` is the abstract base class introduced to provide an interface for multiple ack policy selectors. Currently, the default ack policy selector is the `ConstantWifiAckPolicySelector`.

## ConstantWifiAckPolicySelector

The `ConstantWifiAckPolicySelector` allows to determine which acknowledgment policy to use depending on the value of its attributes:

- `UseExplicitBar`: used to determine the ack policy to use when a response is needed from the recipient and the current transmission includes multiple frames (A-MPDU) or there are frames transmitted previously for which an acknowledgment is needed. If this attribute is true, the *Block Ack* policy is used. Otherwise, the *Implicit Block Ack Request* policy is used.
- `BaThreshold`: used to determine when the originator of a Block Ack agreement needs to request a response from the recipient. A value of zero means that a response is requested at every frame transmission. Otherwise, a non-zero value (less than or equal to 1) means that a response is requested upon transmission of a frame whose sequence number is distant at least `BaThreshold` multiplied by the transmit window size from the starting sequence number of the transmit window.

## 802.11ax OBSS PD spatial reuse

802.11ax mode supports OBSS PD spatial reuse feature. OBSS PD stands for Overlapping Basic Service Set Preamble-Detection. OBSS PD is an 802.11ax specific feature that allows a STA, under specific conditions, to ignore an inter-BSS PPDU.

## OBSS PD Algorithm

`ObssPdAlgorithm` is the base class of OBSS PD algorithms. It implements the common functionalities. First, it makes sure the necessary callbacks are setup. Second, when a PHY reset is requested by the algorithm, it performs the computation to determine the TX power restrictions and informs the PHY object.

The PHY keeps tracks of incoming requests from the MAC to get access to the channel. If a request is received and if PHY reset(s) indicating TX power limitations occurred before a packet was transmitted, the next packet to be transmitted will be sent with a reduced power. Otherwise, no TX power restrictions will be applied.

### Constant OBSS PD Algorithm

Constant OBSS PD algorithm is a simple OBSS PD algorithm implemented in the `ConstantObssPdAlgorithm` class.

Once a HE preamble and its header have been received by the PHY, `ConstantObssPdAlgorithm::ReceiveHeSig` is triggered. The algorithm then checks whether this is an OBSS frame by comparing its own BSS color with the BSS color of the received preamble. If this is an OBSS frame, it compares the received RSSI with its configured OBSS PD level value. The PHY then gets reset to IDLE state in case the received RSSI is lower than that constant OBSS PD level value, and is informed about a TX power restrictions.

Note: since our model is based on a single threshold, the PHY only supports one restricted power level.

### Modifying Wifi model

Modifying the default wifi model is one of the common tasks when performing research. We provide an overview of how to make changes to the default wifi model in this section. Depending on your goal, the common tasks are (in no particular order):

- Creating or modifying the default Wi-Fi frames/headers by making changes to `wifi-mac-header.*`.
- MAC low modification. For example, handling new/modified control frames (think RTS/CTS/ACK/Block ACK), making changes to two-way transaction/four-way transaction. Users usually make changes to `mac-low.*` to accomplish this. Handling of control frames is performed in `MacLow::ReceiveOk`.
- MAC high modification. For example, handling new management frames (think beacon/probe), beacon/probe generation. Users usually make changes to `regular-wifi-mac.*`, `infrastructure-wifi-mac.*`, `“sta-wifi-mac.*”`, `ap-wifi-mac.*`, or `adhoc-wifi-mac.*` to accomplish this.
- Wi-Fi queue management. The files `txop.*` and `qos-txop.*` are of interest for this task.
- Channel access management. Users should modify the files `channel-access-manager.*`, which grant access to `Txop` and `QosTxop`.
- Fragmentation and RTS thresholds are handled by Wi-Fi remote station manager. Note that Wi-Fi remote station manager simply indicates if fragmentation and RTS are needed. Fragmentation is handled by `Txop` or `QosTxop` while RTS/CTS transaction is handled by `MacLow`.
- Modifying or creating new rate control algorithms can be done by creating a new child class of Wi-Fi remote station manager or modifying the existing ones.

## 35.2 User Documentation

### 35.2.1 Using the WifiNetDevice

The modularity provided by the implementation makes low-level configuration of the `WifiNetDevice` powerful but complex. For this reason, we provide some helper classes to perform common operations in a simple matter, and leverage the `ns-3` attribute system to allow users to control the parameterization of the underlying models.

Users who use the low-level `ns-3` API and who wish to add a `WifiNetDevice` to their node must create an instance of a `WifiNetDevice`, plus a number of constituent objects, and bind them together appropriately (the `WifiNetDevice` is very

modular in this regard, for future extensibility). At the low-level API, this can be done with about 20 lines of code (see `ns3::WifiHelper::Install`, and `ns3::YansWifiPhyHelper::Create`). They also must create, at some point, a `Channel`, which also contains a number of constituent objects (see `ns3::YansWifiChannelHelper::Create`).

However, a few helpers are available for users to add these devices and channels with only a few lines of code, if they are willing to use defaults, and the helpers provide additional API to allow the passing of attribute values to change default values. Commonly used attribute values are listed in the `Attributes` section. The scripts in `examples/wireless` can be browsed to see how this is done. Next, we describe the common steps to create a `WifiNetDevice` from the bottom layer (`Channel`) up to the device layer (`WifiNetDevice`).

To create a `WifiNetDevice`, users need to follow these steps:

- Decide on which physical layer framework, the `SpectrumWifiPhy` or `YansWifiPhy`, to use. This will affect which `Channel` and `Phy` type to use.
- Configure the `Channel`: `Channel` takes care of getting signal from one device to other devices on the same Wi-Fi channel. The main configurations of `WifiChannel` are propagation loss model and propagation delay model.
- Configure the `WifiPhy`: `WifiPhy` takes care of actually sending and receiving wireless signal from `Channel`. Here, `WifiPhy` decides whether each frame will be successfully decoded or not depending on the received signal strength and noise. Thus, the main configuration of `WifiPhy` is the error rate model, which is the one that actually calculates the probability of successfully decoding the frame based on the signal.
- Configure `WifiMac`: this step is more related to the architecture and device level. The users configure the wifi architecture (i.e. ad-hoc or ap-sta) and whether QoS (802.11e), HT (802.11n) and/or VHT (802.11ac) and/or HE (802.11ax) features are supported or not.
- Create `WifiDevice`: at this step, users configure the desired wifi standard (e.g. **802.11b**, **802.11g**, **802.11a**, **802.11n**, **802.11ac** or **802.11ax**) and rate control algorithm.
- Configure mobility: finally, a mobility model is (usually) required before `WifiNetDevice` can be used; even if the devices are stationary, their relative positions are needed for propagation loss calculations.

The following sample code illustrates a typical configuration using mostly default values in the simulator, and infrastructure mode:

```
NodeContainer wifiStaNode;
wifiStaNode.Create (10); // Create 10 station node objects
NodeContainer wifiApNode;
wifiApNode.Create (1); // Create 1 access point node object

// Create a channel helper and phy helper, and then create the channel
YansWifiChannelHelper channel = YansWifiChannelHelper::Default ();
YansWifiPhyHelper phy = YansWifiPhyHelper::Default ();
phy.SetChannel (channel.Create ());

// Create a WifiMacHelper, which is reused across STA and AP configurations
WifiMacHelper mac;

// Create a WifiHelper, which will use the above helpers to create
// and install Wifi devices. Configure a Wifi standard to use, which
// will align various parameters in the Phy and Mac to standard defaults.
WifiHelper wifi;
wifi.SetStandard (WIFI_STANDARD_80211n_5GHZ);
// Declare NetDeviceContainers to hold the container returned by the helper
NetDeviceContainer wifiStaDevices;
NetDeviceContainer wifiApDevice;

// Perform the installation
mac.SetType ("ns3::StaWifiMac");
```

(continues on next page)

(continued from previous page)

```
wifiStaDevices = wifi.Install (phy, mac, wifiStaNodes);
mac.SetType ("ns3::ApWifiMac");
wifiApDevice = wifi.Install (phy, mac, wifiApNode);
```

At this point, the 11 nodes have Wi-Fi devices configured, attached to a common channel. The rest of this section describes how additional configuration may be performed.

## YansWifiChannelHelper

The YansWifiChannelHelper has an unusual name. Readers may wonder why it is named this way. The reference is to the [yans simulator](#) from which this model is taken. The helper can be used to create a YansWifiChannel with a default PropagationLoss and PropagationDelay model.

Users will typically type code such as:

```
YansWifiChannelHelper wifiChannelHelper = YansWifiChannelHelper::Default ();
Ptr<Channel> wifiChannel = wifiChannelHelper.Create ();
```

to get the defaults. Specifically, the default is a channel model with a propagation delay equal to a constant, the speed of light (`ns3::ConstantSpeedPropagationDelayModel`), and a propagation loss based on a default log distance model (`ns3::LogDistancePropagationLossModel`), using a default exponent of 3. Please note that the default log distance model is configured with a reference loss of 46.6777 dB at reference distance of 1m. The reference loss of 46.6777 dB was calculated using Friis propagation loss model at 5.15 GHz. The reference loss must be changed if **802.11b**, **802.11g**, **802.11n** (at 2.4 GHz) or **802.11ax** (at 2.4 GHz) are used since they operate at 2.4 Ghz.

Note the distinction above in creating a helper object vs. an actual simulation object. In *ns-3*, helper objects (used at the helper API only) are created on the stack (they could also be created with operator new and later deleted). However, the actual *ns-3* objects typically inherit from `class ns3::Object` and are assigned to a smart pointer. See the chapter in the *ns-3* manual for a discussion of the *ns-3* object model, if you are not familiar with it.

The following two methods are useful when configuring YansWifiChannelHelper:

- `YansWifiChannelHelper::AddPropagationLoss` adds a `PropagationLossModel`; if one or more `PropagationLossModels` already exist, the new model is chained to the end
- `YansWifiChannelHelper::SetPropagationDelay` sets a `PropagationDelayModel` (not chainable)

## YansWifiPhyHelper

Physical devices (base class `ns3::WifiPhy`) connect to `ns3::YansWifiChannel` models in *ns-3*. We need to create `WifiPhy` objects appropriate for the `YansWifiChannel`; here the `YansWifiPhyHelper` will do the work.

The `YansWifiPhyHelper` class configures an object factory to create instances of a `YansWifiPhy` and adds some other objects to it, including possibly a supplemental `ErrorRateModel` and a pointer to a `MobilityModel`. The user code is typically:

```
YansWifiPhyHelper wifiPhyHelper;
wifiPhyHelper.SetChannel (wifiChannel);
```

The default `YansWifiPhyHelper` is configured with `TableBasedErrorRateModel` (`ns3::TableBasedErrorRateModel`). You can change the error rate model by calling the `YansWifiPhyHelper::SetErrorRateModel` method.

Optionally, if pcap tracing is needed, a user may use the following command to enable pcap tracing:



```
YansWifiPhyHelper::SetPcapDataLinkType (enum SupportedPcapDataLinkTypes dlt)
```

ns-3 supports RadioTap and Prism tracing extensions for 802.11.

Note that we haven't actually created any WifiPhy objects yet; we've just prepared the YansWifiPhyHelper by telling it which channel it is connected to. The Phy objects are created in the next step.

In order to enable 802.11n/ac/ax MIMO, the number of antennas as well as the number of supported spatial streams need to be configured. For example, this code enables MIMO with 2 antennas and 2 spatial streams:

```
wifiPhyHelper.Set ("Antennas", UintegerValue (2));
wifiPhyHelper.Set ("MaxSupportedTxSpatialStreams", UintegerValue (2));
wifiPhyHelper.Set ("MaxSupportedRxSpatialStreams", UintegerValue (2));
```

It is also possible to configure less streams than the number of antennas in order to benefit from diversity gain, and to define different MIMO capabilities for downlink and uplink. For example, this code configures a node with 3 antennas that supports 2 spatial streams in downstream and 1 spatial stream in upstream:

```
wifiPhyHelper.Set ("Antennas", UintegerValue (3));
wifiPhyHelper.Set ("MaxSupportedTxSpatialStreams", UintegerValue (2));
wifiPhyHelper.Set ("MaxSupportedRxSpatialStreams", UintegerValue (1));
```

802.11n PHY layer can support both 20 (default) or 40 MHz channel width, and 802.11ac/ax PHY layer can use either 20, 40, 80 (default) or 160 MHz channel width. See below for further documentation on setting the frequency, channel width, and channel number.

```
WifiHelper wifi;
wifi.SetStandard (WIFI_STANDARD_80211ac);
wifi.SetRemoteStationManager ("ns3::ConstantRateWifiManager",
                              "DataMode", StringValue ("VhtMcs9"),
                              "ControlMode", StringValue ("VhtMcs0"));

//Install PHY and MAC
Ssid ssid = Ssid ("ns3-wifi");
WifiMacHelper mac;

mac.SetType ("ns3::StaWifiMac",
            "Ssid", SsidValue (ssid),
            "ActiveProbing", BooleanValue (false));

NetDeviceContainer staDevice;
staDevice = wifi.Install (phy, mac, wifiStaNode);

mac.SetType ("ns3::ApWifiMac",
            "Ssid", SsidValue (ssid));

NetDeviceContainer apDevice;
apDevice = wifi.Install (phy, mac, wifiApNode);
```

## Channel, frequency, and channel width configuration

There are a few ns3::WifiPhy parameters that are related, and cannot be set completely independently, concerning the frequency and channel width that the device is tuned to. These are:

- WifiPhyStandard: For example, 802.11b, 802.11n, etc.
- Frequency

- ChannelWidth
- ChannelNumber

It is possible to set the above to incompatible combinations (e.g. channel number 1 with 40 MHz channel width on frequency 4915 MHz). In addition, the latter three values above are attributes; it is possible to set them in a number of ways:

- by setting global configuration default; e.g.

```
Config::SetDefault ("ns3::WifiPhy::ChannelNumber", UIntegerValue (3));
```

- by setting an attribute value in the helper; e.g.

```
YansWifiPhyHelper wifiPhyHelper = YansWifiPhyHelper::Default ();  
wifiPhyHelper.Set ("ChannelNumber", UIntegerValue (3));
```

- by setting the `WifiHelper::SetStandard` (enum `WifiStandard`) method; and
- by performing post-installation configuration of the option, either via a `Ptr` to the `WifiPhy` object, or through the `Config` namespace; e.g.:

```
Config::Set ("/NodeList/0/DeviceList/*/ns3::WifiNetDevice/Phy/ns3::WifiPhy/  
↪ChannelNumber",  
            UIntegerValue (3));
```

This section provides guidance on how to configure these settings in a coherent manner, and what happens if non-standard values are chosen.

### WifiHelper::SetStandard()

`WifiHelper::SetStandard ()` is a method to set various parameters in the `Mac` and `Phy` to standard values and some reasonable defaults. For example, `SetStandard (WIFI_STANDARD_80211a)` will set the `WifiPhy` to Channel 36 in the 5 GHz band, among other settings appropriate for 802.11a.

The following values for `WifiStandard` are defined in `src/wifi/model/wifi-standards.h`:

```
WIFI_STANDARD_80211a,  
WIFI_STANDARD_80211b,  
WIFI_STANDARD_80211g,  
WIFI_STANDARD_80211p,  
WIFI_STANDARD_holland,  
WIFI_STANDARD_80211n_2_4GHZ,  
WIFI_STANDARD_80211n_5GHZ,  
WIFI_STANDARD_80211ac,  
WIFI_STANDARD_80211ax_2_4GHZ,  
WIFI_STANDARD_80211ax_5GHZ,  
WIFI_STANDARD_80211ax_6GHZ
```

By default, the `WifiHelper` (the typical use case for `WifiPhy` creation) will configure the `WIFI_STANDARD_80211a` standard by default. Other values for standards should be passed explicitly to the `WifiHelper` object.

If user has not already separately configured `Frequency` or `ChannelNumber` when `SetStandard` is called, the user obtains default values, in addition (e.g. channel 1 for 802.11b/g, or channel 36 for a/n), in addition to an appropriate `ChannelWidth` value for the standard (typically, 20 MHz, but 80 MHz for 802.11ac/ax).

## WifiPhy attribute interactions

Users should keep in mind that the two attributes that matter most within the model code are `WifiPhy::Frequency` and `WifiPhy::ChannelWidth`; these are the ones directly used to set transmission parameters. `WifiPhy::ChannelNumber` and `WifiHelper::SetStandard()` are convenience shorthands for setting frequency and channel width. The `ns3::WifiPhy` contains code to keep these values aligned and to generate runtime errors in some cases if users set these attributes to incompatible values.

The pair (`WifiPhyStandard`, `ChannelNumber`) is an alias for a pair of (`Frequency/ChannelWidth`) items. Valid combinations are stored in a map within `WifiPhy` that is populated with well-known values but that can be dynamically extended at runtime.

### WifiPhy::Frequency

The `WifiPhy` channel center frequency is set by the attribute `Frequency` in the class `WifiPhy`. It is expressed in units of MHz. By default, this attribute is set to the value 0 to indicate that no value is configured.

Note that this is a change in definition from ns-3.25 and earlier releases, where this attribute referred to the start of the overall frequency band on which the channel resides, not the specific channel center frequency.

### WifiPhy::ChannelWidth

The `WifiPhy` channel width is set by the attribute `ChannelWidth` in the class `WifiPhy`. It is expressed in units of MHz. By default, this attribute is set to the value 20. Allowable values are 5, 10, 20, 22, 40, 80, or 160 (MHz).

### WifiPhy::ChannelNumber

Several channel numbers are defined and well-known in practice. However, valid channel numbers vary by geographical region around the world, and there is some overlap between the different standards.

In *ns-3*, the class `WifiPhy` contains an attribute `ChannelNumber` that is, by default, set to the value 0. The value 0 indicates that no channel number has been set by the user.

In *ns-3*, a `ChannelNumber` may be defined or unknown. These terms are not found in the code; they are just used to describe behavior herein.

If a `ChannelNumber` is defined, it means that `WifiPhy` has stored a map of `ChannelNumber` to the center frequency and channel width commonly known for that channel in practice. For example:

- Channel 1, when IEEE 802.11b is configured, corresponds to a channel width of 22 MHz and a center frequency of 2412 MHz.
- Channel 36, when IEEE 802.11n is configured at 5 GHz, corresponds to a channel width of 20 MHz and a center frequency of 5180 MHz.

The following channel numbers are well-defined for 2.4 GHz standards:

- channels 1-14 with `ChannelWidth` of 22 MHz for 802.11b
- channels 1-14 with `ChannelWidth` of 20 MHz for 802.11n-2.4GHz and 802.11g

The following channel numbers are well-defined for 5 GHz standards:

ChannelWidth	ChannelNumber
20 MHz	36, 40, 44, 48, 52, 56, 60, 64, 100, 104, 108, 112, 116, 120, 124, 128, 132, 136, 140, 144, 149, 153, 161, 165, 169
40 MHz	38, 46, 54, 62, 102, 110, 118, 126, 134, 142, 151, 159
80 MHz	42, 58, 106, 122, 138, 155
160 MHz	50, 114
10 MHz (802.11p)	172, 174, 176, 178, 180, 182, 184
5 MHz (802.11p)	171, 173, 175, 177, 179, 181, 183

The following channel numbers are well-defined for 6 GHz standards (802.11ax only):

ChannelWidth	ChannelNumber
20 MHz	1, 5, 9, 13, 17, 21, 25, 29, 33, 37, 41, 45, 49, 53, 57, 61, 65, 69, 73, 77, 81, 85, 89, 93, 97, 101, 105, 109, 113, 117, 121, 125, 129, 133, 137, 141, 145, 149, 153, 157, 161, 165, 169, 173, 177, 181, 185, 189, 193, 197, 201, 205, 209, 213, 217, 221, 225, 229, 233
40 MHz	3, 11, 19, 27, 35, 43, 51, 59, 67, 75, 83, 91, 99, 107, 115, 123, 131, 139, 147, 155, 163, 171, 179, 187, 195, 203, 211, 219, 227
80 MHz	7, 23, 39, 55, 71, 87, 103, 119, 135, 151, 167, 183, 199, 215
160 MHz	15, 47, 79, 111, 143, 175, 207

The channel number may be set either before or after creation of the WifiPhy object.

If an unknown channel number (other than zero) is configured, the simulator will exit with an error; for instance, such as:

```
Ptr<WifiPhy> wifiPhy = ...;
wifiPhy->SetAttribute ("ChannelNumber", UintegerValue (1321));
```

The known channel numbers are defined in the implementation file `src/wifi/model/wifi-phy.cc`. Of course, this file may be edited by users to extend to additional channel numbers. Below, we describe how new channel numbers may be defined dynamically at run-time.

If a known channel number is configured against an incorrect value of the WifiPhyStandard, the simulator will exit with an error; for instance, such as:

```
WifiHelper wifi;
wifi.SetStandard (WIFI_STANDARD_80211n_5GHZ);
...
Ptr<WifiPhy> wifiPhy = ...;
wifiPhy->SetAttribute ("ChannelNumber", UintegerValue (14));
```

In the above, while channel number 14 is well-defined in practice for 802.11b only, it is for 2.4 GHz band, not 5 GHz band.

## Defining a new channel number

Users may define their own channel number so that they can later refer to the channel by number.

The method is `WifiPhy::DefineChannelNumber ()` and it takes the following arguments:

- `uint16_t channelNumber`
- `enum WifiPhyStandard standard`

- uint32\_t frequency
- uint32\_t channelWidth

The pair of (channelNumber, standard) are used as an index to a map that returns a Frequency and ChannelWidth. By calling this method, one can dynamically add members to the map. For instance, let's suppose that you previously configured WIFI\_PHY\_STANDARD\_80211a, and wanted to define a new channel number '34' of width 20 MHz and at center frequency 5160 MHz.

If you try to simply configure ChannelNumber to the value 34, it will fail, since 34 is undefined. However, you can use DefineChannelNumber as follows:

```
Ptr<WifiPhy> wifiPhy = ...;
wifiPhy->DefineChannelNumber (34, WIFI_PHY_STANDARD_80211a, 5160, 20);
```

and then later you can refer to channel number 34 in your program, which will configure a center operating frequency of 5160 MHz and a width of 20 MHz.

The steps can be repeated to explicitly configure the same channel for multiple standards:

```
wifiPhy->DefineChannelNumber (34, WIFI_PHY_STANDARD_80211a, 5160, 20);
wifiPhy->DefineChannelNumber (34, WIFI_PHY_STANDARD_80211n_5GHZ, 5160, 20);
```

or for a wildcard, unspecified standard:

```
wifiPhy->DefineChannelNumber (34, WIFI_PHY_STANDARD_UNSPECIFIED, 5160, 20);
```

## Order of operation issues

Depending on the default values used and the order of operation in setting the values for the standard, channel width, frequency, and channel number, different configurations can be obtained. Below are some common use cases.

- **(accepting the standard defaults):** If a user has not already separately configured frequency or channel number when `WifiHelper::SetStandard ()` is called, the user gets default values (e.g. channel 1 for 802.11b/g/n, channel 36 for a/n with 20 MHz channel widths and channel 42 for ac/ax with 80 MHz channel widths)
- **(overwriting the standard channel):** If the user has previously configured (e.g. via `SetDefault`) either frequency or channel number when `SetStandard` is called, and the frequency or channel number are appropriate for the standard being configured, they are not overwritten
- **(changing the standard channel after Install):** The user may also call `WifiHelper::SetStandard ()` after `Install ()` and either configure the frequency to something different, or configure the channel number to something different. Note that if the channel number is undefined for the standard that was previously set, an error will occur.
- **(changing to non-standard frequency):** If the user configures a frequency outside the standardized frequency range for the current `WifiPhyStandard`, this is OK. This allows users to experiment with wifi on e.g. whitespace frequencies but still use `SetStandard` to set all of the other configuration details.
- **(interaction between channel number and frequency):** If the user sets Frequency to a different value than the currently configured ChannelNumber (or if ChannelNumber is zero), then the ChannelNumber is set to a new channel number if known, or to zero if unknown.
  - *example:* ChannelNumber previously set to 36, user sets Frequency to 5200, then ChannelNumber gets automatically set to 40
  - *example:* ChannelNumber set to 36, user later sets Frequency to 5185, ChannelNumber gets reset to 0

In summary, ChannelNumber and Frequency follow each other. ChannelNumber sets both Frequency and ChannelWidth if the channel number has been defined for the standard. Setting ChannelWidth has no effect on Frequency or ChannelNumber. Setting Frequency will set ChannelNumber to either the defined value for that Wi-Fi standard, or to the value 0 if undefined.

## SpectrumWifiPhyHelper

The API for this helper closely tracks the API of the YansWifiPhyHelper, with the exception that a channel of type `ns3::SpectrumChannel` instead of type `ns3::YansWifiChannel` must be used with it.

## WifiMacHelper

The next step is to configure the MAC model. We use WifiMacHelper to accomplish this. WifiMacHelper takes care of both the MAC low model and MAC high model, and configures an object factory to create instances of a `ns3::WifiMac`. It is used to configure MAC parameters like type of MAC, and to select whether 802.11/WMM-style QoS and/or 802.11n-style High Throughput (HT) and/or 802.11ac-style Very High Throughput (VHT) support and/or 802.11ax-style High Efficiency (HE) support are/is required.

By default, it creates an ad-hoc MAC instance that does not have 802.11e/WMM-style QoS nor 802.11n-style High Throughput (HT) nor 802.11ac-style Very High Throughput (VHT) nor 802.11ax-style High Efficiency (HE) support enabled.

For example the following user code configures a non-QoS and non-HT/non-VHT/non-HE MAC that will be a non-AP STA in an infrastructure network where the AP has SSID `ns-3-ssid`:

```
WifiMacHelper wifiMacHelper;
Ssid ssid = Ssid ("ns-3-ssid");
wifiMacHelper.SetType ("ns3::StaWifiMac",
                      "Ssid", SsidValue (ssid),
                      "ActiveProbing", BooleanValue (false));
```

The following code shows how to create an AP with QoS enabled:

```
WifiMacHelper wifiMacHelper;
wifiMacHelper.SetType ("ns3::ApWifiMac",
                      "Ssid", SsidValue (ssid),
                      "QosSupported", BooleanValue (true),
                      "BeaconGeneration", BooleanValue (true),
                      "BeaconInterval", TimeValue (Seconds (2.5)));
```

To create ad-hoc MAC instances, simply use `ns3::AdhocWifiMac` instead of `ns3::StaWifiMac` or `ns3::ApWifiMac`.

In infrastructure mode without QoS enabled, it is also possible to enable PCF support. The following code shows how to create a CF-pollable station:

```
WifiMacHelper wifiMacHelper;
wifiMacHelper.SetType ("ns3::StaWifiMac",
                      "Ssid", SsidValue (ssid),
                      "PcfSupported", BooleanValue (true));
```

PCF also supports an option to change the maximum duration of the contention-free period (which must be a multiple of 1024 microseconds). The following code shows how to create an AP with a custom PCF configuration:

```
WifiMacHelper wifiMacHelper;
wifiMacHelper.SetType ("ns3::ApWifiMac",
                      "Ssid", SsidValue (ssid),
                      "PcfSupported", BooleanValue (true),
                      "CfpMaxDuration", TimeValue (MicroSeconds (20480)));
```

With QoS-enabled MAC models it is possible to work with traffic belonging to four different Access Categories (ACs): **AC\_VO** for voice traffic, **AC\_VI** for video traffic, **AC\_BE** for best-effort traffic and **AC\_BK** for background traffic.

When selecting **802.11n** as the desired wifi standard, both 802.11e/WMM-style QoS and 802.11n-style High Throughput (HT) support gets enabled. Similarly when selecting **802.11ac** as the desired wifi standard, 802.11e/WMM-style QoS, 802.11n-style High Throughput (HT) and 802.11ac-style Very High Throughput (VHT) support gets enabled. And when selecting **802.11ax** as the desired wifi standard, 802.11e/WMM-style QoS, 802.11n-style High Throughput (HT), 802.11ac-style Very High Throughput (VHT) and 802.11ax-style High Efficiency (HE) support gets enabled.

For MAC instances that have QoS support enabled, the `ns3::WifiMacHelper` can be also used to set:

- block ack threshold (number of packets for which block ack mechanism should be used);
- block ack inactivity timeout.

For example the following user code configures a MAC that will be a non-AP STA with QoS enabled and a block ack threshold for AC\_BE set to 2 packets, in an infrastructure network where the AP has SSID `ns-3-ssid`:

```
WifiMacHelper wifiMacHelper;
Ssid ssid = Ssid ("ns-3-ssid");
wifiMacHelper.SetType ("ns3::StaWifiMac",
                      "Ssid", SsidValue (ssid),
                      "QosSupported", BooleanValue (true),
                      "BE_BlockAckThreshold", UIntegerValue (2),
                      "ActiveProbing", BooleanValue (false));
```

For MAC instances that have 802.11n-style High Throughput (HT) and/or 802.11ac-style Very High Throughput (VHT) and/or 802.11ax-style High Efficiency (HE) support enabled, the `ns3::WifiMacHelper` can be also used to set:

- MSDU aggregation parameters for a particular Access Category (AC) in order to use 802.11n/ac A-MSDU feature;
- MPDU aggregation parameters for a particular Access Category (AC) in order to use 802.11n/ac A-MPDU feature.

By default, MSDU aggregation feature is disabled for all ACs and MPDU aggregation is enabled for AC\_VI and AC\_BE, with a maximum aggregation size of 65535 bytes.

For example the following user code configures a MAC that will be a non-AP STA with HT and QoS enabled, MPDU aggregation enabled for AC\_VO with a maximum aggregation size of 65535 bytes, and MSDU aggregation enabled for AC\_BE with a maximum aggregation size of 7935 bytes, in an infrastructure network where the AP has SSID `ns-3-ssid`:

```
WifiHelper wifi;
wifi.SetStandard (WIFI_STANDARD_80211n_5GHZ);

WifiMacHelper wifiMacHelper;
Ssid ssid = Ssid ("ns-3-ssid");
wifiMacHelper.SetType ("ns3::StaWifiMac",
                      "Ssid", SsidValue (ssid),
                      "VO_MaxAmpduSize", UIntegerValue (65535),
                      "BE_MaxAmsduSize", UIntegerValue (7935),
                      "ActiveProbing", BooleanValue (false));
```

## Selection of the Access Category (AC)

Since ns-3.26, the QoS Tag is no longer used to assign a user priority to an MSDU. Instead, the selection of the Access Category (AC) for an MSDU is based on the value of the DS field in the IP header of the packet (ToS field in case of IPv4, Traffic Class field in case of IPv6). Details on how to set the ToS field of IPv4 packets are given in the *ToS (Type of Service)* section of the documentation. In summary, users can create an address of type `ns3::InetSocketAddress` with the desired type of service value and pass it to the application helpers:

```
InetSocketAddress destAddress (ipv4Address, udpPort);
destAddress.SetTos (tos);
OnOffHelper onoff ("ns3::UdpSocketFactory", destAddress);
```

Mapping the values of the DS field onto user priorities is performed similarly to the Linux mac80211 subsystem. Basically, the `ns3::WifiNetDevice::SelectQueue()` method sets the user priority (UP) of an MSDU to the three most significant bits of the DS field. The Access Category is then determined based on the user priority according to the following table:

UP	Access Category
7	AC_VO
6	AC_VO
5	AC_VI
4	AC_VI
3	AC_BE
0	AC_BE
2	AC_BK
1	AC_BK

TOS and DSCP values map onto user priorities and access categories according to the following table.

DiffServ PHB	TOS (binary)	UP	Access Category
EF	101110xx	5	AC_VI
AF11	001010xx	1	AC_BK
AF21	010010xx	2	AC_BK
AF31	011010xx	3	AC_BE
AF41	100010xx	4	AC_VI
AF12	001100xx	1	AC_BK
AF22	010100xx	2	AC_BK
AF32	011100xx	3	AC_BE
AF42	100100xx	4	AC_VI
AF13	001110xx	1	AC_BK
AF23	010110xx	2	AC_BK
AF33	011110xx	3	AC_BE
AF43	100110xx	4	AC_VI
CS0	000000xx	0	AC_BE
CS1	001000xx	1	AC_BK
CS2	010000xx	2	AC_BK
CS3	011000xx	3	AC_BE
CS4	100000xx	4	AC_VI
CS5	101000xx	5	AC_VI
CS6	110000xx	6	AC_VO
CS7	111000xx	7	AC_VO



So, for example,:

```
destAddress.SetTos (0xc0);
```

will map to CS6, User Priority 6, and Access Category AC\_VO. Also, the ns3-wifi-ac-mapping test suite (defined in src/test/ns3wifi/wifi-ac-mapping-test-suite.cc) can provide additional useful information.

Note that `ns3::WifiNetDevice::SelectQueue()` also sets the packet priority to the user priority, thus overwriting the value determined by the socket priority (users can read *Use of Send() vs. SendTo()* for details on how to set the packet priority). Also, given that the Traffic Control layer calls `ns3::WifiNetDevice::SelectQueue()` before enqueueing the packet into a queue disc, it turns out that queuing disciplines (such as `PfifoFastQueueDisc`) that classifies packets based on their priority will use the user priority instead of the socket priority.

## WifiHelper

We're now ready to create `WifiNetDevices`. First, let's create a `WifiHelper` with default settings:

```
WifiHelper wifiHelper;
```

What does this do? It sets the default wifi standard to **802.11a** and sets the `RemoteStationManager` to `ns3::ArfWifiManager`. You can change the `RemoteStationManager` by calling the `WifiHelper::SetRemoteStationManager` method. To change the wifi standard, call the `WifiHelper::SetStandard` method with the desired standard.

Now, let's use the `wifiPhyHelper` and `wifiMacHelper` created above to install `WifiNetDevices` on a set of nodes in a `NodeContainer` "c":

```
NetDeviceContainer wifiContainer = WifiHelper::Install (wifiPhyHelper, wifiMacHelper,
↳ c);
```

This creates the `WifiNetDevice` which includes also a `WifiRemoteStationManager`, a `WifiMac`, and a `WifiPhy` (connected to the matching `Channel`).

The `WifiHelper::SetStandard` method sets various default timing parameters as defined in the selected standard version, overwriting values that may exist or have been previously configured. In order to change parameters that are overwritten by `WifiHelper::SetStandard`, this should be done post-install using `Config::Set`:

```
WifiHelper wifi;
wifi.SetStandard (WIFI_STANDARD_80211n_2_4GHZ);
wifi.SetRemoteStationManager ("ns3::ConstantRateWifiManager", "DataMode", StringValue(
↳ "HtMcs7"), "ControlMode", StringValue("HtMcs0"));
```

```
//Install PHY and MAC
Ssid ssid = Ssid ("ns3-wifi");
```

```
WifiMacHelper mac;
mac.SetType ("ns3::StaWifiMac",
"SSid", SsidValue (ssid),
"ActiveProbing", BooleanValue (false));
```

```
NetDeviceContainer staDevice;
staDevice = wifi.Install (phy, mac, wifiStaNode);
```

```
mac.SetType ("ns3::ApWifiMac",
"SSid", SsidValue (ssid));
```

```
NetDeviceContainer apDevice;
```

(continues on next page)

(continued from previous page)

```

apDevice = wifi.Install (phy, mac, wifiApNode);

//Once install is done, we overwrite the standard timing values
Config::Set ("/NodeList/*/DeviceList*/$ns3::WifiNetDevice/Phy/Slot", TimeValue_
↳(MicroSeconds (slot)));
Config::Set ("/NodeList/*/DeviceList*/$ns3::WifiNetDevice/Phy/Sifs", TimeValue_
↳(MicroSeconds (sifs)));
Config::Set ("/NodeList/*/DeviceList*/$ns3::WifiNetDevice/Phy/Pifs", TimeValue_
↳(MicroSeconds (pifs)));

```

The `WifiHelper` can be used to set the attributes of the default ack policy selector (`ConstantWifiAckPolicySelector`) or to select a different (user provided) ack policy selector, for each of the available Access Categories. As an example, the following code can be used to set the `BaThreshold` attribute of the default ack policy selector associated with BE AC to 0.5:

```

WifiHelper wifi;
wifi.SetAckPolicySelectorForAc (AC_BE, "ns3::ConstantWifiAckPolicySelector",
↳"BaThreshold", DoubleValue (0.5));

```

The `WifiHelper` is also used to configure OBSS PD spatial reuse for 802.11ax. The following lines configure a `WifiHelper` to support OBSS PD spatial reuse using the `ConstantObssPdAlgorithm` with a threshold set to -72 dBm:

```

WifiHelper wifi;
wifi.SetObssPdAlgorithm ("ns3::ConstantObssPdAlgorithm",
↳"ObssPdLevel", DoubleValue (-72.0));

```

There are many other *ns-3* attributes that can be set on the above helpers to deviate from the default behavior; the example scripts show how to do some of this reconfiguration.

## HT configuration

HT is an acronym for High Throughput, a term synonymous with the IEEE 802.11n standard. Once the `ns3::WifiHelper::Install` has been called and the user sets the standard to a variant that supports HT capabilities (802.11n, 802.11ac, or 802.11ax), an HT configuration object will automatically be created for the device. The configuration object is used to store and manage HT-specific attributes.

802.11n/ac PHY layer can use either long (800 ns) or short (400 ns) OFDM guard intervals. To configure this parameter for a given device, the following lines of code could be used (in this example, it enables the support of a short guard interval for the first station):

```

Ptr<NetDevice> nd = wifiStaDevices.Get (0);
Ptr<WifiNetDevice> wnd = nd->GetObject<WifiNetDevice> ();
Ptr<HtConfiguration> htConfiguration = wnd->GetHtConfiguration ();
htConfiguration->SetShortGuardIntervalSupported (true);

```

It is also possible to configure HT-specific attributes using `Config::Set`. The following line of code enables the support of a short guard interval for all stations:

```

Config::Set ("/NodeList/DeviceList/$ns3::WifiNetDevice/HtConfiguration/ShortGuardIntervalSupported",
↳BooleanValue (true));

```

Furthermore, 802.11n provides an optional mode (Greenfield mode) to reduce preamble durations and which is only compatible with 802.11n devices. This mode is enabled as follows:

```
htConfiguration->SetGreenfieldSupported (true);
```

## VHT configuration

IEEE 802.11ac devices are also known as supporting Very High Throughput (VHT). Once the `ns3::WifiHelper::Install` has been called and either the 802.11ac or 802.11ax 5 GHz standards are configured, a VHT configuration object will be automatically created to manage VHT-specific attributes.

As of ns-3.29, however, there are no VHT-specific configuration items to manage; therefore, this object is a placeholder for future growth.

## HE configuration

IEEE 802.11ax is also known as High Efficiency (HE). Once the `ns3::WifiHelper::Install` has been called and IEEE 802.11ax configured as the standard, an HE configuration object will automatically be created to manage HE-specific attributes for 802.11ax devices.

802.11ax PHY layer can use either 3200 ns, 1600 ns or 800 ns OFDM guard intervals. To configure this parameter, the following lines of code could be used (in this example, it enables the support of 1600 ns guard interval), such as in this example code snippet:

```
Ptr<NetDevice> nd = wifiStaDevices.Get (0);
Ptr<WifiNetDevice> wnd = nd->GetObject<WifiNetDevice> ();
Ptr<HeConfiguration> heConfiguration = wnd->GetHeConfiguration ();
heConfiguration->SetGuardInterval (NanoSeconds (1600));
```

802.11ax allows extended compressed Block ACKs containing a 256-bits bitmap, making ↪ possible transmissions of A-MPDUs containing up to 256 MPDUs, depending on the negotiated buffer size. In order to configure the buffer size of an ↪ 802.11ax device, the following line of code could be used::

```
heConfiguration->SetMpduBufferSize (256);
```

For transmitting large MPDUs, it might also be needed to increase the maximum ↪ aggregation size (see above).

## Mobility configuration

Finally, a mobility model must be configured on each node with Wi-Fi device. Mobility model is used for calculating propagation loss and propagation delay. Two examples are provided in the next section. Users are referred to the chapter on *Mobility* module for detailed information.

## Example configuration

We provide two typical examples of how a user might configure a Wi-Fi network – one example with an ad-hoc network and one example with an infrastructure network. The two examples were modified from the two examples in the `examples/wireless` folder (`wifi-simple-adhoc.cc` and `wifi-simple-infra.cc`). Users are encouraged to see examples in the `examples/wireless` folder.

## AdHoc WifiNetDevice configuration

In this example, we create two ad-hoc nodes equipped with 802.11a Wi-Fi devices. We use the `ns3::ConstantSpeedPropagationDelayModel` as the propagation delay model and `ns3::LogDistancePropagationLossModel` with the exponent of 3.0 as the propagation loss model. Both devices are configured with `ConstantRateWifiManager` at the fixed rate of 12Mbps. Finally, we manually place them by using the `ns3::ListPositionAllocator`:

```
std::string phyMode ("OfdmRate12Mbps");

NodeContainer c;
c.Create (2);

WifiHelper wifi;
wifi.SetStandard (WIFI_STANDARD_80211a);

YansWifiPhyHelper wifiPhy = YansWifiPhyHelper::Default ();
// ns-3 supports RadioTap and Prism tracing extensions for 802.11
wifiPhy.SetPcapDataLinkType (WifiPhyHelper::DLT_IEEE802_11_RADIO);

YansWifiChannelHelper wifiChannel;
wifiChannel.SetPropagationDelay ("ns3::ConstantSpeedPropagationDelayModel");
wifiChannel.AddPropagationLoss ("ns3::LogDistancePropagationLossModel",
                               "Exponent", DoubleValue (3.0));
wifiPhy.SetChannel (wifiChannel.Create ());

// Add a non-QoS upper mac, and disable rate control (i.e. ConstantRateWifiManager)
WifiMacHelper wifiMac;
wifi.SetRemoteStationManager ("ns3::ConstantRateWifiManager",
                              "DataMode",StringValue (phyMode),
                              "ControlMode",StringValue (phyMode));

// Set it to adhoc mode
wifiMac.SetType ("ns3::AdhocWifiMac");
NetDeviceContainer devices = wifi.Install (wifiPhy, wifiMac, c);

// Configure mobility
MobilityHelper mobility;
Ptr<ListPositionAllocator> positionAlloc = CreateObject<ListPositionAllocator> ();
positionAlloc->Add (Vector (0.0, 0.0, 0.0));
positionAlloc->Add (Vector (5.0, 0.0, 0.0));
mobility.SetPositionAllocator (positionAlloc);
mobility.SetMobilityModel ("ns3::ConstantPositionMobilityModel");
mobility.Install (c);

// other set up (e.g. InternetStack, Application)
```

## Infrastructure (access point and clients) WifiNetDevice configuration

This is a typical example of how a user might configure an access point and a set of clients. In this example, we create one access point and two clients. Each node is equipped with 802.11b Wi-Fi device:

```
std::string phyMode ("DsssRate1Mbps");

NodeContainer ap;
ap.Create (1);
```

(continues on next page)

(continued from previous page)

```

NodeContainer sta;
sta.Create (2);

WifiHelper wifi;
wifi.SetStandard (WIFI_STANDARD_80211b);

YansWifiPhyHelper wifiPhy = YansWifiPhyHelper::Default ();
// ns-3 supports RadioTap and Prism tracing extensions for 802.11
wifiPhy.SetPcapDataLinkType (WifiPhyHelper::DLT_IEEE802_11_RADIO);

YansWifiChannelHelper wifiChannel;
// reference loss must be changed since 802.11b is operating at 2.4GHz
wifiChannel.SetPropagationDelay ("ns3::ConstantSpeedPropagationDelayModel");
wifiChannel.AddPropagationLoss ("ns3::LogDistancePropagationLossModel",
                               "Exponent", DoubleValue (3.0),
                               "ReferenceLoss", DoubleValue (40.0459));
wifiPhy.SetChannel (wifiChannel.Create ());

// Add a non-QoS upper mac, and disable rate control
WifiMacHelper wifiMac;
wifi.SetRemoteStationManager ("ns3::ConstantRateWifiManager",
                              "DataMode",StringValue (phyMode),
                              "ControlMode",StringValue (phyMode));

// Setup the rest of the upper mac
Ssid ssid = Ssid ("wifi-default");
// setup ap.
wifiMac.SetType ("ns3::ApWifiMac",
                "Ssid", SsidValue (ssid));
NetDeviceContainer apDevice = wifi.Install (wifiPhy, wifiMac, ap);
NetDeviceContainer devices = apDevice;

// setup sta.
wifiMac.SetType ("ns3::StaWifiMac",
                "Ssid", SsidValue (ssid),
                "ActiveProbing", BooleanValue (false));
NetDeviceContainer staDevice = wifi.Install (wifiPhy, wifiMac, sta);
devices.Add (staDevice);

// Configure mobility
MobilityHelper mobility;
Ptr<ListPositionAllocator> positionAlloc = CreateObject<ListPositionAllocator> ();
positionAlloc->Add (Vector (0.0, 0.0, 0.0));
positionAlloc->Add (Vector (5.0, 0.0, 0.0));
positionAlloc->Add (Vector (0.0, 5.0, 0.0));
mobility.SetPositionAllocator (positionAlloc);
mobility.SetMobilityModel ("ns3::ConstantPositionMobilityModel");
mobility.Install (ap);
mobility.Install (sta);

// other set up (e.g. InternetStack, Application)

```

## 35.3 Testing Documentation

At present, most of the available documentation about testing and validation exists in publications, some of which are referenced below.

### 35.3.1 Error model

Validation results for the 802.11b error model are available in this [technical report](#)

Two clarifications on the results should be noted. First, Figure 1-4 of the above reference corresponds to the *ns-3* NIST BER model. In the program in the Appendix of the paper (80211b.c), there are two constants used to generate the data. The first, packet size, is set to 1024 bytes. The second, “noise”, is set to a value of 7 dB; this was empirically picked to align the curves the best with the reported data from the CMU testbed. Although a value of 1.55 dB would correspond to the reported -99 dBm noise floor from the CMU paper, a noise figure of 7 dB results in the best fit with the CMU experimental data. This default of 7 dB is the `RxNoiseFigure` in the `ns3::YansWifiPhy` model. Other values for noise figure will shift the curves leftward or rightward but not change the slope.

The curves can be reproduced by running the `wifi-clear-channel-cmu.cc` example program in the `examples/wireless` directory, and the figure produced (when GNU Scientific Library (GSL) is enabled) is reproduced below in Figure *Clear channel (AWGN) error model for 802.11b*.

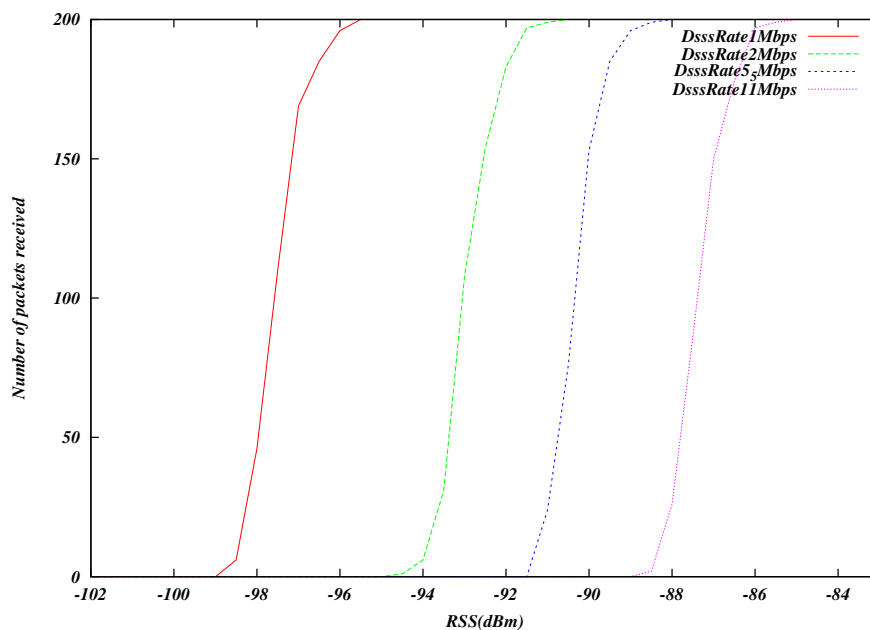

Fig. 5: Clear channel (AWGN) error model for 802.11b

Validation results for the 802.11a/g OFDM error model are available in this [technical report](#). The curves can be reproduced by running the `wifi-ofdm-validation.cc` example program in the `examples/wireless` directory, and the figure is reproduced below in Figure *Frame error rate (NIST model) for 802.11a/g (OFDM) Wi-Fi*.

Similar curves for 802.11n/ac/ax can be obtained by running the `wifi-ofdm-ht-validation.cc`, `wifi-ofdm-vht-validation.cc` and `wifi-ofdm-he-validation.cc` example programs in the `examples/wireless` directory, and the figures are reproduced below in Figure *Frame error rate (NIST model) for 802.11n (HT OFDM) Wi-Fi*, Figure *Frame error rate (NIST model) for 802.11ac (VHT OFDM) Wi-Fi* and Figure *Frame error rate (NIST model) for 802.11ax (HE OFDM) Wi-Fi*, respectively. There is no validation for those curves yet.

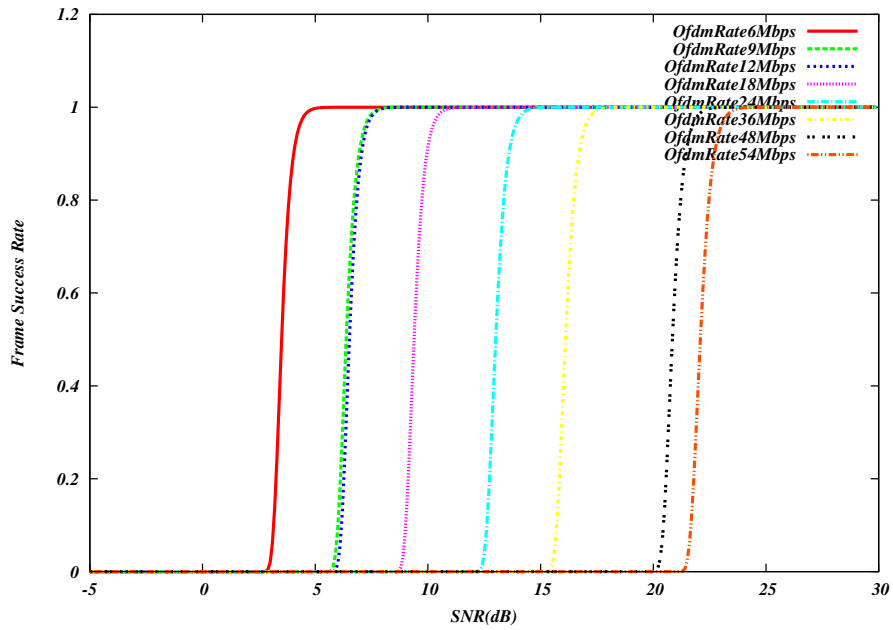

Fig. 6: Frame error rate (NIST model) for 802.11a/g (OFDM) Wi-Fi

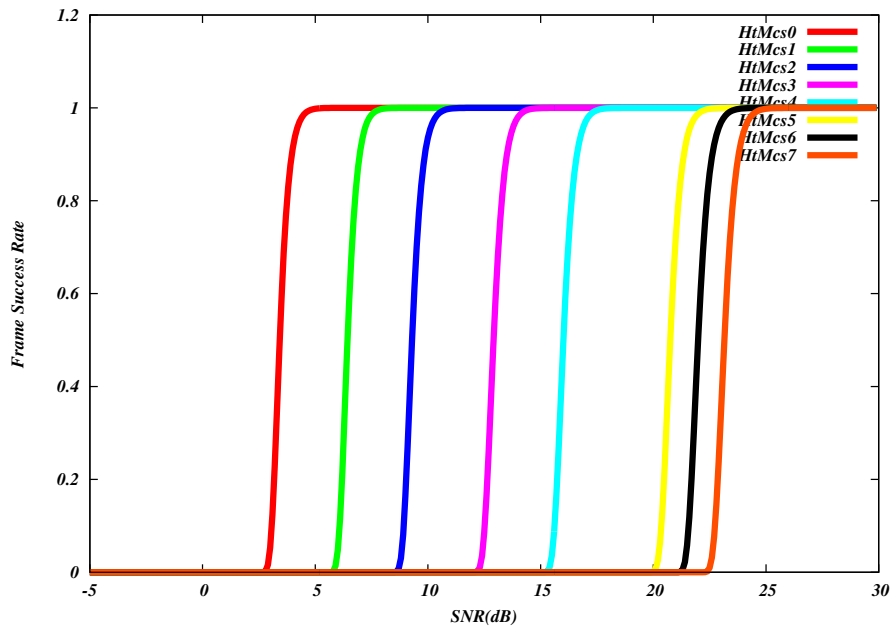

Fig. 7: Frame error rate (NIST model) for 802.11n (HT OFDM) Wi-Fi

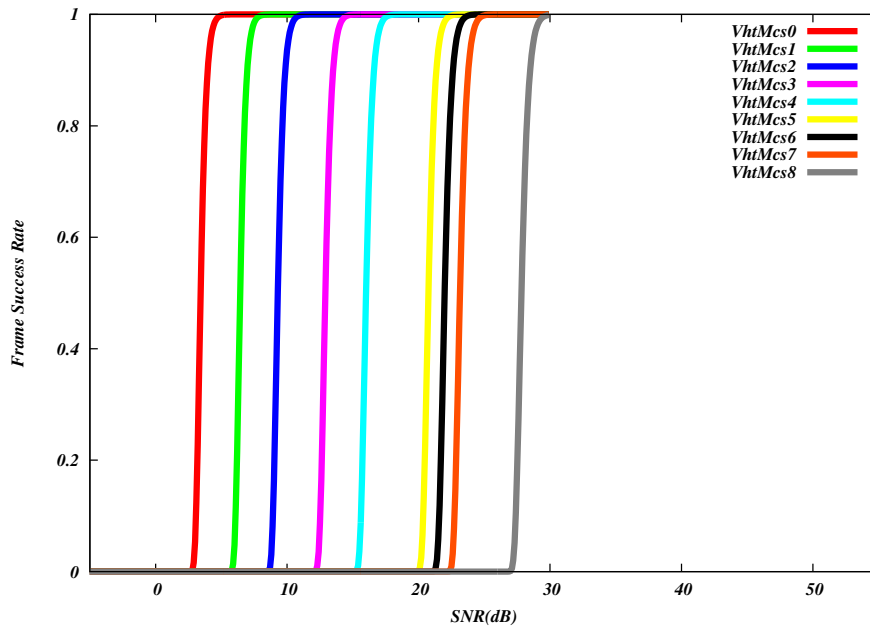

Fig. 8: Frame error rate (NIST model) for 802.11ac (VHT OFDM) Wi-Fi

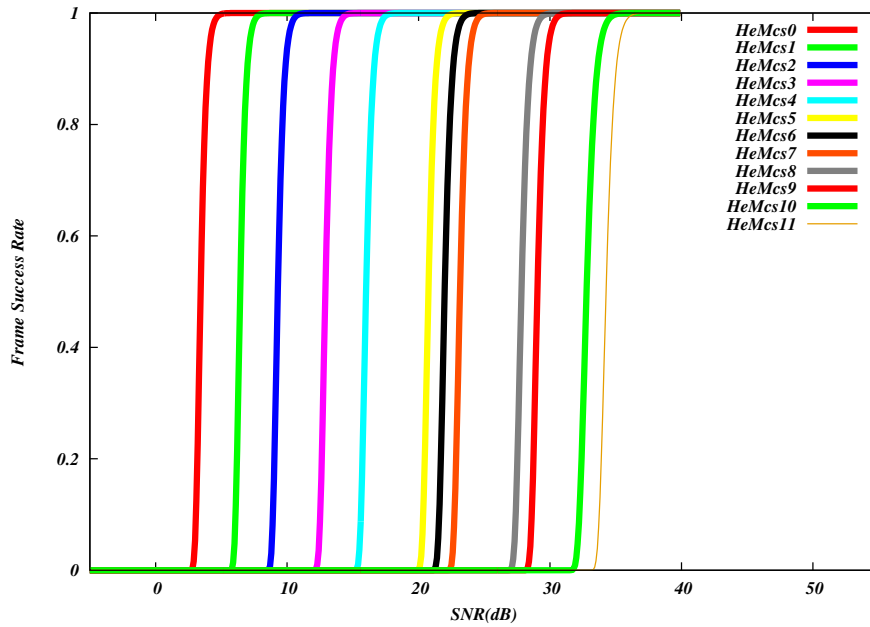

Fig. 9: Frame error rate (NIST model) for 802.11ax (HE OFDM) Wi-Fi



### 35.3.2 MAC validation

Validation of the 802.11 DCF MAC layer has been performed in [baldo2010].

802.11 PCF operation has been verified by running ‘wifi-pcf’ example with PCAP files generation enabled, and observing the frame exchange using Wireshark.

### 35.3.3 SpectrumWifiPhy

The SpectrumWifiPhy implementation has been verified to produce equivalent results to the legacy YansWifiPhy by using the saturation and packet error rate programs (described below) and toggling the implementation between the two physical layers.

A basic unit test is provided using injection of hand-crafted packets to a receiving Phy object, controlling the timing and receive power of each packet arrival and checking the reception results. However, most of the testing of this Phy implementation has been performed using example programs described below, and during the course of a (separate) LTE/Wi-Fi coexistence study not documented herein.

#### Saturation performance

The program `examples/wireless/wifi-spectrum-saturation-example.cc` allows user to select either the *SpectrumWifiPhy* or *YansWifiPhy* for saturation tests. The `wifiType` can be toggled by the argument `--wifiType=ns3::YansWifiPhy` or `--wifiType=ns3::SpectrumWifiPhy`

There isn’t any difference in the output, which is to be expected because this test is more of a test of the DCF than the physical layer.

By default, the program will use the *SpectrumWifiPhy* and will run for 10 seconds of saturating UDP data, with 802.11n features enabled. It produces this output for the main 802.11n rates (with short and long guard intervals):

```
wifiType: ns3::SpectrumWifiPhy distance: 1m
index   MCS   width Rate (Mb/s) Tput (Mb/s) Received
   0     0    20      6.5     5.81381    4937
   1     1    20     13     11.8266   10043
   2     2    20    19.5    17.7935   15110
   3     3    20     26    23.7958   20207
   4     4    20     39    35.7331   30344
   5     5    20     52    47.6174   40436
   6     6    20    58.5    53.6102   45525
   7     7    20     65    59.5501   50569
   ...
  63    15   40    300   254.902   216459
```

The above output shows the first 8 (of 32) modes, and last mode, that will be output from the program. The first 8 modes correspond to short guard interval disabled and channel bonding disabled. The subsequent 24 modes run by this program are variations with short guard interval enabled (cases 9-16), and then with channel bonding enabled and short guard first disabled then enabled (cases 17-32). Cases 33-64 repeat the same configurations but for two spatial streams (MIMO abstraction).

When run with the legacy *YansWifiPhy*, as in `./waf --run "wifi-spectrum-saturation-example --wifiType=ns3::YansWifiPhy"`, the same output is observed:

```
wifiType: ns3::YansWifiPhy distance: 1m
index   MCS   width Rate (Mb/s) Tput (Mb/s) Received
   0     0    20      6.5     5.81381    4937
   1     1    20     13     11.8266   10043
```

(continues on next page)

(continued from previous page)

```

2      2      20      19.5      17.7935      15110
3      3      20      26      23.7958      20207
...

```

This is to be expected since YansWifiPhy and SpectrumWifiPhy use the same error rate model in this case.

### Packet error rate performance

The program `examples/wireless/wifi-spectrum-per-example.cc` allows users to select either *SpectrumWifiPhy* or *YansWifiPhy*, as above, and select the distance between the nodes, and to log the reception statistics and received SNR (as observed by the `WifiPhy::MonitorSnifferRx` trace source), using a Friis propagation loss model. The transmit power is lowered from the default of 40 mW (16 dBm) to 1 dBm to lower the baseline SNR; the distance between the nodes can be changed to further change the SNR. By default, it steps through the same index values as in the saturation example (0 through 31) for a 50m distance, for 10 seconds of simulation time, producing output such as:

```

wifiType: ns3::SpectrumWifiPhy distance: 50m; time: 10; TxPower: 1 dBm (1.3 mW)
index  MCS  Rate (Mb/s) Tput (Mb/s) Received Signal (dBm) Noise (dBm) SNR (dB)
0      0      6.50      5.77      7414      -79.71      -93.97      14.25
1      1      13.00     11.58     14892     -79.71     -93.97     14.25
2      2      19.50     17.39     22358     -79.71     -93.97     14.25
3      3      26.00     22.96     29521     -79.71     -93.97     14.25
4      4      39.00      0.00      0          N/A        N/A        N/A
5      5      52.00      0.00      0          N/A        N/A        N/A
6      6      58.50      0.00      0          N/A        N/A        N/A
7      7      65.00      0.00      0          N/A        N/A        N/A

```

As in the above saturation example, running this program with *YansWifiPhy* will yield identical output.

### Interference performance

The program `examples/wireless/wifi-spectrum-per-interference.cc` is based on the previous packet error rate example, but copies over the `WaveformGenerator` from the unlicensed LTE interferer test, to allow users to inject a non-Wi-Fi signal (using the `--waveformPower` argument) from the command line. Another difference with respect to the packet error rate example program is that the transmit power is set back to the default of 40 mW (16 dBm). By default, the interference generator is off, and the program should behave similarly to the other packet error rate example, but by adding small amounts of power (e.g. `--waveformPower=0.001`), one will start to observe SNR degradation and frame loss.

Some sample output with default arguments (no interference) is:

```

./waf --run "wifi-spectrum-per-interference"

wifiType: ns3::SpectrumWifiPhy distance: 50m; time: 10; TxPower: 16 dBm (40 mW)
index  MCS  Rate (Mb/s) Tput (Mb/s) Received Signal (dBm) Noi+Inf(dBm) SNR (dB)
0      0      6.50      5.77      7414      -64.69     -93.97     29.27
1      1      13.00     11.58     14892     -64.69     -93.97     29.27
2      2      19.50     17.39     22358     -64.69     -93.97     29.27
3      3      26.00     23.23     29875     -64.69     -93.97     29.27
4      4      39.00     34.90     44877     -64.69     -93.97     29.27
5      5      52.00     46.51     59813     -64.69     -93.97     29.27
6      6      58.50     52.39     67374     -64.69     -93.97     29.27
7      7      65.00     58.18     74819     -64.69     -93.97     29.27
...

```

while a small amount of waveform power will cause frame losses to occur at higher order modulations, due to lower SNR:

```
./waf --run "wifi-spectrum-per-interference --waveformPower=0.001"
```

```
wifiType: ns3::SpectrumWifiPhy distance: 50m; sent: 1000 TxPower: 16 dBm (40 mW)
```

index	MCS	Rate (Mb/s)	Tput (Mb/s)	Received	Signal (dBm)	Noi+Inf (dBm)	SNR (dB)
0	0	6.50	5.77	7414	-64.69	-80.08	15.38
1	1	13.00	11.58	14892	-64.69	-80.08	15.38
2	2	19.50	17.39	22358	-64.69	-80.08	15.38
3	3	26.00	23.23	29873	-64.69	-80.08	15.38
4	4	39.00	0.41	531	-64.69	-80.08	15.38
5	5	52.00	0.00	0	N/A	N/A	N/A
6	6	58.50	0.00	0	N/A	N/A	N/A
7	7	65.00	0.00	0	N/A	N/A	N/A
...							

If ns3::YansWifiPhy is selected as the wifiType, the waveform generator will not be enabled because only transmitters of type YansWifiPhy may be connected to a YansWifiChannel.

The interference signal as received by the sending node is typically below the default -62 dBm CCA Mode 1 threshold in this example. If it raises above, the sending node will suppress all transmissions.

### 35.3.4 Bianchi validation

The program `src/wifi/examples/wifi-bianchi.cc` allows user to compare ns-3 simulation results against the Bianchi model presented in [bianchi2000] and [bianchi2005].

The MATLAB code used to generate the Bianchi model, as well as the generated outputs, are provided in the folder `src/wifi/examples/reference`. User can regenerate Bianchi results by running `generate_bianchi.m` in MATLAB.

By default, the program `src/wifi/examples/wifi-bianchi.cc` simulates an 802.11a adhoc ring scenario, with a PHY rate set to 54 Mbit/s, and loop from 5 stations to 50 stations, by a step of 5 stations. It generates a `plt` file, which allows user to quickly generate an `eps` file using `gnuplot` and visualize the graph.

```
./waf --run "wifi-bianchi"
```

The user has the possibility to select the standard (only 11a, 11b or 11g currently supported), to select the PHY rate (in Mbit/s), as well as to choose between an adhoc or an infrastructure configuration.

When run for 802.11g 6 Mbit/s in infrastructure mode, the output is:

```
./waf --run "wifi-bianchi --standard=11g --phyRate=6 --duration=500 --infra"
```

## 35.4 References

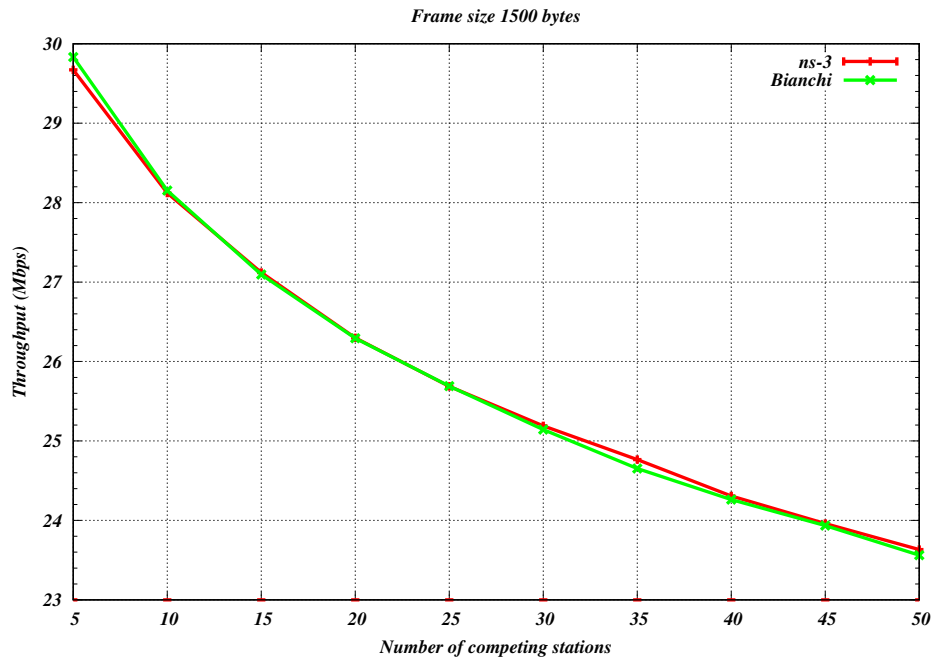

Fig. 10: Bianchi throughput validation results for 802.11a 54 Mbps in adhoc configuration

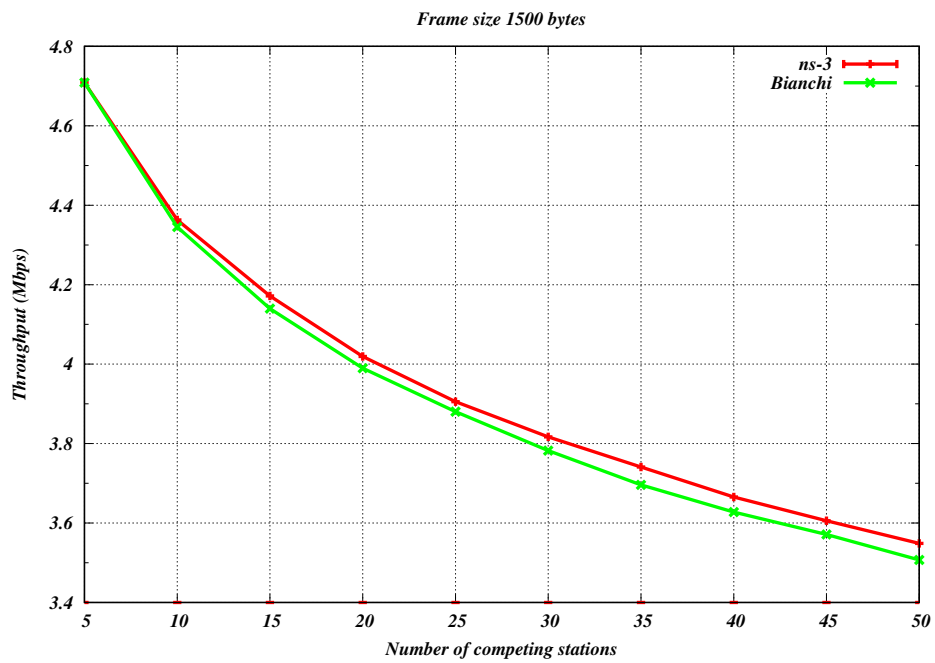

Fig. 11: Bianchi throughput validation results for 802.11g 6 Mbps in infrastructure configuration

## WIMAX NETDEVICE

This chapter describes the *ns-3* WimaxNetDevice and related models. By adding WimaxNetDevice objects to *ns-3* nodes, one can create models of 802.16-based networks. Below, we list some more details about what the *ns-3* WiMAX models cover but, in summary, the most important features of the *ns-3* model are:

- a scalable and realistic physical layer and channel model
- a packet classifier for the IP convergence sublayer
- efficient uplink and downlink schedulers
- support for Multicast and Broadcast Service (MBS), and
- packet tracing functionality

The source code for the WiMAX models lives in the directory `src/wimax`.

There have been two academic papers published on this model:

- M.A. Ismail, G. Piro, L.A. Grieco, and T. Turetletti, “An Improved IEEE 802.16 WiMAX Module for the NS-3 Simulator”, SIMUTools 2010 Conference, March 2010.
- J. Farooq and T. Turetletti, “An IEEE 802.16 WiMAX module for the NS-3 Simulator,” SIMUTools 2009 Conference, March 2009.

### 36.1 Scope of the model

From a MAC perspective, there are two basic modes of operation, that of a Subscriber Station (SS) or a Base Station (BS). These are implemented as two subclasses of the base class `ns3::NetDevice`, class `SubscriberStationNetDevice` and class `BaseStationNetDevice`. As is typical in *ns-3*, there is also a physical layer class `WimaxPhy` and a channel class `WimaxChannel` which serves to hold the references to all of the attached Phy devices. The main physical layer class is the `SimpleOfdmWimaxChannel` class.

Another important aspect of WiMAX is the uplink and downlink scheduler, and there are three primary scheduler types implemented:

- SIMPLE: a simple priority based FCFS scheduler
- RTPS: a real-time polling service (rtPS) scheduler
- MBQOS: a migration-based uplink scheduler

The following additional aspects of the 802.16 specifications, as well as physical layer and channel models, are modelled:

- leverages existing *ns-3* wireless propagation loss and delay models, as well as *ns-3* mobility models
- Point-to-Multipoint (PMP) mode and the WirelessMAN-OFDM PHY layer

- Initial Ranging
- Service Flow Initialization
- Management Connection
- Transport Initialization
- UGS, rtPS, nrtPS, and BE connections

The following aspects are not presently modelled but would be good topics for future extensions:

- OFDMA PHY layer
- Link adaptation
- Mesh topologies
- ARQ
- ertPS connection
- packet header suppression

## 36.2 Using the Wimax models

The main way that users who write simulation scripts will typically interact with the Wimax models is through the helper API and through the publicly visible attributes of the model.

The helper API is defined in `src/wimax/helper/wimax-helper.{cc,h}`.

The example `src/wimax/examples/wimax-simple.cc` contains some basic code that shows how to set up the model:

```
switch (schedType)
{
  case 0:
    scheduler = WimaxHelper::SCHED_TYPE_SIMPLE;
    break;
  case 1:
    scheduler = WimaxHelper::SCHED_TYPE_MBQOS;
    break;
  case 2:
    scheduler = WimaxHelper::SCHED_TYPE_RTSPS;
    break;
  default:
    scheduler = WimaxHelper::SCHED_TYPE_SIMPLE;
}
```

```
NodeContainer ssNodes;
NodeContainer bsNodes;
```

```
ssNodes.Create (2);
bsNodes.Create (1);
```

```
WimaxHelper wimax;
```

```
NetDeviceContainer ssDevs, bsDevs;
```

```
ssDevs = wimax.Install (ssNodes,
```

(continues on next page)

(continued from previous page)

```

WimaxHelper::DEVICE_TYPE_SUBSCRIBER_STATION,
WimaxHelper::SIMPLE_PHY_TYPE_OFDM,
scheduler);
bsDevs = wimax.Install (bsNodes, WimaxHelper::DEVICE_TYPE_BASE_STATION,
↳WimaxHelper::SIMPLE_PHY_TYPE_OFDM, scheduler);

```

This example shows that there are two subscriber stations and one base station created. The helper method `Install` allows the user to specify the scheduler type, the physical layer type, and the device type.

Different variants of `Install` are available; for instance, the example `src/wimax/examples/wimax-multicast.cc` shows how to specify a non-default channel or propagation model:

```

channel = CreateObject<SimpleOfdmWimaxChannel> ();
channel->SetPropagationModel (SimpleOfdmWimaxChannel::COST231_PROPAGATION);
ssDevs = wimax.Install (ssNodes,
WimaxHelper::DEVICE_TYPE_SUBSCRIBER_STATION,
WimaxHelper::SIMPLE_PHY_TYPE_OFDM,
channel,
scheduler);
Ptr<WimaxNetDevice> dev = wimax.Install (bsNodes.Get (0),
WimaxHelper::DEVICE_TYPE_BASE_STATION,
WimaxHelper::SIMPLE_PHY_TYPE_OFDM,
channel,
scheduler);

```

Mobility is also supported in the same way as in Wifi models; see the `src/wimax/examples/wimax-multicast.cc`.

Another important concept in WiMAX is that of a service flow. This is a unidirectional flow of packets with a set of QoS parameters such as traffic priority, rate, scheduling type, etc. The base station is responsible for issuing service flow identifiers and mapping them to WiMAX connections. The following code from `src/wimax/examples/wimax-multicast.cc` shows how this is configured from a helper level:

```

ServiceFlow MulticastServiceFlow = wimax.CreateServiceFlow (ServiceFlow::SF_DIRECTION_
↳DOWN,
ServiceFlow::SF_TYPE_UGS,
MulticastClassifier);

bs->GetServiceFlowManager ()->AddMulticastServiceFlow (MulticastServiceFlow,
↳WimaxPhy::MODULATION_TYPE_QPSK_12);

```

## 36.3 Wimax Attributes

The `WimaxNetDevice` makes heavy use of the *ns-3* attributes subsystem for configuration and default value management. Presently, approximately 60 values are stored in this system.

For instance, class `ns-3::SimpleOfdmWimaxPhy` exports these attributes:

- **NoiseFigure:** Loss (dB) in the Signal-to-Noise-Ratio due to non-idealities in the receiver.
- **TxPower:** Transmission power (dB)
- **G:** The ratio of CP time to useful time
- **txGain:** Transmission gain (dB)
- **RxGain:** Reception gain (dB)

- Nfft: FFT size
- TraceFilePath: Path to the directory containing SNR to block error rate files

For a full list of attributes in these models, consult the Doxygen page that lists all attributes for *ns-3*.

## 36.4 Wimax Tracing

*ns-3* has a sophisticated tracing infrastructure that allows users to hook into existing trace sources, or to define and export new ones.

Many *ns-3* users use the built-in Pcap or Ascii tracing, and the WimaxHelper has similar APIs:

```
AsciiTraceHelper ascii;
WimaxHelper wimax;
wimax.EnablePcap ("wimax-program", false);
wimax.EnableAsciiAll (ascii.CreateFileStream ("wimax-program.tr");
```

Unlike other helpers, there is also a special `EnableAsciiForConnection()` method that limits the ascii tracing to a specific device and connection.

These helpers access the low level trace sources that exist in the WiMAX physical layer, net device, and queue models. Like other *ns-3* trace sources, users may hook their own functions to these trace sources if they want to do customized things based on the packet events. See the Doxygen List of trace sources for a complete list of these sources.

## 36.5 Wimax MAC model

The 802.16 model provided in *ns-3* attempts to provide an accurate MAC and PHY level implementation of the 802.16 specification with the Point-to-Multipoint (PMP) mode and the WirelessMAN-OFDM PHY layer. The model is mainly composed of three layers:

- The convergence sublayer (CS)
- The MAC CP Common Part Sublayer (MAC-CPS)
- Physical (PHY) layer

The following figure *WiMAX architecture* shows the relationships of these models.

### 36.5.1 Convergence Sublayer

The Convergence sublayer (CS) provided with this module implements the Packet CS, designed to work with the packet-based protocols at higher layers. The CS is responsible of receiving packet from the higher layer and from peer stations, classifying packets to appropriate connections (or service flows) and processing packets. It keeps a mapping of transport connections to service flows. This enables the MAC CPS identifying the Quality of Service (QoS) parameters associated to a transport connection and ensuring the QoS requirements. The CS currently employs an IP classifier.

### 36.5.2 IP Packet Classifier

An IP packet classifier is used to map incoming packets to appropriate connections based on a set of criteria. The classifier maintains a list of mapping rules which associate an IP flow (src IP address and mask, dst IP address and mask, src port range, dst port range and protocol) to one of the service flows. By analyzing the IP and the TCP/UDP



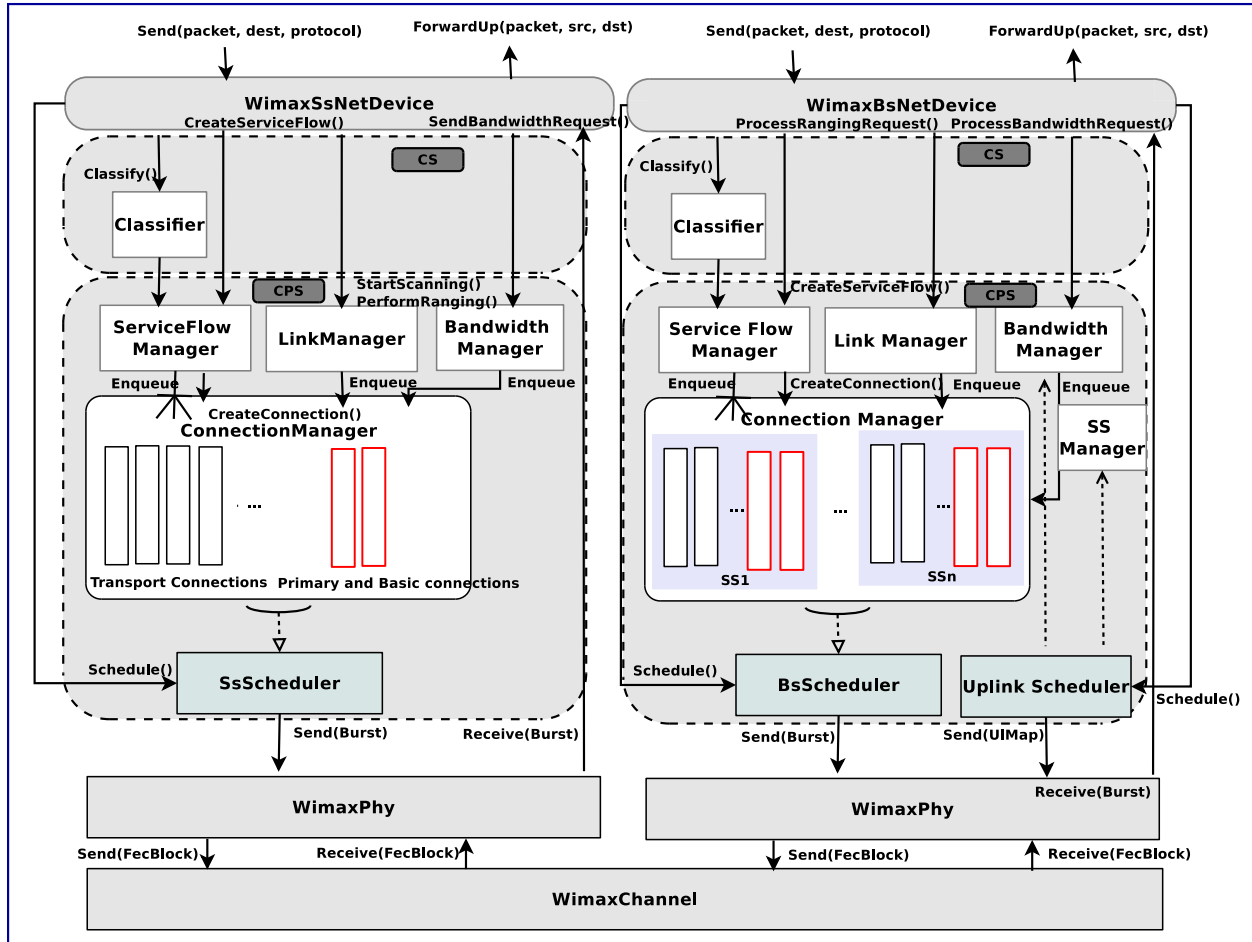

Fig. 1: WiMAX architecture

headers the classifier will append the incoming packet (from the upper layer) to the queue of the appropriate WiMAX connection. Class `IpcsClassifier` and class `IpcsClassifierRecord` implement the classifier module for both SS and BS

### 36.5.3 MAC Common Part Sublayer

The MAC Common Part Sublayer (CPS) is the main sublayer of the IEEE 802.16 MAC and performs the fundamental functions of the MAC. The module implements the Point-Multi-Point (PMP) mode. In PMP mode BS is responsible of managing communication among multiple SSs. The key functionalities of the MAC CPS include framing and addressing, generation of MAC management messages, SS initialization and registration, service flow management, bandwidth management and scheduling services. Class `WimaxNetDevice` represents the MAC layer of a WiMAX network device. This class extends the class `NetDevice` of the *ns-3* API that provides abstraction of a network device. Class `WimaxNetDevice` is further extended by class `BaseStationNetDevice` and class `SubscriberStationNetDevice`, defining MAC layers of BS and SS, respectively. Besides these main classes, the key functions of MAC are distributed to several other classes.

### 36.5.4 Framing and Management Messages

The module implements a frame as a fixed duration of time, i.e., frame boundaries are defined with respect to time. Each frame is further subdivided into downlink (DL) and uplink (UL) subframes. The module implements the Time Division Duplex (TDD) mode where DL and UL operate on same frequency but are separated in time. A number of DL and UL bursts are then allocated in DL and UL subframes, respectively. Since the standard allows sending and receiving bursts of packets in a given DL or UL burst, the unit of transmission at the MAC layer is a packet burst. The module implements a special `PacketBurst` data structure for this purpose. A packet burst is essentially a list of packets. The BS downlink and uplink schedulers, implemented by class `BSScheduler` and class `UplinkScheduler`, are responsible of generating DL and UL subframes, respectively. In the case of DL, the subframe is simulated by transmitting consecutive bursts (instances `PacketBurst`). In case of UL, the subframe is divided, with respect to time, into a number of slots. The bursts transmitted by the SSs in these slots are then aligned to slot boundaries. The frame is divided into integer number of symbols and Physical Slots (PS) which helps in managing bandwidth more effectively. The number of symbols per frame depends on the underlying implementation of the PHY layer. The size of a DL or UL burst is specified in units of symbols.

### 36.5.5 Network Entry and Initialization

The network entry and initialization phase is basically divided into two sub-phases, (1) scanning and synchronization and (2) initial ranging. The entire phase is performed by the `LinkManager` component of SS and BS. Once an SS wants to join the network, it first scans the downlink frequencies to search for a suitable channel. The search is complete as soon as it detects a PHY frame. The next step is to establish synchronization with the BS. Once SS receives a Downlink-MAP (DL-MAP) message the synchronization phase is complete and it remains synchronized as long as it keeps receiving DL-MAP and Downlink Channel Descriptor (DCD) messages. After the synchronization is established, SS waits for a Uplink Channel Descriptor (UCD) message to acquire uplink channel parameters. Once acquired, the first sub-phase of the network entry and initialization is complete. Once synchronization is achieved, the SS waits for a UL-MAP message to locate a special grant, called initial ranging interval, in the UL subframe. This grant is allocated by the BS Uplink Scheduler at regular intervals. Currently this interval is set to 0.5 ms, however the user is enabled to modify its value from the simulation script.

### 36.5.6 Connections and Addressing

All communication at the MAC layer is carried in terms of connections. The standard defines a connection as a unidirectional mapping between the SS and BS's MAC entities for the transmission of traffic. The standard defines two

types of connections: management connections for transmitting control messages and transport connections for data transmission. A connection is identified by a 16-bit Connection Identifier (CID). Class `WimaxConnection` and class `Cid` implement the connection and CID, respectively. Note that each connection maintains its own transmission queue where packets to transmit on that connection are queued. The `ConnectionManager` component of BS is responsible of creating and managing connections for all SSs.

The two key management connections defined by the standard, namely the Basic and Primary management connections, are created and allocated to the SS during the ranging process. Basic connection plays an important role throughout the operation of SS also because all (unicast) DL and UL grants are directed towards SS's Basic CID. In addition to management connections, an SS may have one or more transport connections to send data packets. The Connection Manager component of SS manages the connections associated to SS. As defined by the standard, a management connection is bidirectional, i.e., a pair of downlink and uplink connections is represented by the same CID. This feature is implemented in a way that one connection (in DL direction) is created by the BS and upon receiving the CID the SS then creates an identical connection (in UL direction) with the same CID.

### 36.5.7 Scheduling Services

The module supports the four scheduling services defined by the 802.16-2004 standard:

- Unsolicited Grant Service (UGS)
- Real-Time Polling Services (rtPS)
- Non Real-Time Polling Services (nrtPS)
- Best Effort (BE)

These scheduling services behave differently with respect to how they request bandwidth as well as how the it is granted. Each service flow is associated to exactly one scheduling service, and the QoS parameter set associated to a service flow actually defines the scheduling service it belongs to. When a service flow is created the `UplinkScheduler` calculates necessary parameters such as grant size and grant interval based on QoS parameters associated to it.

### 36.5.8 WiMAX Uplink Scheduler Model

Uplink Scheduler at the BS decides which of the SSs will be assigned uplink allocations based on the QoS parameters associated to a service flow (or scheduling service) and bandwidth requests from the SSs. Uplink scheduler together with Bandwidth Manager implements the complete scheduling service functionality. The standard defines up to four scheduling services (BE, UGS, rtPS, nrtPS) for applications with different types of QoS requirements. The service flows of these scheduling services behave differently with respect to how they request for bandwidth as well as how the bandwidth is granted. The module supports all four scheduling services. Each service flow is associated to exactly one transport connection and one scheduling service. The QoS parameters associated to a service flow actually define the scheduling service it belongs to. Standard QoS parameters for UGS, rtPS, nrtPS and BE services, as specified in Tables 111a to 111d of the 802.16e amendment, are supported. When a service flow is created the uplink scheduler calculates necessary parameters such as grant size and allocation interval based on QoS parameters associated to it. The current WiMAX module provides three different versions of schedulers.

- The first one is a simple priority-based First Come First Serve (FCFS). For the real-time services (UGS and rtPS) the BS then allocates grants/polls on regular basis based on the calculated interval. For the non real-time services (nrtPS and BE) only minimum reserved bandwidth is guaranteed if available after servicing real-time flows. Note that not all of these parameters are utilized by the uplink scheduler. Also note that currently only service flow with fixed-size packet size are supported, as currently set up in simulation scenario with OnOff application of fixed packet size. This scheduler is implemented by class `BSSchedulerSimple` and class `UplinkSchedulerSimple`.
- The second one is similar to first scheduler except by rtPS service flow. All rtPS Connections are able to transmit all packet in the queue according to the available bandwidth. The bandwidth saturation control has

been implemented to redistribute the effective available bandwidth to all rtPS that have at least one packet to transmit. The remaining bandwidth is allocated to nrtPS and BE Connections. This scheduler is implemented by class `BSSchedulerRtps` and class `UplinkSchedulerRtps`.

- The third one is a Migration-based Quality of Service uplink scheduler This uplink scheduler uses three queues, the low priority queue, the intermediate queue and the high priority queue. The scheduler serves the requests in strict priority order from the high priority queue to the low priority queue. The low priority queue stores the bandwidth requests of the BE service flow. The intermediate queue holds bandwidth requests sent by rtPS and by nrtPS connections. rtPS and nrtPS requests can migrate to the high priority queue to guarantee that their QoS requirements are met. Besides the requests migrated from the intermediate queue, the high priority queue stores periodic grants and unicast request opportunities that must be scheduled in the following frame. To guarantee the maximum delay requirement, the BS assigns a deadline to each rtPS bandwidth request in the intermediate queue. The minimum bandwidth requirement of both rtPS and nrtPS connections is guaranteed over a window of duration T. This scheduler is implemented by class `UplinkSchedulerMBQoS`.

### 36.5.9 WiMAX Outbound Schedulers Model

Besides the uplink scheduler these are the outbound schedulers at BS and SS side (`BSScheduler` and `SSScheduler`). The outbound schedulers decide which of the packets from the outbound queues will be transmitted in a given allocation. The outbound scheduler at the BS schedules the downlink traffic, i.e., packets to be transmitted to the SSs in the downlink subframe. Similarly the outbound scheduler at a SS schedules the packet to be transmitted in the uplink allocation assigned to that SS in the uplink subframe. All three schedulers have been implemented to work as FCFS scheduler, as they allocate grants starting from highest priority scheduling service to the lower priority one (UGS> rtPS> nrtPS> BE). The standard does not suggest any scheduling algorithm and instead leaves this decision up to the manufacturers. Of course more sophisticated algorithms can be added later if required.

## 36.6 WimaxChannel and WimaxPhy models

The module implements the Wireless MAN OFDM PHY specifications as the more relevant for implementation as it is the schema chosen by the WiMAX Forum. This specification is designed for non-light-of-sight (NLOS) including fixed and mobile broadband wireless access. The proposed model uses a 256 FFT processor, with 192 data subcarriers. It supports all the seven modulation and coding schemes specified by Wireless MAN-OFDM. It is composed of two parts: the channel model and the physical model.

### 36.7 Channel model

The channel model we propose is implemented by the class `SimpleOFDMWimaxChannel` which extends the class `wimaxchannel`. The channel entity has a private structure named `m_phyList` which handles all the physical devices connected to it. When a physical device sends a packet (FEC Block) to the channel, the channel handles the packet, and then for each physical device connected to it, it calculates the propagation delay, the path loss according to a given propagation model and eventually forwards the packet to the receiver device. The channel class uses the method `GetDistanceFrom()` to calculate the distance between two physical entities according to their 3D coordinates. The delay is computed as  $delay = distance/C$ , where  $C$  is the speed of the light.

### 36.8 Physical model

The physical layer performs two main operations: (i) It receives a burst from a channel and forwards it to the MAC layer, (ii) it receives a burst from the MAC layer and transmits it on the channel. In order to reduce the simulation complexity of the WiMAX physical layer, we have chosen to model offline part of the physical layer. More specifically





## BIBLIOGRAPHY

- [Balanis] C.A. Balanis, "Antenna Theory - Analysis and Design", Wiley, 2nd Ed.
- [Chunjian] Li Chunjian, "Efficient Antenna Patterns for Three-Sector WCDMA Systems", Master of Science Thesis, Chalmers University of Technology, Göteborg, Sweden, 2003
- [Calcev] George Calcev and Matt Dillon, "Antenna Tilt Control in CDMA Networks", in Proc. of the 2nd Annual International Wireless Internet Conference (WICON), 2006
- [R4-092042a] 3GPP TSG RAN WG4 (Radio) Meeting #51, R4-092042, Simulation assumptions and parameters for FDD HeNB RF requirements.
- [Mailloux] Robert J. Mailloux, "Phased Array Antenna Handbook", Artech House, 2nd Ed.
- [turkmani] Turkmani A.M.D., J.D. Parson and D.G. Lewis, "Radio propagation into buildings at 441, 900 and 1400 MHz", in Proc. of 4th Int. Conference on Land Mobile Radio, 1987.
- [FlowMonitor] G. Carneiro, P. Fortuna, and M. Ricardo. 2009. FlowMonitor: a network monitoring framework for the network simulator 3 (NS-3). In Proceedings of the Fourth International ICST Conference on Performance Evaluation Methodologies and Tools (VALUETOOLS '09). <http://dx.doi.org/10.4108/ICST.VALUETOOLS2009.7493> (Full text: <https://dl.acm.org/doi/abs/10.4108/ICST.VALUETOOLS2009.7493>)
- [TS25814] 3GPP TS 25.814 "Physical layer aspect for evolved Universal Terrestrial Radio Access"
- [TS29274] 3GPP TS 29.274 "GPRS Tunnelling Protocol for Control plane (GTPv2-C)"
- [TS36101] 3GPP TS 36.101 "E-UTRA User Equipment (UE) radio transmission and reception"
- [TS36104] 3GPP TS 36.104 "E-UTRA Base Station (BS) radio transmission and reception"
- [TS36133] 3GPP TS 36.133 "E-UTRA Requirements for support of radio resource management"
- [TS36211] 3GPP TS 36.211 "E-UTRA Physical Channels and Modulation"
- [TS36212] 3GPP TS 36.212 "E-UTRA Multiplexing and channel coding"
- [TS36213] 3GPP TS 36.213 "E-UTRA Physical layer procedures"
- [TS36214] 3GPP TS 36.214 "E-UTRA Physical layer – Measurements"
- [TS36300] 3GPP TS 36.300 "E-UTRA and E-UTRAN; Overall description; Stage 2"
- [TS36304] 3GPP TS 36.304 "E-UTRA User Equipment (UE) procedures in idle mode"
- [TS36321] 3GPP TS 36.321 "E-UTRA Medium Access Control (MAC) protocol specification"
- [TS36322] 3GPP TS 36.322 "E-UTRA Radio Link Control (RLC) protocol specification"
- [TS36323] 3GPP TS 36.323 "E-UTRA Packet Data Convergence Protocol (PDCP) specification"

- [TS36331] 3GPP TS 36.331 “E-UTRA Radio Resource Control (RRC) protocol specification”
- [TS36413] 3GPP TS 36.413 “E-UTRAN S1 application protocol (S1AP)”
- [TS36420] 3GPP TS 36.420 “E-UTRAN X2 general aspects and principles”
- [TS36423] 3GPP TS 36.423 “E-UTRAN X2 application protocol (X2AP)”
- [TR36814] 3GPP TR 36.814 “E-UTRA Further advancements for E-UTRA physical layer aspects”
- [R1-081483] 3GPP R1-081483 “Conveying MCS and TB size via PDCCH”
- [R4-092042] 3GPP R4-092042 “Simulation assumptions and parameters for FDD HeNB RF requirements”
- [FFAPI] FemtoForum “LTE MAC Scheduler Interface Specification v1.11”
- [ns3tutorial] “The ns-3 Tutorial”
- [ns3manual] “The ns-3 Manual”
- [Sesia2009] S. Sesia, I. Toufik and M. Baker, “LTE - The UMTS Long Term Evolution - from theory to practice”, Wiley, 2009
- [Baldo2009] N. Baldo and M. Miozzo, “Spectrum-aware Channel and PHY layer modeling for ns3”, Proceedings of ICST NSTools 2009, Pisa, Italy
- [Piro2010] Giuseppe Piro, Luigi Alfredo Grieco, Gennaro Boggia, and Pietro Camarda, “A Two-level Scheduling Algorithm for QoS Support in the Downlink of LTE Cellular Networks”, Proc. of European Wireless, EW2010, Lucca, Italy, Apr., 2010
- [Holtzman2000] J.M. Holtzman, “CDMA forward link waterfilling power control”, in Proc. of IEEE VTC Spring, 2000.
- [Piro2011] G. Piro, N. Baldo, M. Miozzo, “An LTE module for the ns-3 network simulator”, in Proc. of Wns3 2011 (in conjunction with SimuTOOLS 2011), March 2011, Barcelona (Spain)
- [Seo2004] H. Seo, B. G. Lee. “A proportional-fair power allocation scheme for fair and efficient multiuser OFDM systems”, in Proc. of IEEE GLOBECOM, December 2004. Dallas (USA)
- [Ofcom2600MHz] Ofcom, “Consultation on assessment of future mobile competition and proposals for the award of 800 MHz and 2.6 GHz spectrum and related issues”, March 2011
- [RealWireless] RealWireless, “Low-power shared access to spectrum for mobile broadband”, Final Report, Ofcom Project MC/073, 18th March 2011
- [PaduaPEM] “Ns-developers - LTE error model contribution”
- [ViennaLteSim] “The Vienna LTE Simulators”
- [LozanoCost] Joan Olmos, Silvia Ruiz, Mario García-Lozano and David Martín-Sacristán, “Link Abstraction Models Based on Mutual Information for LTE Downlink”, COST 2100 TD(10)11052 Report
- [wimaxEmd] WiMAX Forum White Paper, “WiMAX System Evaluation Methodology”, July 2008.
- [mathworks] Matlab R2011b Documentation Communications System Toolbox, “Methodology for Simulating Multipath Fading Channels”
- [CatreuxMIMO] S. Catreux, L.J. Greenstein, V. Erceg, “Some results and insights on the performance gains of MIMO systems,” Selected Areas in Communications, IEEE Journal on , vol.21, no.5, pp. 839- 847, June 2003
- [Ikuno2010] J.C. Ikuno, M. Wrulich, M. Rupp, “System Level Simulation of LTE Networks,” Vehicular Technology Conference (VTC 2010-Spring), 2010 IEEE 71st , vol., no., pp.1-5, 16-19 May 2010
- [Milos2012] J. Milos, “Performance Analysis Of PCFICH LTE Control Channel”, Proceedings of the 19th Conference STUDENT EEICT 2012, Brno, CZ, 2012.
- [FujitsuWhitePaper] “Enhancing LTE Cell-Edge Performance via PDCCH ICIC”.



- [Bharucha2011] Z. Bharucha, G. Auer, T. Abe, N. Miki, “Femto-to-Macro Control Channel Interference Mitigation via Cell ID Manipulation in LTE,” Vehicular Technology Conference (VTC Fall), 2011 IEEE , vol., no., pp.1-6, 5-8 Sept. 2011
- [R4-081920] 3GPP R4-081920 “LTE PDCCH/PCFICH Demodulation Performance Results with Implementation Margin”
- [FCapo2012] F.Capozzi, G.Piro, L.A. Grieco, G.Boggia, P.Camarda, “Downlink Packet Scheduling in LTE Cellular Networks: Key Design Issues and a Survey”, IEEE Comm. Surveys and Tutorials, vol.2012, no.99, pp.1-23, Jun. 2012
- [FABokhari2009] F.A. Bokhari, H. Yanikomeroglu, W.K. Wong, M. Rahman, “Cross-Layer Resource Scheduling for Video Traffic in the Downlink of OFDMA-Based Wireless 4G Networks”, EURASIP J. Wirel. Commun. Netw., vol.2009, no.3, pp. 1-10, Jan. 2009.
- [WKWong2004] W.K. Wong, H.Y. Tang, V.C.M, Leung, “Token bank fair queuing: a new scheduling algorithm for wireless multimedia services”, Int. J. Commun. Syst., vol.17, no.6, pp.591-614, Aug.2004.
- [GMonghal2008] G. Mongha, K.I. Pedersen, I.Z. Kovacs, P.E. Mogensen, “QoS Oriented Time and Frequency Domain Packet Schedulers for The UTRAN Long Term Evolution”, In Proc. IEEE VTC, 2008.
- [Dimou2009] K. Dimou, M. Wang, Y. Yang, M. Kazmi, A. Larmo, J. Pettersson, W. Muller, Y. Timner, “Handover within 3GPP LTE: Design Principles and Performance”, Vehicular Technology Conference Fall (VTC 2009-Fall), 2009 IEEE 70th, pp.1-5, 20-23 Sept. 2009
- [Lee2010] Y.J. Lee, B.J. Shin, J.C. Lim, D.H. Hong, “Effects of time-to-trigger parameter on handover performance in SON-based LTE systems”, Communications (APCC), 2010 16th Asia-Pacific Conference on, pp.492-496, Oct. 31 2010–Nov. 3 2010
- [Bbojovic2014] B. Bojovic, N. Baldo, “A new Channel and QoS Aware Scheduler to enhance the capacity of Voice over LTE systems”, in Proceedings of 11th International Multi-Conference on Systems, Signals & Devices (SSD'14), Castelldefels, 11-14 February 2014, Castelldefels (Spain).
- [Baldo2014] N. Baldo, R. Martínez, P. Dini, R. Vilalta, M. Miozzo, R. Casellas, R. Muñoz, “A Testbed for Fixed Mobile Convergence Experimentation: ADRENALINE-LENA Integration”, in Proceedings of European Wireless 2014, 14-16 May 2014, Barcelona (Spain).
- [ASHamza2013] Abdelbaset S. Hamza, Shady S. Khalifa, Haitham S. Hamza, and Khaled Elsayed, “A Survey on Inter-Cell Interference Coordination Techniques in OFDMA-based Cellular Networks”, IEEE Communications Surveys & Tutorials, March 19, 2013
- [ZXie2009] Zheng Xie, Bernhard Walke, “Enhanced Fractional Frequency Reuse to Increase Capacity of OFDMA Systems”, Proceedings of the 3rd international conference on New technologies, mobility and security, NTMS 2009
- [DKimura2012] D. Kimura, H. Seki, “Inter-Cell Interference Coordination (ICIC) Technology”, FUJITSU Sci. Tech. J., Vol. 48, No. 1 (January 2012)
- [And09] K. Andreev, [Realization of IEEE802.11s draft standard in NS-3.](#)
- [And10] K. Andreev and P. Boyko, [IEEE 802.11s Mesh Networking NS-3 Model.](#)
- [Hep15] C. Hepner and A. Witt and R. Muenzner, [Validation of the ns-3 802.11s model and proposed changes compliant to IEEE 802.11-2012](#), Poster at 2015 Workshop on ns-3, May 2015.
- [Hep16] C. Hepner and S. Moll and R. Muenzner, [Influence of Processing Delays on the VoIP Performance for IEEE 802.11s Multihop Wireless Mesh Networks: Comparison of ns-3 Network Simulations with Hardware Measurements](#), Proceedings of SIMUTOOLS 16, August, 2016.
- [ieee80211s] IEEE Standard for Information Technology, Telecommunications and information exchange between systems, Local and metropolitan area networks, Specific requirements, Part 11: Wireless LAN Medium

- Access Control (MAC) and Physical Layer (PHY) specifications, Amendment 10: Mesh Networking, 10 September 2011.
- [rfc3626] **RFC 3626** *Optimized Link State Routing*
- [rfc7181] **RFC 7181** *The Optimized Link State Routing Protocol Version 2*
- [friis] Friis, H.T., "A Note on a Simple Transmission Formula," Proceedings of the IRE , vol.34, no.5, pp.254,256, May 1946
- [hata] M.Hata, "Empirical formula for propagation loss in land mobile radio services", IEEE Trans. on Vehicular Technology, vol. 29, pp. 317-325, 1980
- [cost231] "Digital Mobile Radio: COST 231 View on the Evolution Towards 3rd Generation Systems", Commission of the European Communities, L-2920, Luxembourg, 1989
- [walfisch] J.Walfisch and H.L. Bertoni, "A Theoretical model of UHF propagation in urban environments," in IEEE Trans. Antennas Propagat., vol.36, 1988, pp.1788- 1796
- [ikegami] F.Ikegami, T.Takeuchi, and S.Yoshida, "Theoretical prediction of mean field strength for Urban Mobile Radio", in IEEE Trans. Antennas Propagat., Vol.39, No.3, 1991
- [kun2600mhz] Sun Kun, Wang Ping, Li Yingze, "Path loss models for suburban scenario at 2.3GHz, 2.6GHz and 3.5GHz", in Proc. of the 8th International Symposium on Antennas, Propagation and EM Theory (ISAPE), Kunming, China, Nov 2008.
- [Boban2016Modeling] M. Boban, X. Gong, and W. Xu, "Modeling the evolution of line-of-sight blockage for V2V channels," in IEEE 84th Vehicular Technology Conference (VTC-Fall), 2016.
- [Baldo2009Spectrum] N. Baldo and M. Miozzo, "Spectrum-aware Channel and PHY layer modeling for ns3", Proceedings of ICST NSTools 2009, Pisa, Italy
- [Baron8VSB] Baron, Stanley. "First-Hand:Digital Television: The Digital Terrestrial Television Broadcasting (DTTB) Standard." IEEE Global History Network. <[http://www.ieeeahn.org/wiki/index.php/First-Hand:Digital\\_Television:\\_The\\_Digital\\_Terrestrial\\_Television\\_Broadcasting\\_\(DTTB\)\\_Standard](http://www.ieeeahn.org/wiki/index.php/First-Hand:Digital_Television:_The_Digital_Terrestrial_Television_Broadcasting_(DTTB)_Standard)>.
- [KoppCOFDM] Kopp, Carlo. "High Definition Television." High Definition Television. Air Power Australia. <<http://www.airspacepower.net/AC-1100.html>>.
- [MatlabGeo] "Geodetic2ecef." Convert Geodetic to Geocentric (ECEF) Coordinates. The MathWorks, Inc. <<http://www.mathworks.com/help/map/ref/geodetic2ecef.html>>.
- [QualcommAnalog] Stephen Shellhammer, Ahmed Sadek, and Wenyi Zhang. "Technical Challenges for Cognitive Radio in the TV White Space Spectrum." Qualcomm Incorporated.
- [TR38901] 3GPP. 2018. TR 38.901. Study on channel for frequencies from 0.5 to 100 GHz. V.15.0.0. (2018-06).
- [Zhang] Menglei Zhang, Michele Polese, Marco Mezzavilla, Sundeep Rangan, Michele Zorzi. "ns-3 Implementation of the 3GPP MIMO Channel Model for Frequency Spectrum above 6 GHz". In Proceedings of the Workshop on ns-3 (WNS3 '17). 2017.
- [Zugno] Tommaso Zugno, Michele Polese, Natale Patriciello, Biljana Bojovic, Sandra Lagen, Michele Zorzi. "Implementation of a Spatial Channel Model for ns-3". Submitted to the Workshop on ns-3 (WNS3 '20). 2020. Available: <https://arxiv.org/abs/2002.09341>
- [IANA802] IANA, assigned IEEE 802 numbers: <http://www.iana.org/assignments/ieee-802-numbers/ieee-802-numbers.xml>
- [Ethertype] IEEE Ethertype numbers: <http://standards.ieee.org/develop/regauth/ethertype/eth.txt>
- [Shelby] 26. Shelby and C. Bormann, 6LoWPAN: The Wireless Embedded Internet. Wiley, 2011. [Online]. Available: <https://books.google.it/books?id=3Nm7ZCxcMQC>

- [Ref1] A. Kuznetsov and D. Torokhov; Linux Cross Reference Source Code; Available online at [http://lxr.free-electrons.com/source/net/sched/sch\\_tbf.c](http://lxr.free-electrons.com/source/net/sched/sch_tbf.c).
- [Ref2] J. Vehent; Journey to the Center of the Linux Kernel: Traffic Control, Shaping and QoS; Available online at [http://wiki.linuxwall.info/doku.php/en:resources:dossiers:networking:traffic\\_control#tbf\\_-\\_token\\_bucket\\_filter](http://wiki.linuxwall.info/doku.php/en:resources:dossiers:networking:traffic_control#tbf_-_token_bucket_filter).
- [Ref3] Practical IP Network QoS: TBF queuing discipline; Available online at <http://web.opalsoft.net/qos/default.php?p=ds-24>.
- [Nic12] K. Nichols and V. Jacobson, Controlling Queue Delay, ACM Queue, Vol. 10 No. 5, May 2012. Available online at <http://queue.acm.org/detail.cfm?id=2209336>.
- [Nic14] K. Nichols and V. Jacobson, Internet-Draft: Controlled Delay Active Queue Management, March 2014. Available online at <http://tools.ietf.org/html/draft-nichols-tsvwg-codel-02>.
- [Buf14] Bufferbloat.net. Available online at <http://www.bufferbloat.net/>.
- [Hoe16] T. Hoeiland-Joergensen, P. McKenney, D. Taht, J. Gettys and E. Dumazet, The FlowQueue-CoDel Packet Scheduler and Active Queue Management Algorithm, IETF draft. Available online at <https://tools.ietf.org/html/draft-ietf-aqm-fq-codel>
- [Buf16] Bufferbloat.net. Available online at <http://www.bufferbloat.net/>.
- [Cake16] Linux implementation of Cobalt as a part of the cake framework. Available online at [https://github.com/dtaht/sch\\_cake/blob/master/cobalt.c](https://github.com/dtaht/sch_cake/blob/master/cobalt.c).
- [Kath17] Controlled Delay Active Queue Management (draft-ietf-aqm-fq-codel-07) Available online at <https://tools.ietf.org/html/draft-ietf-aqm-codel-07>.
- [BLUE02] Feng, W. C., Shin, K. G., Kandlur, D. D., & Saha, D. (2002). The BLUE Active Queue Management Algorithms. IEEE/ACM Transactions on Networking (ToN), 10(4), 513-528.
- [Cobalt19] Jendaipou Palmei, Shefali Gupta, Pasquale Imputato, Jonathan Morton, Mohit P. Tahiliani, Stefano Avalone and Dave Taht (2019). Design and Evaluation of COBALT Queue Discipline. IEEE International Symposium on Local and Metropolitan Area Networks (LANMAN), July 2019.
- [Pan13] Pan, R., Natarajan, P., Piglione, C., Prabhu, M. S., Subramanian, V., Baker, F., & VerSteeg, B. (2013, July). PIE: A lightweight control scheme to address the bufferbloat problem. In High Performance Switching and Routing (HPSR), 2013 IEEE 14th International Conference on (pp. 148-155). IEEE. Available online at <https://www.ietf.org/mail-archive/web/iccr/current/pdfB57AZSheOH.pdf>.
- [Pan16] R. Pan, P. Natarajan, F. Baker, G. White, B. VerSteeg, M.S. Prabhu, C. Piglione, V. Subramanian, Internet-Draft: PIE: A lightweight control scheme to address the bufferbloat problem, April 2016. Available online at <https://tools.ietf.org/html/draft-ietf-aqm-pie-07>.
- [ieee80211p] IEEE Std 802.11p-2010 “IEEE Standard for Information technology– Local and metropolitan area networks– Specific requirements– Part 11: Wireless LAN Medium Access Control (MAC) and Physical Layer (PHY) Specifications Amendment 6: Wireless Access in Vehicular Environments”
- [ieee1609dot1] IEEE Std 1609.1-2010 “IEEE Standard for Wireless Access in Vehicular Environments (WAVE) - Resource Manager, 2010”
- [ieee1609dot2] IEEE Std 1609.2-2010 “IEEE Standard for Wireless Access in Vehicular Environments (WAVE) - Security Services for Applications and Management Messages, 2010”
- [ieee1609dot3] IEEE Std 1609.3-2010 “IEEE Standard for Wireless Access in Vehicular Environments (WAVE) - Networking Services, 2010”
- [ieee1609dot4] IEEE Std 1609.4-2010 “IEEE Standard for Wireless Access in Vehicular Environments (WAVE) - Multi-Channel Operation, 2010”
- [saej2735] SAE Std J2735 “J2735 dedicated short range communications (DSRC) message set dictionary. 2009”

- [ieee80211] IEEE Std 802.11-2012, *Part 11: Wireless LAN Medium Access Control (MAC) and Physical Layer (PHY) Specifications*
- [ieee80211-2016] IEEE Std 802.11-2016, *Part 11: Wireless LAN Medium Access Control (MAC) and Physical Layer (PHY) Specifications*
- [pei80211b] G. Pei and Tom Henderson, [Validation of ns-3 802.11b PHY model](#)
- [pei80211ofdm] G. Pei and Tom Henderson, [Validation of OFDM error rate model in ns-3](#)
- [lacage2006yans] M. Lacage and T. Henderson, [Yet another Network Simulator](#)
- [Haccoun] D. Haccoun and G. Begin, *High-Rate Punctured Convolutional Codes for Viterbi Sequential Decoding*, IEEE Transactions on Communications, Vol. 32, Issue 3, pp.315-319.
- [Frenger] Pål Frenger et al., “Multi-rate Convolutional Codes”.
- [ji2004sslswn] Z. Ji, J. Zhou, M. Takai and R. Bagrodia, *Scalable simulation of large-scale wireless networks with bounded inaccuracies*, in Proc. of the Seventh ACM Symposium on Modeling, Analysis and Simulation of Wireless and Mobile Systems, October 2004.
- [linuxminstrel] [minstrel linux wireless](#)
- [lacage2004aarfamrr] M. Lacage, H. Manshaei, and T. Turletti, *IEEE 802.11 rate adaptation: a practical approach*, in Proc. 7th ACM International Symposium on Modeling, Analysis and Simulation of Wireless and Mobile Systems, 2004.
- [kim2006cara] J. Kim, S. Kim, S. Choi, and D. Qiao, *CARA: Collision-Aware Rate Adaptation for IEEE 802.11 WLANs*, in Proc. 25th IEEE International Conference on Computer Communications, 2006
- [wong2006rraa] S. Wong, H. Yang, S. Lu, and V. Bharghavan, *Robust Rate Adaptation for 802.11 Wireless Networks*, in Proc. 12th Annual International Conference on Mobile Computing and Networking, 2006
- [maguolo2008aarfcd] F. Maguolo, M. Lacage, and T. Turletti, *Efficient collision detection for auto rate fallback algorithm*, in IEEE Symposium on Computers and Communications, 2008
- [proakis2001] J. Proakis, *Digital Communications*, Wiley, 2001.
- [miller2003] L. E. Miller, “Validation of 802.11a/UWB Coexistence Simulation.” Technical Report, October 2003. Available [online](#)
- [ferrari2004] G. Ferrari and G. Corazza, “Tight bounds and accurate approximations for DQPSK transmission bit error rate”, *Electronics Letters*, 40(20):1284-85, September 2004.
- [pursley2009] M. Pursley and T. Royster, “Properties and performance of the IEEE 802.11b complementary code key signal sets,” *IEEE Transactions on Communications*, 57(2):440-449, February 2009.
- [akella2007parf] A. Akella, G. Judd, S. Seshan, and P. Steenkiste, ‘Self-management in chaotic wireless deployments’, in *Wireless Networks*, Kluwer Academic Publishers, 2007, 13, 737-755. <http://www.cs.odu.edu/~nadeem/classes/cs795-WNS-S13/papers/enter-006.pdf>
- [chevillat2005aparf] Chevillat, P.; Jelitto, J., and Truong, H. L., ‘Dynamic data rate and transmit power adjustment in IEEE 802.11 wireless LANs’, in *International Journal of Wireless Information Networks*, Springer, 2005, 12, 123-145. [http://www.cs.mun.ca/~yzchen/papers/papers/rate\\_adaptation/80211\\_dynamic\\_rate\\_power\\_adjustment\\_chevillat\\_j2005.pdf](http://www.cs.mun.ca/~yzchen/papers/papers/rate_adaptation/80211_dynamic_rate_power_adjustment_chevillat_j2005.pdf)
- [hepner2015] C. Hepner, A. Witt, and R. Muenzner, “In depth analysis of the ns-3 physical layer abstraction for WLAN systems and evaluation of its influences on network simulation results”, *BW-CAR Symposium on Information and Communication Systems (SInCom) 2015*. <https://core.ac.uk/download/pdf/75487102.pdf#page=50>
- [baldo2010] N. Baldo et al., “Validation of the ns-3 IEEE 802.11 model using the EXTREME testbed”, *Proceedings of SIMUTools Conference*, March 2010.

- [lanante2019] L. Lanante Jr. et al., “Improved Abstraction for Clear Channel Assessment in ns-3 802.11 WLAN Model”, Proceedings of the 2019 Workshop on ns-3, June 2019.
- [bianchi2000] G. Bianchi, “Performance analysis of the IEEE 802.11 distributed coordination function”, IEEE Communications Letters, 18(3):535–547, 2000.
- [bianchi2005] G. Bianchi and I. Tinnirello. “Remarks on IEEE 802.11 DCF performance analysis”, IEEE Communications Letters, 9(8):765–767, 2005.
- [patidar2017] R. Patidar et al., “Link-to-System Mapping for ns-3 Wi-Fi OFDM Error Models”, Proceedings of the Workshop on ns-3, June 2017. <https://dl.acm.org/doi/10.1145/3067665.3067671>
- [erceg2004] V. Erceg and L. Schumacher and P. Kyritsi, “Tgn channel models”, IEEE 802.11-03/940r4, 2004.
- [porat2016] R. Porat et al., “11ax Evaluation Methodology”, IEE P802.11 Wireless LANs, 11-14-0571r3, 2016.



## R

### RFC

- RFC 1058, 108, 109
- RFC 1723, 108
- RFC 1918, 93
- RFC 2080, 105, 108, 109
- RFC 2131, 155
- RFC 2132, 155
- RFC 2453, 105, 108
- RFC 3393, 82
- RFC 3561, 17, 105
- RFC 3626, 105, 413, 566
- RFC 4728, 59, 62
- RFC 4944, 453, 455
- RFC 6282, 453, 455
- RFC 6621, 96
- RFC 6775, 453, 455
- RFC 6928, 112
- RFC 7181, 413, 566
- RFC 8312, 117